

FESTO

Product overview 2025/26

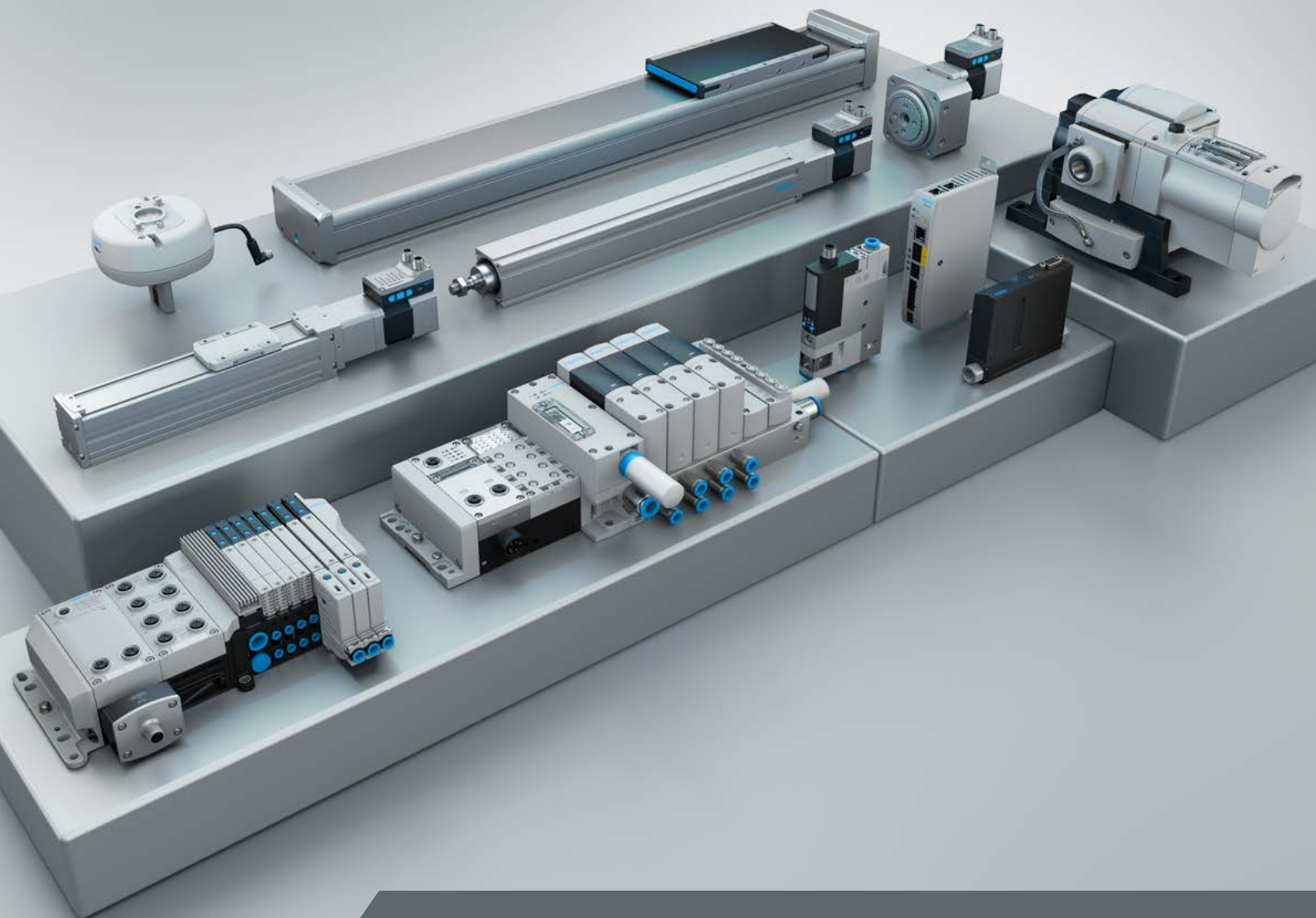



Product overview 2025/26





















Issue 2025/10

All technical data are correct at the time of going to print.

All content, texts, representations, illustrations and drawings included in this catalogue are the intellectual property of Festo SE & Co. KG and are protected by copyright law. No part of this publication may be reproduced, processed, translated or transmitted in any form or by any means, electronic, mechanical, photocopying or otherwise, without the prior written permission of Festo SE & Co. KG.

All technical data are subject to change according to technical updates.

Festo SE & Co. KG
Postfach
73726 Esslingen
Ruiter Strasse 82
73734 Esslingen
Germany

	Editorial	3	⊙	
	Actuators	Pneumatic cylinders	17	01
		Servo-pneumatic positioning systems	49	02
		Electromechanical actuators	55	03
		Pneumatic drives for process valves	69	04
	Motors and servo drives	79	05	
	Grippers	87	06	
	Handling systems and industrial robots	97	07	
	Vacuum technology	103	08	
	Valves and valve terminals	Valves	111	09
		Valve terminals	159	10
	Motion Terminal	173	11	
	Sensors	179	12	
	Compressed air preparation	199	13	
	Tubes, fittings, plugs and cables	Electrical connection technology	221	14
		Pneumatic connection technology	241	15
	Control technology and remote I/O	263	16	
	Software	273	17	
	Ready-to-install solutions	279	18	
	Function-specific systems	283	19	
	Other pneumatic components	287	20	
	Services	291	21	
	Appendix	293	⊙	



Preface



100 years

Automation for a world in motion.

Dear distributor, dear customer,

We are pleased to be able to present our new catalogue for 2025 – a very special year for us. We are celebrating **100 years of Festo!** This catalogue is full of innovations. We combine the strengths of pneumatics and electrics with digital applications and artificial intelligence, rounded off by comprehensive training courses. Regardless of the kind of industrial motion you are planning, as an innovation leader, we will find the right solution for your requirements.

Our **seamless automation** provides you with special added value. Thanks to the open system architecture, electric and pneumatic systems can be controlled in one solution and seamlessly integrated into your machines and systems. You choose the technology you need to increase the efficiency of your production, and Festo, as a one-stop shop, offers you everything from a single source.

Digitalisation and AI are used to optimise design, operation and maintenance. And software solutions, tools and services are available for the entire automation pyramid, from predictive maintenance and digital twins to Festo AX Industrial Intelligence. This results in shorter downtimes, fewer rejects, reduced leakage, while also adding a valuable contribution to quality assurance and energy efficiency.

But technological innovation alone is not enough. It needs requires people to further develop and apply it. Festo Didactic is a global leader in basic and further technical training and your strong partner for developing technical competencies. Be it with customised learning packages, digital platforms or complete training centres, Festo Didactic stands for **lifelong learning**.

We are also setting the standards in terms of **sustainability**: As part of the Science Based Targets initiative (SBTI), we are committed to climate targets that are in line with the Paris Agreement. We are continuously working to reduce CO₂ and create resource-saving solutions at all our sites and along the entire supply chain. Together with our customers, we are making an active contribution to a sustainable and circular economy, making automation a driving force for climate protection.

100 years of Festo represent our motivation to continue making automation simpler and more efficient for you in the future. We invite you to: Discover our comprehensive product portfolio in the new catalogue and use our digital engineering tools to make your projects even more efficient. If you have any questions or are interested in more information, please do not hesitate to contact us.

I hope you enjoy looking through it!



Frank Notz
Member of the Management Board Sales at Festo SE & Co. KG

Digital products and services

Comprehensive digitalisation concepts: AI becomes the new standard

All our development activities for digitalised automation revolve around one question: how can we make you more productive along the entire value chain?

From initial engineering, procurement and commissioning to maintenance and operation? At Festo you will find the right digital offer for your needs.

Below you will see a selection that we have compiled for you.

AI in production with industrial intelligence

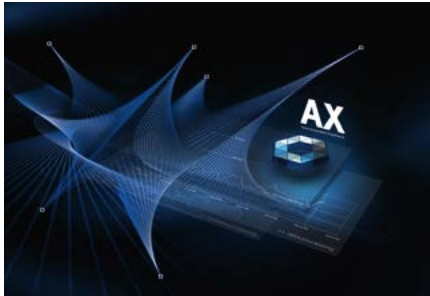

Do you want to avoid unplanned downtime, ensure product quality and reduce energy costs? Festo AX industrial intelligence allows companies to collect real-time data from production and analyze it using artificial intelligence (AI). The use of artificial intelligence allows for predictive maintenance, ensures product quality (predictive quality) and uses resources more efficiently (predictive energy).

With Festo AX you can reduce downtimes by 25%, cut waste by 20% and reduce leakages by up to 65%..

The Festo AX AI software helps you ...

- reduce unplanned downtime with predictive maintenance
- ensure product quality with predictive quality
- minimize energy costs with predictive energy

→ www.festo.com/AX

Pneumatic Simulation



Perhaps you have also asked yourself whether it possible to calculate the one optimal pneumatic control chain more quickly and accurately? Yes, it is! With Pneumatic Sizing, you are offered not just one, but up to three design variants to suit your application.

Pneumatic Simulation allows you to benefit from:

- optimal air consumption
- the ideal travel time per cycle
- direct connections to the Festo Online Shop

When you enter three application parameters, such as mass, stroke and positioning time, you receive up to three suggestions: the exact result, the performance variant and the eco variant.

→ www.festo.com/x/pneumatic-simulation

Festo Design Tool 3D



Festo Design Tool 3D is a 3D product configurator for creating Festo-specific CAD product combinations. Your search for suitable accessories for standard components that can be delivered quickly, such as the pneumatic cylinder series DSBC, DSNU and ADN, will therefore be faster, safer and easier in the future. At the same time, there will be less effort involved with documentation as well as easy traceability.

Benefits for design, purchasing, and initial commissioning:

- fast, simple automated generation of product combinations
- shorter bills of materials, reduced error sources and optimized ordering processes
- native CAD models to preserve CAD/component links (CAD constraints, CAD mates)
- simplified, accelerated processes in the warehouse and during assembly

→ www.festo.com/fdt-3D

CO2 & TCO Guide



Before choosing the technology for your system, you should make sure you know how high the CO2 consumption will be during operation and what you can expect the total cost of ownership (TCO) to be in the future.

total cost of ownership and thus provides you will all the key factors as a valuable decision-making support.

Our CO2 TCO tool enables you to compare electric and pneumatic drives from our product portfolio. It provides a clear comparison of the energy consumption, CO2 emissions, the procurement costs and the

- guide for selecting the right technology
- comparison of pneumatic and electric drives
- comparison of energy consumption, CO2 emissions, procurement costs and total cost of ownership

→ www.festo.com/x/co2-tco

Simplified Motion Series – Solution Finder



→ www.festo.com/x/simplified-motion-series

For the first time, the simplicity of pneumatics is now combined with the advantages of electric automation thanks to the Simplified Motion Series. These integrated drives are the perfect solution for all users who are looking for an electric alternative for very simple movement and positioning tasks, but don't want the commissioning process for traditional electric drive systems that can often be quite complex.

- configure the right product for any simple linear or rotary movement.
- select the product and order it in the Online Shop.

Schematic Solution for EPLAN projects



→ www.festo.com/x/eplan-app

This circuit diagram service is only available from Festo: Schematic Solution for EPLAN projects documents your configured solutions comprehensively and at lightning speed! Just enter the order code and receive the complete plan in just a few minutes – reliably and error-free. Instead of tedious searches and downloading and piecing together all the individual components yourself, all the hard work has already been done for you, reducing the time it takes from several hours to just a few minutes

- intuitive, fast and secure: Error-free documentation at the touch of a button
- a full mechatronic representation of configured products such as CPX, VTSA, MPA
- safely automated according to standards IEC 61355, IEC 81346, ISO 1219

FluidDraw – circuit diagrams for complete systems



→ www.festo.com/fluiddraw

Planning and documenting electric and pneumatic components in your system have never been easier. FluidDraw gives you direct access to the catalogue and any online baskets you saved at Festo, as well as letting you import additional databases and use a standardised symbol library. For maximum convenience choose the FluidDraw 365 software subscription with regular updates and the latest upgrades.

- IMX and Eplan interfaces
- Tubing lengths, wire and cable lengths
- Standardised hydraulic symbols to ISO 1219

Configurator for process valve units and quarter turn actuator units



→ www.festo.com/kvza

→ www.festo.com/kvzb

→ www.festo.com/catalogue/kdfp-dfpd

The configurator for process valve units (KVZA and KVZB) and quarter turn actuator units (KDFP-DFPD) significantly simplifies engineering and procurement processes. The tool ensures quick and successful project management by taking all relevant factors into account: from initial product search, configuration, sizing and documentation right through to ordering and delivery of the ready-to-install units – everything is combined in one tool, including customer-specific requests.

All components come from a single source, are pre-assembled and perfectly compatible with each other.

- Tailored and ready-to-install solutions
- Increased reliability for your specific application
- CAD data for configuration and documentation for direct download
- The system ID can also be used for subsequent orders
- Reliable planning with immediate price and delivery time information

You can find more tools in our overview

→ www.festo.com/engineering-tools

VTUX valve terminal – the versatile valve terminal

A modern design and seamless integration into the AP platform enable unprecedented flexibility. The high-performance and future-oriented VTUX valve terminal platform is the right choice from the ground up.

- Highly modular and featuring Festo AP communication technology – the new standard for higher performance and lower costs
- All requirements for predictive maintenance, security features and data exchange in the cloud (IIOT) integrated
- Compact and lightweight, saving time, space and weight in the machine
- Ideal for centralized and decentralized machine concepts

“Our new VTUX valve terminal is a milestone.”

Dr. Ansgar Kriwet, Member of the Management Board
Research and Development, Festo

Electric



Infrastructure for technology modules – the new remote I/O system CPX-AP-A

Serial modular remote I/O in protection class IP65/67

- Real-time communication via Ethernet-based fieldbus and internal AP communication
- Direct connection of input and output signals (digital and analog) with connection technology for every application (M8, M12, terminal strip)
- Wide range of options for voltage supply and power transmission
- Interface for application programming



Integrated, space-saving switching position feedback directly assigned to the valve position

Digital inputs with internal serial links

- Detachable adapter plug M8 (IP6x) for extremely high packing density and easy installation, terminal strip option available (IP40)
- PNP or NPN
- 2 inputs per valve position
- For four-way valve manifold plate

Pneumatic

Vacuum solutions with air saving function

Complete vacuum integration for individual configuration

- Vacuum and ejector pulse can be individually controlled
- Solutions for high vacuum or high vacuum flow
- Two power levels with a grid dimension of 12.5 mm:
Nominal width 0.7 mm/1.0 mm
- Vacuum only terminal or mixed with pressure switching valves

You can find more information at:

→ www.festo.com/vtux

Sustainable Automation

Reducing CO₂ emissions to combat climate change

Thinking in terms of generations as well as long-term and responsible management are deeply rooted in the Festo family business

Festo has been driving the topic of energy efficiency forward in every area for decades – in its own company, through research projects, in cross-industry committees and with a range of solutions geared towards sustainability.

Sustainability is an integral part of the corporate strategy and a clear guiding principle for sustainable action with the action areas of reducing the CO₂ footprint, capability shift and basic and further technical training.

Reducing the CO₂ footprint

At Festo, sustainability is a team effort. Every area of the company is affected, not to mention suppliers and customers.

Since 2024, the entire Festo Group has been CO₂-compensated in Scope 1 and is already CO₂-neutral in the Scopes 2 and 3.8 – two years earlier than planned. Festo also plans to reduce Scope 1 emissions by approx. 2030 approx. 30% and to achieve the net zero target by 2040.

95% of all CO₂ emissions are generated during the usage phase of the products (Scope 3). Having the right portfolio with CO₂-optimized products together with needs-based advice throughout the entire usage phase is the way forward for Festo and its customers in achieving a sustainable future.



The **Festo Sustainability Report** provides annual information on the sustainable development of the company. Scan the code to read the latest edition.
 → www.festo.com/sustainability-report

Capability Shift

Megatrends such as sustainability, demographic change, and digitalization are leading to changes in market requirements and will also change the way companies work.

Together with its employees, Festo is embarking on a continuous learning journey aimed at remaining an attractive employer for new talent and providing systematic training for its employees at an early stage.

Social competence is just as important as technical ability for employees.

That means that respect for human rights throughout the Festo Group is an integral part of Festo's sustainability strategy.



“Together with all our employees, we will continue to be a company oriented towards technology and innovation-oriented in the future, driving sustainable change for ourselves and our customers.”

Dr. Sebastian Beck, Member of the Management Board Finance and Human Resources, Festo



You can find out more about the Capability Shift initiative in the video here: → www.festo.com/peopleatfesto



“We can only enable the CO₂-neutral production of the future by working together with our customers.”

Julia Bikidis, Head of Corporate Sustainability, Festo



You can find out more about the CO₂ reduction initiative here in the video:
→ www.festo.com/sustainability



CO₂ savings worldwide

Festo has been investing in generating its own electricity using photovoltaic systems (PV) since 2004. PV systems were added at 20 additional locations in 2023.

The total PV output installed at Festo has therefore been increased by over 60%, now totaling 13.8 megawatt peak. At the end of 2023, all PV systems around the world generated a total of 15,651 megawatt hours of electricity.

As a result, 10,600 tonnes of CO₂ per year were avoided in the systems of the respective electricity suppliers.

Basic and further technical training

Environmentally friendly skills – green skills – will be relevant for all professions in the future. Technical professionals in every industry need to develop an environmentally conscious mindset that will have a positive impact on the ecological footprint of their employers, partners, and customers.

The basic and further training program offered by Festo Didactic provides sustainable qualification solutions, starting with vocational training and continuing through to university and into the professional world. In the areas relevant to the sustainability of water management, sustainable production, the generation of renewable energies and the production of electric vehicles and batteries, Didactic supports customers in developing a qualified workforce.



“Our new innovative teaching and learning concepts help us support our customers in shaping a sustainable future.”

Dr. Oliver Niese, Member of the Board Festo Didactic



You can find out more about technical basic and further education in the video here: → www.festo.com/sustainableeducation

Sustainable Automation

Product shopping cart for CO₂ reduction

Pneumatic and electrical automation solutions are available to machine and system manufacturers for realizing automation tasks.

Bringing pneumatics and electrics together through smart innovations makes it possible to provide technology-neutral advice and efficiently design customer applications, while saving as much CO₂ emissions as possible. Accompanying services are available throughout the entire usage phase.

It is possible to opt for one solution or to combine pneumatics and electrics so that the solution is tailored precisely to requirements and combines energy efficiency and costs over the entire usage phase.

Festo offers support to its customers in four core areas to achieve greater sustainability in automation:

1. Engineering for greater energy efficiency

The design of a machine or system lays the foundation for the lowest possible CO₂ footprint. Festo offers supports in selecting the right components in the right dimensions with free engineering tools such as “Pneumatic dimensioning” and the “CO₂ & TCO Guide”, which make the energy consumption transparent during product usage, thereby enabling the optimum design of a machine or system.

2. Products for sustainable operation

Product-related considerations, including an assessment of the resulting CO₂ emissions, are an integral part of the Festo strategy. Festo sees the key to a CO₂-neutral future in the consistent further development of its products with innovative solutions.

The blue path to higher efficiency

Your way to zero emissions



Festo Energy Saving Services: In 2023, 425 projects were carried out worldwide with a calculated CO₂ savings potential totaling 20,974 metric tons.

3. Save more energy with Festo Services

In the usage phase of the products, the aim is to keep energy consumption at an optimum level over the long term and to identify deviations at an early stage. Digital solutions for energy monitoring and Festo Energy Saving Services, a compressed air energy efficiency audit that is carried out worldwide and is TÜV-certified, offer support for the manufacturing industry.

4. Sustainability in basic and further training

Festo Didactic, the world’s leading specialist in the field of technical education, provides the specialists of today and tomorrow with the awareness and skills they need to discover and consistently harness potential savings in their work.



Product shopping cart for CO₂ reducing:
You can find the product selection in the Online store via the filter "Specific catalogs > Sustainability".

Examples of...

...lighter weight products

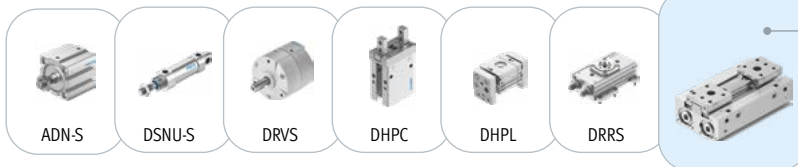

Parallel gripper

HPPF

Sustainable in production
thanks to a reduced material usage and sustainable operation thanks to integrated control with energy savings of up to 80%.

...products with energy-saving function



Vacuum generator

OVEM

Up to 60% less energy consumption: The intelligent OVEM vacuum generator ensures a secure hold and avoids permanent air consumption thanks to an air-saving circuit.

Energy efficiency module

MSE6-C2M

Regulates the compressed air supply when the system is at a standstill, prevents waste due to any leaks, monitors the flow rate and pressure. Integrated predictive energy management in combination with the AI software solution "Festo AX" enables energy savings of up to 70%.

Optimizing the pressure level

On the Festo website, you will find energy-saving tips for pneumatic and electric automation solutions such as "Optimizing the pressure level". By reducing the network pressure by 1 bar, you can save up to 10% on energy. The shopping cart also includes **the new pressure control valve MS-LR-B** (see chapter on compressed air treatment) – lightweight and robust thanks to modern polymer materials. If individual applications require higher pressure levels at certain points, this can be achieved by using a decentralized solution such as the DPA pressure booster.

Wide range of industry segments – one competent partner.

Food, drink and packaging industry



From continuous processes, and food and splash zones to end line packaging:

- Solutions for controlling special media flows
- Automation components in easy-to-clean design and with food-safe materials
- Handling systems with suitable gripper solutions
- Technology mix: electric, pneumatic and servo-pneumatic

→ www.festo.com/food

Automotive and tier-1 supplier industry



- Flexible automation solutions for electromobility
- Intelligent and energy-efficient technologies
- Safety-related concepts and components
- Matching product portfolio – electric, pneumatic, servo-pneumatic
- Engineering and industry competencies along the entire process chain

→ www.festo.com/automotive

Small parts assembly and electronics industry



Expertise along the entire process chain:

- From wafer production at the front end to finished chips at the back end
- For quality inspection and assembly of the finished products
- In small parts assembly, electronics or non-electronics

→ www.festo.com/electronics

Wide range of industry segments – one competent partner.

LifeTech – technologies for the life sciences



- Delivery of automation components for key processes:
 - Laboratory automation
 - Medical technology
 - In vitro diagnostics
 - Point-of-care applications
- Kinematics for sample handling
- Liquid handling with dispensing and pipetting systems
- Precise regulation of medical gases

→ www.festo.com/lifetech

Biotech, pharma and cosmetics industry

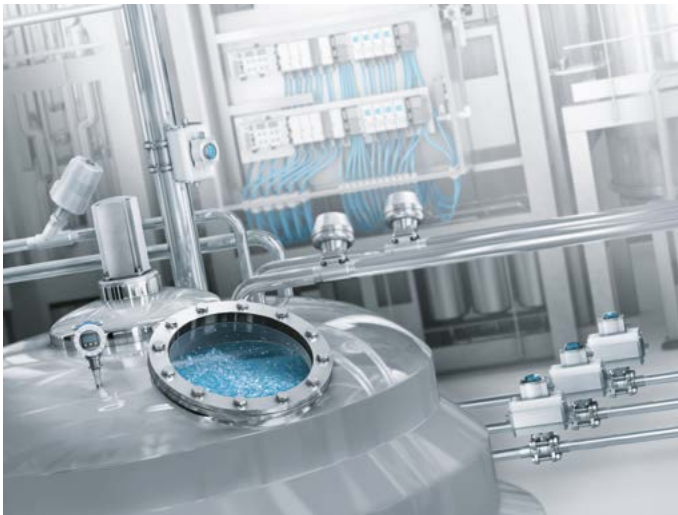

- Delivery of automation components for key processes:
 - API manufacturing
 - Manufacturing pharmaceuticals, cosmetics and personal care products
 - Filling and packaging
- Customer-oriented consulting and engineering
- Compressed air quality analyses
- Energy Saving Services

→ www.festo.com/biotech

Water treatment



- Delivery of automation components for key processes:
 - Water treatment
 - Wastewater treatment
- Customer-oriented consulting and engineering
- Compressed air quality analyses
- Energy Saving Services

→ www.festo.com/water



Product overview

01 Software tools

Pneumatic cylinders

Pneumatic sizing



Dimension pneumatic control loop systems quickly and energy-efficiently. In order to survive in a fiercely competitive environment, many companies are looking for potential savings in their production.

They also find these in their compressed air systems and equipment, most of which have been in place for years. Up to 60% energy costs can be saved here through optimization at the hall and plant level.

This tool can be found at
[→ www.festo.com/x/pneumatic-sizing](http://www.festo.com/x/pneumatic-sizing)

Air consumption of the cylinders



Calculate your system's air consumption. Calculate your system's air consumption quickly and conveniently. Simply enter all the actuators and tubing, set the cycle times and working pressure and the air consumption per minute and per day will be calculated for you. The input table including the result can be exported directly to Excel.

This tool can be found at
[→ www.festo.com/x/air-consumption](http://www.festo.com/x/air-consumption)

Pneumatic simulation



Perfect simulations replace expensive real-life tests! The tool is an expert system that supports you in the selection and configuration of the entire pneumatic control chain. If one parameter is changed, the program automatically adapts all the others.

This tool can be found at
[→ www.festo.com/x/pneumatic-simulation](http://www.festo.com/x/pneumatic-simulation)

Festo Design Tool 3D



Festo Design Tool 3D is a 3D product configurator for generating specific CAD product combinations from Festo. The configurator makes your search for the right accessory quicker, easier and more reliable

Then you can order the module created as a single order item, either completely pre-assembled or as individual parts in a box. This significantly reduces your bill of materials, and simplifies downstream processes such as product ordering, order picking and assembly.

This tool can be found at
[→ www.festo.com/fdt-3D](http://www.festo.com/fdt-3D)

CO2 values and TCO Guide







CO2 values and TCO for your application.

Take a quantum leap in automation technology. By using suitable components from Festo in an intelligent way, you can lower the energy consumption of your systems, thereby making targeted reductions to your production's carbon emissions.

This tool can be found at
[→ www.festo.com/x/co2-tco](http://www.festo.com/x/co2-tco)

Piston rod cylinders >





Round cylinders

	 Standards-based cylinder DSNU	 Round cylinders DSNU	 Round cylinders DSNU-S	 Standards-based cylinder CRDSNU, CRDSNU-B
Mode of operation	Double-acting	Double-acting	Double-acting	Double-acting
Piston diameter	8, 10, 12, 16, 20, 25	32, 40, 50, 63	8, 12, 16, 20, 25	12, 16, 20, 25
Theoretical force at 0.6 MPa (6 bar, 87 psi), advance	23 ... 295 N	482.5 ... 1870.3 N	30.2 ... 294.5 N	68 ... 295 N
Stroke	1 ... 500 mm	1 ... 500 mm	1 ... 200 mm	1 ... 500 mm
Cushioning	Elastic cushioning rings/pads at both ends, Self-adjusting pneumatic end-position cushioning, Pneumatic cushioning, adjustable at both ends	Elastic cushioning rings/pads at both ends, Self-adjusting pneumatic end-position cushioning, Pneumatic cushioning, adjustable at both ends	Elastic cushioning rings/pads at both ends, Self-adjusting pneumatic end-position cushioning	Elastic cushioning rings/pads at both ends, Self-adjusting pneumatic end-position cushioning, Pneumatic cushioning, adjustable at both ends
Description	<ul style="list-style-type: none"> • ISO 6432 • Wide range of variants for customized applications • Good running performance and long service life • Self-adjusting pneumatic end-position cushioning saves time during commissioning and adapts optimally to load and speed changes • Piston rod with internal or external thread • Magnetic piston for position sensing • Variants recommended for production facilities for the manufacture of lithium-ion batteries 	<ul style="list-style-type: none"> • Wide range of variants for customized applications • Good running performance and long service life • Self-adjusting pneumatic end-position cushioning saves time during commissioning and adapts optimally to load and speed changes • Piston rod with internal or external thread • Magnetic piston for position sensing • Variants recommended for production facilities for the manufacture of lithium-ion batteries 	<ul style="list-style-type: none"> • Compact variant of standards-based cylinder DSNU • Quick and easy installation, even in tight spaces • Light weight • Self-adjusting pneumatic end-position cushioning saves time during commissioning and adapts optimally to load and speed changes • External piston rod thread • Magnetic piston for position sensing • Variants recommended for production facilities for the manufacture of lithium-ion batteries • Sustainable in production due to reduction of material use 	<ul style="list-style-type: none"> • ISO 6432 • Corrosion resistant against aggressive ambient conditions • Easy-to-clean design • Suitable for direct food contact according to European Regulation (EC) No. 1935/2004 • FDA-compliant seal and NSF-H1 lubrication • Wide range of variants for customized applications • Long service life thanks to optional dry-running seal • Self-adjusting pneumatic end-position cushioning saves time during commissioning and adapts optimally to load and speed changes • Magnetic piston for position sensing
online: →	dsnu	dsnu	dsnu	crdsnu

Product overview



Piston rod cylinders >

Round cylinders

	 Round cylinders CRDSNU, CRDSNU-B	 Round cylinder, NPT DSNU, ESNU	 Standards-based cylinder ESNU	 Round cylinders ESNU
Mode of operation	Double-acting	Double-acting, Single-acting	Pushing, Single-acting	Pushing, Single-acting
Piston diameter	32, 40, 50, 63, 80, 100	5/16, 3/8, 1/2, 5/8, 3/4, 1, 1.25, 1.625, 2, 2.5	8, 10, 12, 16, 20, 25	32, 40, 50, 63
Theoretical force at 0.6 MPa (6 bar, 87 psi), advance	483 ... 4712 N	24.821 ... 1763.008 N	19 ... 271 N	406 ... 1765 N
Stroke	1 ... 500 mm	10.16 ... 508 mm	1 ... 50 mm	1 ... 50 mm
Cushioning	Elastic cushioning rings/pads at both ends, Self-adjusting pneumatic end-position cushioning, Pneumatic cushioning, adjustable at both ends	Elastic cushioning rings/pads at both ends, Pneumatic cushioning, adjustable at both ends	Elastic cushioning rings/pads at both ends	Elastic cushioning rings/pads at both ends
Description	<ul style="list-style-type: none"> • Corrosion resistant against aggressive ambient conditions • Easy-to-clean design • Suitable for direct food contact according to European Regulation (EC) No. 1935/2004 • FDA-compliant seal and NSF-H1 lubrication • Wide range of variants for customized applications • Long service life thanks to optional dry-running seal • Self-adjusting pneumatic end-position cushioning saves time during commissioning and adapts optimally to load and speed changes • Magnetic piston for position sensing 	<ul style="list-style-type: none"> • Wide range of variants for customized applications • Good running performance and long service life • Piston rod with internal or external thread • Magnetic piston for position sensing 	<ul style="list-style-type: none"> • ISO 6432 • Wide range of variants for customized applications • Good running performance and long service life • Piston rod with internal or external thread • Magnetic piston for position sensing 	<ul style="list-style-type: none"> • Wide range of variants for customized applications • Good running performance and long service life • Piston rod with internal or external thread • Magnetic piston for position sensing
online: →	crdsnu	dsnu	esnu	esnu

Piston rod cylinders >





Round cylinders

	 Round cylinders CRHD	 Round cylinders EG-PK	 Round cylinder, NPT DPRA
Mode of operation	Double-acting	Pushing, Single-acting	Double-acting, Pushing, Single-acting, Pulling
Piston diameter	32, 40, 50, 63, 80, 100	2.5 mm, 4, 6	9/16", 3/4", 7/8", 1 1/16", 1 1/4", 1 1/2", 1 3/4", 2", 3/4, 1.25, 2, 2.5, 3
Theoretical force at 0.6 MPa (6 bar, 87 psi), advance	483 ... 4712 N	1.9 ... 11.8 N	
Stroke	10 ... 500 mm	5 ... 25 mm	1.5875 ... 304.8 mm
Cushioning	Pneumatic cushioning, adjustable at both ends	At one end, Not adjustable, No cushioning	No cushioning, Elastic cushioning rings/pads at both ends, Pneumatic cushioning, adjustable at both ends
Description	<ul style="list-style-type: none"> • Corrosion resistant against aggressive ambient conditions • Easy-to-clean design, optimized for very exacting demands • Flexible design thanks to different end caps • External piston rod thread • Magnetic piston for position sensing 	<ul style="list-style-type: none"> • Micro cylinder • Barbed fitting for plastic tubing with standard I.D. • Without position sensing 	<ul style="list-style-type: none"> • Direct exchange with common round inch cylinders • 10 bore sizes from 9/16" to 3" with a wide range of options for maximum flexibility • The stainless steel air cylinder made of 304 guarantees longevity and a long service life with constant running characteristics • Fits directly into existing designs, the simple replacement makes it the ideal choice for MRO
online: →	crhd	eg-pk	dpdra

Product overview



Piston rod cylinders >

Profile and tie rod cylinders

	 Standards-based cylinders DSBC	 Standards-based cylinders CRDNG, CRDNGS	 Standards-based cylinders, Clean Design DSBF	 Standards-based cylinders DSBG
Mode of operation	Double-acting	Double-acting	Double-acting	Double-acting
Piston diameter	32 mm, 40 mm, 50 mm, 63 mm, 80 mm, 100 mm, 125 mm	32 mm, 40 mm, 50 mm, 63 mm, 80 mm, 100 mm, 125 mm	32 mm, 40 mm, 50 mm, 63 mm, 80 mm, 100 mm, 125 mm	32 mm, 40 mm, 50 mm, 63 mm, 80 mm, 100 mm, 125 mm
Theoretical force at 0.6 MPa (6 bar, 87 psi), advance	415 ... 7363 N	483 ... 7363 N	415 ... 7363 N	415 ... 7363 N
Stroke	1 ... 2800 mm	10 ... 2000 mm	1 ... 2800 mm	1 ... 2800 mm
Cushioning	Elastic cushioning rings/pads at both ends, Self-adjusting pneumatic end-position cushioning, Pneumatic cushioning, adjustable at both ends	Pneumatic cushioning, adjustable at both ends	Elastic cushioning rings/pads at both ends, Self-adjusting pneumatic end-position cushioning, Pneumatic cushioning, adjustable at both ends	Elastic cushioning rings/pads at both ends, Self-adjusting pneumatic end-position cushioning, Pneumatic cushioning, adjustable at both ends
Description	<ul style="list-style-type: none"> • Self-adjusting pneumatic end-position cushioning saves time during commissioning and adapts optimally to load and speed changes • ISO 15552 (ISO 6431, VDMA 24562) • Sustainable thanks to extended life cycle due to simplified reparability • Standard profile with two sensor slots • Wide range of variants for customized applications • Comprehensive range of mounting accessories for just about every type of installation • Magnetic piston for position sensing • Variants recommended for production facilities for the manufacture of lithium-ion batteries 	<ul style="list-style-type: none"> • ISO 15552 (ISO 6431, VDMA 24562) • Corrosion resistant against aggressive ambient conditions • Easy-to-clean design • Variants: through piston rod, heat-resistant design • Nose mounting, mounting via accessories • Magnetic piston for position sensing 	<ul style="list-style-type: none"> • ISO 15552 • Increased corrosion protection • Easy-to-clean design • FDA-approved lubrication and sealing on the basic design • Long service life thanks to optional dry-running seal • Self-adjusting pneumatic end-position cushioning saves time during commissioning and adapts optimally to load and speed changes • Magnetic piston for position sensing • Sustainable thanks to extended life cycle due to simplified reparability 	<ul style="list-style-type: none"> • ISO 15552 (ISO 6431, VDMA 24562) • Sturdy tie rod design • Self-adjusting pneumatic end-position cushioning saves time during commissioning and adapts optimally to load and speed changes • Comprehensive range of mounting accessories for just about every type of installation • Magnetic piston for position sensing • Variants in accordance with EU Explosion Protection Directive (ATEX)
online: →	dsbc	crdng	dsbf	dsbg

Piston rod cylinders >





Profile and tie rod cylinders

	 Standards-based cylinders DSBG	 Standards-based cylinder, NPT DSNA	 Standards-based cylinder, NPT DSNB
Mode of operation	Double-acting	Double-acting	Double-acting
Piston diameter	160 mm, 200 mm, 250 mm, 320 mm	1 1/2", 3 1/4", 2 in, 2.5 in, 4 in	1 1/2", 3 1/4", 2 in, 2.5 in, 4 in, 5 in, 6 in
Theoretical force at 0.6 MPa (6 bar, 87 psi), advance	11310 ... 48255 N	170 ... 1059 N	680 ... 10888 N
Stroke	1 ... 2700 mm	6.35 ... 1219.2 mm	1.5875 ... 2513.0125 mm
Cushioning	Elastic cushioning rings/pads at both ends, Pneumatic cushioning, adjustable at both ends	Pneumatic cushioning, adjustable at both ends	Elastic cushioning rings/pads at both ends, Pneumatic cushioning, adjustable at both ends, No cushioning, Pneumatic cushioning at both ends, non-adjustable, Pneumatic cushioning at the front, non-adjustable, Pneumatic cushioning at the rear, non-adjustable, Pneumatic cushioning at the front, adjustable, Pneumatic cushioning at the rear, adjustable
Description	<ul style="list-style-type: none"> • ISO 15552 (ISO 6431, VDMA 24562) • Sturdy tie rod design • Pneumatic end-position cushioning adjustable at both ends • Optionally without end-position cushioning, adjustable at both ends, and position sensing, resulting in a price advantage • With optional spacer bolt attachment • Magnetic piston for position sensing • Variants in accordance with EU Explosion Protection Directive (ATEX) 	<ul style="list-style-type: none"> • 5 sizes from 1 1/2" to 4" for the common sizes • Complies with NFPA standard and allows easy replacement in existing machines, ideal for MRO • 303 stainless steel piston rod and tie-rods combined with anodized Al barrel and end caps give great durability and corrosion protection • FPM sealing option for additional chemical resistance and tough high temperature applications • Numerous NFPA mounting options offer maximum flexibility 	<ul style="list-style-type: none"> • 7 sizes from 1 1/2" to 6" • Complies with NFPA standard and allows easy replacement • Extensive range of options provides flexibility to meet your specific requirements • Extra long rod bearing made of a non-metallic composite material withstands heavy loads • Easy replacement of the bearing cartridge without dismantling the cylinder • Choice of end-position cushioning (elastomer, fixed pneumatic, adjustable pneumatic)
online: →	dsbg	dsna	dsnb

Product overview





Piston rod cylinders >

Compact, short-stroke and flat cylinders

	 Compact cylinder ADN-S	 Compact air cylinders AEN-S	 Compact cylinders ADN	 Compact cylinder, NPT ADN
Mode of operation	Double-acting	Pushing	Double-acting	Double-acting
Piston diameter	6 mm, 10 mm, 12 mm, 16 mm, 20 mm, 25 mm, 32 mm, 40 mm, 50 mm, 63 mm	6 mm, 10 mm, 12 mm, 16 mm, 20 mm, 25 mm, 32 mm, 40 mm, 50 mm, 63 mm	12 mm, 16 mm, 20 mm, 25 mm, 32 mm, 40 mm, 50 mm, 63 mm, 80 mm, 100 mm, 125 mm	1/2 in, 5/8 in, 3/4 in, 1 in, 1.25 in, 1.625 in, 2 in, 2.5 in
Theoretical force at 0.6 MPa (6 bar, 87 psi), advance	17 ... 1870 N	13 ... 1780 N	51 ... 7363 N	50.999 ... 1870.002 N
Stroke	5 ... 50 mm	5 ... 25 mm	1 ... 500 mm	0.9906 ... 399.9992 mm
Cushioning	Elastic cushioning rings/pads at both ends, No cushioning	Elastic cushioning rings/pads at both ends, No cushioning	Elastic cushioning rings/pads at both ends, Self-adjusting pneumatic end-position cushioning	Elastic cushioning rings/pads at both ends
Description	<ul style="list-style-type: none"> • Minimal fitting space • Extra light • Ideal for small movements • Piston rod with internal or external thread • Magnetic piston for position sensing • Variants recommended for production facilities for the manufacture of lithium-ion batteries • Sustainable in production due to reduction of material use 	<ul style="list-style-type: none"> • Minimal fitting space • Extra light • Ideal for small movements • High forces in a compact size • Piston rod with internal or external thread • Magnetic piston for position sensing 	<ul style="list-style-type: none"> • ISO 21287 • Up to 50% less installation space than comparable ISO cylinders to ISO 15552 • Good running performance and long service life • Wide range of variants for customized applications • Magnetic piston for position sensing • Variants recommended for production facilities for the manufacture of lithium-ion batteries • Sustainable thanks to extended life cycle due to simplified reparability 	<ul style="list-style-type: none"> • Piston rod with internal or external thread • Up to 50% less installation space than comparable ISO cylinders to ISO 15552 • Wide range of variants for customized applications • Magnetic piston for position sensing
online: →	adn-s	aen-s	adn	adn

Piston rod cylinders >



Compact, short-stroke and flat cylinders

	 Compact cylinders AEN	 Compact air cylinders, Multimount DPDM	 Compact cylinders ADN-EL	 Compact cylinders, Clean Design CDC
Mode of operation	Pushing, Single-acting, Pulling	Double-acting, Pushing, Single-acting, Pulling	Double-acting	Double-acting
Piston diameter	12 mm, 16 mm, 20 mm, 25 mm, 32 mm, 40 mm, 50 mm, 63 mm, 80 mm, 100 mm	6 mm, 10 mm, 16 mm, 20 mm, 25 mm, 32 mm	20 mm, 25 mm, 32 mm, 40 mm, 50 mm, 63 mm, 80 mm, 100 mm	20 mm, 25 mm, 32 mm, 40 mm, 50 mm, 63 mm, 80 mm
Theoretical force at 0.6 MPa (6 bar, 87 psi), advance	54 ... 4416 N	9 ... 483 N	188 ... 4712 N	141 ... 3016 N
Stroke	1 ... 25 mm	5 ... 50 mm	10 ... 500 mm	1 ... 500 mm
Cushioning	Elastic cushioning rings/pads at both ends	Elastic cushioning rings/pads at both ends	Elastic cushioning rings/pads at both ends	Elastic cushioning rings/pads at both ends
Description	<ul style="list-style-type: none"> • ISO 21287 • Up to 50% less installation space than comparable ISO cylinders to ISO 15552 • Good running performance and long service life • Wide range of variants for customized applications • Magnetic piston for position sensing 	<ul style="list-style-type: none"> • Mounting using through-hole and internal thread • Compact design • Piston rod variants • Magnetic piston for position sensing • Sustainable in production due to reduction of material use 	<ul style="list-style-type: none"> • ISO 21287 • With end-position locking at both ends, front or rear • Piston rod with internal or external thread • Magnetic piston for position sensing 	<ul style="list-style-type: none"> • ISO 21287 • Up to 50% less installation space than comparable ISO cylinders to ISO 15552 • Easy-to-clean design • Increased corrosion protection • Wide range of variants for customized applications • Piston rod with internal or external thread • Magnetic piston for position sensing
online: →	aen	dpdm	adn-el	cdc

Product overview



Piston rod cylinders >

Compact, short-stroke and flat cylinders

	 Flat cylinders DZF	 Flat cylinder, NPT DZF	 Flat cylinders DZH
Mode of operation	Double-acting	Double-acting	Double-acting
Piston diameter	Equivalent diameter, 12 mm, 18 mm, 25 mm, 32 mm, 40 mm, 50 mm, 63 mm	Equivalent diameter, 1/2 in, 11/16 in, 1 in, 1.25 in, 1.625 in, 2 in, 2.5 in	Equivalent diameter, 16 mm, 20 mm, 25 mm, 32 mm, 40 mm, 50 mm, 63 mm
Theoretical force at 0.6 MPa (6 bar, 87 psi), advance	51 ... 1870 N	68.058 ... 1870.033 N	104 ... 1870 N
Stroke	1 ... 320 mm	1.016 ... 330.2 mm	1 ... 1000 mm
Cushioning	Elastic cushioning rings/pads at both ends	Elastic cushioning rings/pads at both ends	Pneumatic cushioning, adjustable at both ends
Description	<ul style="list-style-type: none"> Extremely flat design Protected against rotation thanks to special piston shape Ideal for block assembly Wide variety of mounting and attachment options Piston rod with internal or external thread Magnetic piston for position sensing 	<ul style="list-style-type: none"> Extremely flat design Protected against rotation thanks to special piston shape Ideal for block assembly Wide variety of mounting and attachment options Piston rod with internal or external thread Magnetic piston for position sensing 	<ul style="list-style-type: none"> Flat design Protected against rotation thanks to special piston shape Ideal for block assembly Wide variety of mounting and attachment options External piston rod thread Magnetic piston for position sensing
online: →	dzf	dzf	dzh

Piston rod cylinders >



Compact, short-stroke and flat cylinders

	 Flat cylinders EZH	 Compact cylinder, NPT DPCHA	 Compact cylinder, NPT DPCHB
Mode of operation	Pushing, Single-acting	Double-acting, Pushing, Single-acting, Pulling	Double-acting, Pushing, Single-acting, Pulling
Piston diameter	Equivalent diameter, 3 mm, 6 mm, 12 mm, 22 mm	1 1/8", 1/2 in, 3/4 in, 1.625 in, 2 in, 2.5 in, 3 in, 4 in	1 1/16", 1 1/2", 1/2 in, 3/4 in, 2 in, 2.5 in, 3 in, 4 in
Theoretical force at 0.6 MPa (6 bar, 87 psi), advance	3.8 ... 205 N		
Stroke	10 ... 50 mm	1.5875 ... 101.6 mm	3.175 ... 101.6 mm
Cushioning	No cushioning	No cushioning, Elastic cushioning rings/ pads at both ends, Elastic cushioning rings/ plates, at front, Elastic cushioning rings/ plates, at rear	No cushioning, Elastic cushioning rings/ pads at both ends, Elastic cushioning rings/ plates, at front, Elastic cushioning rings/ plates, at rear
Description	<ul style="list-style-type: none"> Extremely flat design Protected against rotation thanks to special piston shape Wide variety of mounting and attachment options Magnetic piston for position sensing 	<ul style="list-style-type: none"> Single-part cylinder body and bushing holder for previously unattained rigidity and piston rod support. Machining of surfaces provides rectangularity and concentricity for positioning, assembly and mounting on the rod. Enables a dirt-free appearance for your machines. 8 sizes from 1/2" to 4", for high forces yet compact floorspace. Self-lubricating piston bushing and seals ensure a long service life and maintenance-free operation 	<ul style="list-style-type: none"> Dimensions enable direct integration into existing designs, ideal for MRO. Robust design with high-strength aluminum housing and end caps. Self-lubricating piston bushing and seals ensure a long service life and maintenance-free operation Stainless steel tie rods surrounded by aluminum alloy spacers ensure stability and rigidity. 8 sizes from 1/2" to 4", for high forces yet compact floorspace.
online: →	ezh	dpcha	dpchb

Product overview



Piston rod cylinders >

Multimount and cartridge cylinders

	 Compact air cylinders, Multimount DPDM	 Cartridge cylinders EGZ
Mode of operation	Double-acting, Pushing, Single-acting, Pulling	Pushing, Single-acting
Piston diameter	6 mm, 10 mm, 16 mm, 20 mm, 25 mm, 32 mm	6 mm, 10 mm, 16 mm
Theoretical force at 0.6 MPa (6 bar, 87 psi), advance	9 ... 483 N	13.9 ... 109 N
Stroke	5 ... 50 mm	5 ... 15 mm
Cushioning	Elastic cushioning rings/pads at both ends	No cushioning
Description	<ul style="list-style-type: none"> • Mounting using through-hole and internal thread • Compact design • Piston rod variants • Magnetic piston for position sensing • Sustainable in production due to reduction of material use 	<ul style="list-style-type: none"> • Minimal fitting space • Installation with or without mounting components • External piston rod thread
online: →	dpdm	egz



Piston rod cylinders >

Cylinders with clamping unit

	 Standards-based cylinder with clamping unit DSBC-C	 Round cylinder with clamping unit DSNU-KP	 Round cylinder with clamping unit DSNU-KP
Mode of operation	Double-acting	Double-acting	Double-acting
Piston diameter	32 mm, 40 mm, 50 mm, 63 mm, 80 mm, 100 mm, 125 mm	8 mm, 10 mm, 12 mm, 16 mm, 20 mm, 25 mm	32 mm, 40 mm, 50 mm, 63 mm
Theoretical force at 0.6 MPa (6 bar, 87 psi), advance	415 ... 7363 N	23 ... 295 N	483 ... 1870 N
Stroke	1 ... 2800 mm	1 ... 500 mm	1 ... 500 mm
Cushioning	Elastic cushioning rings/pads at both ends, Self-adjusting pneumatic end-position cushioning, Pneumatic cushioning, adjustable at both ends	Elastic cushioning rings/pads at both ends, Self-adjusting pneumatic end-position cushioning, Pneumatic cushioning, adjustable at both ends	Elastic cushioning rings/pads at both ends, Self-adjusting pneumatic end-position cushioning, Pneumatic cushioning, adjustable at both ends
Performance Level (PL)			
Description	<ul style="list-style-type: none"> • Piston rod can be held in any position • Piston rod can be held in position for long periods even with alternating loads, fluctuating operating pressure, or leaks in the system • Mounting hole pattern to ISO 15552 • Piston rod with internal or external thread • Magnetic piston for position sensing 	<ul style="list-style-type: none"> • Based on ISO 6432 • Piston rod can be held in any position • The piston rod can be held in position for long periods even with alternating loads, fluctuating operating pressure in the system, or loss of pressure • Magnetic piston for position sensing 	<ul style="list-style-type: none"> • Piston rod can be held in any position • The piston rod can be held in position for long periods even with alternating loads, fluctuating operating pressure in the system, or loss of pressure • Magnetic piston for position sensing
online: →	dsbc-c	dsnu-kp	dsnu-kp

Piston rod cylinders >





Cylinders with clamping unit

	 Compact cylinder with clamping unit ADN-KP	 Cylinder with holding brake DFCL	 Cylinder with holding brake DFLG
Mode of operation	Double-acting	Double-acting	Double-acting
Piston diameter	20 mm, 25 mm, 32 mm, 40 mm, 50 mm, 63 mm, 80 mm, 100 mm	40 mm, 63 mm, 100 mm	160 mm
Theoretical force at 0.6 MPa (6 bar, 87 psi), advance	188 ... 4712 N	754 ... 4712 N	12064 N
Stroke	10 ... 500 mm	10 ... 2000 mm	10 ... 2000 mm
Cushioning	Elastic cushioning rings/pads at both ends	Pneumatic cushioning, adjustable at both ends	Pneumatic cushioning, adjustable at both ends
Performance Level (PL)		Stopping, holding, blocking of movement/ Category 1, Performance Level c	Stopping, holding, blocking of movement/ Category 1, Performance Level c
Description	<ul style="list-style-type: none"> • Piston rod can be held in any position • The piston rod can be held in position for long periods even with alternating loads, fluctuating operating pressure in the system, or loss of pressure • Mounting hole pattern to ISO 21287 • Piston rod with internal or external thread • Magnetic piston for position sensing 	<ul style="list-style-type: none"> • Combination of holding brake and standards-based cylinder based on ISO 15552 • Holding function: the piston rod is retained by clamping with frictional locking • Emergency braking function: the movement of the piston rod is stopped by clamping with frictional locking • With safety functions • Variants in accordance with EU Explosion Protection Directive (ATEX) • Optional: high corrosion protection level • Magnetic piston for position sensing 	<ul style="list-style-type: none"> • Combination of holding brake and standards-based cylinder based on ISO 15552 • Holding function: the piston rod is retained by clamping with frictional locking • Emergency braking function: the movement of the piston rod is stopped by clamping with frictional locking • With safety functions • Variants in accordance with EU Explosion Protection Directive (ATEX) • Optional: high corrosion protection level • Magnetic piston for position sensing
online: →	adn-kp	dfcl	dflg

Product overview



Piston rod cylinders >

Stainless-steel cylinders

	 Standards-based cylinder CRDSNU, CRDSNU-B	 Round cylinders CRDSNU, CRDSNU-B	 Standards-based cylinders CRDNG, CRDNGS	 Round cylinders CRHD
Mode of operation	Double-acting	Double-acting	Double-acting	Double-acting
Piston diameter	12 mm, 16 mm, 20 mm, 25 mm	32 mm, 40 mm, 50 mm, 63 mm, 80 mm, 100 mm	32 mm, 40 mm, 50 mm, 63 mm, 80 mm, 100 mm, 125 mm	32 mm, 40 mm, 50 mm, 63 mm, 80 mm, 100 mm
Theoretical force at 0.6 MPa (6 bar, 87 psi), advance	68 ... 295 N	483 ... 4712 N	483 ... 7363 N	483 ... 4712 N
Stroke	1 ... 500 mm	1 ... 500 mm	10 ... 2000 mm	10 ... 500 mm
Cushioning	Elastic cushioning rings/pads at both ends, Self-adjusting pneumatic end-position cushioning, Pneumatic cushioning, adjustable at both ends	Elastic cushioning rings/pads at both ends, Self-adjusting pneumatic end-position cushioning, Pneumatic cushioning, adjustable at both ends	Pneumatic cushioning, adjustable at both ends	Pneumatic cushioning, adjustable at both ends
Description	<ul style="list-style-type: none"> • ISO 6432 • Corrosion resistant against aggressive ambient conditions • Easy-to-clean design • Suitable for direct food contact according to European Regulation (EC) No. 1935/2004 • FDA-compliant seal and NSF-H1 lubrication • Wide range of variants for customized applications • Long service life thanks to optional dry-running seal • Self-adjusting pneumatic end-position cushioning saves time during commissioning and adapts optimally to load and speed changes • Magnetic piston for position sensing 	<ul style="list-style-type: none"> • Corrosion resistant against aggressive ambient conditions • Easy-to-clean design • Suitable for direct food contact according to European Regulation (EC) No. 1935/2004 • FDA-compliant seal and NSF-H1 lubrication • Wide range of variants for customized applications • Long service life thanks to optional dry-running seal • Self-adjusting pneumatic end-position cushioning saves time during commissioning and adapts optimally to load and speed changes • Magnetic piston for position sensing 	<ul style="list-style-type: none"> • ISO 15552 (ISO 6431, VDMA 24562) • Corrosion resistant against aggressive ambient conditions • Easy-to-clean design • Variants: through piston rod, heat-resistant design • Nose mounting, mounting via accessories • Magnetic piston for position sensing 	<ul style="list-style-type: none"> • Corrosion resistant against aggressive ambient conditions • Easy-to-clean design, optimized for very exacting demands • Flexible design thanks to different end caps • External piston rod thread • Magnetic piston for position sensing
online: →	crdsnu	crdsnu	crdng	crhd

Rodless cylinders >



Mechanically coupled cylinders

	 Linear actuators DLGF	 Linear actuators DGC-K	 Linear actuators DGC-G, DGC-GF, DGC-KF
Mode of operation	Double-acting	Double-acting	Double-acting
Piston diameter	20 mm, 25 mm, 32 mm, 40 mm	18 mm, 25 mm, 32 mm, 40 mm, 50 mm, 63 mm, 80 mm	8 mm, 12 mm, 18 mm, 25 mm, 32 mm, 40 mm, 50 mm, 63 mm
Theoretical force at 0.6 MPa (6 bar, 87 psi), advance	188 ... 754 N	153 ... 3016 N	30 ... 1870 N
Stroke	50 ... 1000 mm	1 ... 8500 mm	1 ... 8500 mm
Cushioning	Self-adjusting pneumatic end-position cushioning	Pneumatic cushioning, adjustable at both ends	Elastic cushioning rings/pads at both ends, Pneumatic cushioning, adjustable at both ends, Pneumatic shock absorber, hard characteristic curve, Pneumatic shock absorber, soft characteristic curve
Position sensing	For proximity sensor	For proximity sensor	For proximity sensor
Description	<ul style="list-style-type: none"> Extremely flat design Choice of two damping types: Self-adjusting pneumatic end-position cushioning or external hydraulic shock absorbers Supply port at the left or right end or at both ends or alternatively from below Loads and machining jigs can be directly mounted on the slide Basic design DLGF-G without external guide for simple actuator functions in small installation spaces Recirculating ball bearing guide DLGF-KF with a standard recirculating ball bearing guide for high torques and heavy loads Sustainable thanks to extended life cycle due to simplified reparability 	<ul style="list-style-type: none"> Compact design: 30% smaller than the basic design DGC-G Basic actuator without guide, for simple actuator functions Low moving dead weight Symmetrical design 	<ul style="list-style-type: none"> All settings accessible from one side With optional variable end stops and intermediate position module Sustainable thanks to extended life cycle due to simplified reparability Optional: NSF-H1 lubricant for the food zone (see www.festo.com/certificates/DGC) Optional: clamping unit for holding loads Sustainable in operation due to leakage reduction at sealing points
online: →	dlgf	dgc-k	dgc

Product overview



Rodless cylinders >

Mechanically coupled cylinders

	 Linear actuators with heavy-duty guide DGC-HD	 Linear actuators SLG
Mode of operation	Double-acting	Double-acting
Piston diameter	18 mm, 25 mm, 40 mm	8 mm, 12 mm, 18 mm
Theoretical force at 0.6 MPa (6 bar, 87 psi), advance	153 ... 754 N	30 ... 153 N
Stroke	1 ... 5000 mm	100 ... 900 mm
Cushioning	Pneumatic shock absorber, hard characteristic curve, Pneumatic shock absorber, soft characteristic curve	Elastic cushioning rings/pads at both ends, Pneumatic shock absorber, hard characteristic curve
Position sensing	For proximity sensor	For proximity sensor
Description	<ul style="list-style-type: none"> • For maximum loads and torques thanks to duo rail guide • Very good operating behavior under torque load • Long service life • Ideal as a basic axis for linear gantries and cantilever axes • Wide range of options for mounting on actuator units 	<ul style="list-style-type: none"> • Extremely flat design • Highest precision thanks to integrated ball bearing guide • Adjustable end stops • Wide range of supply ports • Available with intermediate position module
online: →	dgc-hd	slg

Rodless cylinders >

Magnetically coupled cylinders

	 Linear actuators DGO	 Linear actuators, NPT DGO	 Linear actuator units SLM
Mode of operation	Double-acting	Double-acting	Double-acting
Piston diameter	12 mm, 16 mm, 20 mm, 25 mm, 32 mm, 40 mm	1/2 in, 5/8 in, 3/4 in, 1 in, 1.25 in, 1.625 in	12 mm, 16 mm, 20 mm, 25 mm, 32 mm, 40 mm
Theoretical force at 0.6 MPa (6 bar, 87 psi), advance	68 ... 754 N	68 N	68 ... 754 N
Stroke	10 ... 4000 mm	1.016 ... 3987.8 mm	10 ... 1500 mm
Cushioning	Elastic cushioning rings/pads at both ends, Pneumatic cushioning, adjustable at both ends	Elastic cushioning rings/pads at both ends, Pneumatic cushioning, adjustable at both ends	Elastic cushioning rings/pads at both ends, Pneumatic shock absorber, hard characteristic curve
Position sensing	For proximity sensor		For proximity sensor, For inductive proximity sensors
Description	<ul style="list-style-type: none"> • Magnetic power transmission • Pressure-tight and zero leakage • Dirt-proof and dust-proof • Sustainable in operation due to leakage reduction at sealing points 	<ul style="list-style-type: none"> • Magnetic power transmission • Pressure-tight and zero leakage • Dirt-proof and dust-proof 	<ul style="list-style-type: none"> • Magnetic power transmission • Ball bearing guide: combination of slide unit and rodless linear actuator • Individual choice of end-position cushioning and sensing
online: →	dgo	dgo	slm

Software tools

Mass moment of inertia





Juggling pencils and pocket calculators is now a thing of the past. No matter whether you have disks, blocks, push-on flanges, grippers, etc., this tool does the job of calculating all the mass moments of inertia. Just save, send, or print and you're finished.

This tool can be found at
[→ www.festo.com/x/mass-moment-of-inertia](http://www.festo.com/x/mass-moment-of-inertia)

Rotary actuators >



Vane actuators

	 Quarter turn actuators DRVS	 Quarter turn actuators DSM	 Quarter turn actuators DSM-B, DSM-HD-B
Size	6, 8, 12, 16, 25, 32, 40	6, 8, 10	12, 16, 25, 32, 40, 63
Theoretical torque at 0.6 MPa (6 bar, 87 psi)	0.15 ... 20 Nm	0.15 ... 1.7 Nm	1.25 ... 80 Nm
Permissible mass moment of inertia	6.5 ... 350 kgcm ²	6.5 ... 26 kgcm ²	50 ... 5000 kgcm ²
Position sensing	For proximity sensor	For proximity sensor, None	For proximity sensor, None
Swivel angle	0 ... 270 deg	0 ... 240 deg	0 ... 270 deg
Description	<ul style="list-style-type: none"> • Double-acting rotary vane actuator • Lighter than other quarter turn actuators • Fixed swivel angle, adjustable swivel angle possible with the help of accessories • Housing protected against splash water and dust • Sustainable in production due to reduction of material use 	<ul style="list-style-type: none"> • Double-acting rotary vane actuator or with tandem rotary vanes • Fixed or infinitely adjustable swivel angle • With spigot or hollow flanged shaft • With elastic cushioning rings/plates at both ends 	<ul style="list-style-type: none"> • Double-acting rotary vane actuator, with tandem rotary vanes or heavy-duty bearing • Swivel angle is infinitely adjustable over the entire swivel range • With elastic cushioning rings/plates at both ends, adjustable or with pneumatic shock absorbers at both ends, self-adjusting
online: →	drvs	dsm	dsm

Product overview

Rotary actuators >

Quarter turn actuators with rack and pinion

	 Quarter turn actuators DRRS	 Quarter turn actuators DRRD
Size	12, 16, 20, 25	8, 10, 12, 16, 20, 25, 32, 35, 40, 50, 63
Theoretical torque at 0.6 MPa (6 bar, 87 psi)	0.9 ... 6.6 Nm	0.2 ... 112 Nm
Permissible mass moment of inertia	50 ... 600 kgcm ²	15 ... 420000 kgcm ²
Position sensing	For proximity sensor	For proximity sensor
Swivel angle	180 deg	180 deg
Description	<ul style="list-style-type: none"> • Twin-piston rotary actuator, power transmission via rack and pinion principle • Attractively priced semi-rotary drive for standard energy consumption (load capacity + speed) • For torque requirements up to 33 Nm at 0.6 MPa • Recommended for production plants for manufacturing lithium-ion batteries, F1A • Sustainable in production due to reduction of material use 	<ul style="list-style-type: none"> • Twin-piston rotary actuator, power transmission via rack and pinion principle • Premium drive for very high energy absorption (load capacity and speed) • Very high precision and long service life • Many additional features such as center position or air and energy through-feed can be adapted • Sustainable thanks to extended life cycle due to simplified reparability • Sustainable in production due to reduction of material use
online: →	drrs	drrd



Rotary actuators >

Swivel linear actuators

	 Swivel/linear actuator units DSL-B
Piston diameter	16 mm, 20 mm, 25 mm, 32 mm, 40 mm
Theoretical torque at 0.6 MPa (6 bar, 87 psi)	1.25 ... 20 Nm
Permissible mass moment of inertia	0.35 ... 40 kgcm ²
Position sensing	For proximity sensor
Swivel angle	0 ... 272 deg
Description	<ul style="list-style-type: none"> • Rotary and linear motion can be controlled individually or simultaneously • High repeatability • With plain or ball bearing guide • Through piston rod
online: →	dsl

Pneumatic special cylinders >

Tandem and high-force cylinders

	 High-force cylinders ADNH	 Tandem cylinders DNCT
Mode of operation	Double-acting	Double-acting
Piston diameter	25 mm, 40 mm, 63 mm, 100 mm	32 mm, 40 mm, 50 mm, 63 mm, 80 mm, 100 mm, 125 mm
Stroke	5 ... 150 mm	2 ... 500 mm
Theoretical force at 0.6 MPa (6 bar, 87 psi), advance	1036 ... 18281 N	898 ... 14244 N
Cushioning	Elastic cushioning rings/pads at both ends	Pneumatic cushioning, adjustable at both ends
Description	<ul style="list-style-type: none"> • Max. 4 cylinders can be combined • Increased thrust force • Only 2 connections are required to pressurize all cylinders • Piston rod with internal or external thread • Magnetic piston for position sensing • Mounting hole pattern to ISO 21287 	<ul style="list-style-type: none"> • Max. 2 cylinders can be combined • Thrust and return force increase • External piston rod thread • Magnetic piston for position sensing • Mounting hole pattern to ISO 15552
online: →	adnh	dnct

Pneumatic special cylinders >



Multi-position cylinders

	 Multi-position cylinders ADNMM
Piston diameter	25 mm, 40 mm, 63 mm, 100 mm
Possible stroke of intermediate positions	1 ... 400 mm
Possible stroke of last cylinder position	1 ... 2000 mm
Theoretical force at 0.6 MPa (6 bar, 87 psi), advance	295 ... 4712 N
Max. total of all individual strokes	1000 mm, 2000 mm
Description	<ul style="list-style-type: none"> • Mounting hole pattern to ISO 21287 • Piston rod with internal or external thread • 2 ... 5 cylinders can be combined • Max. 5 positions can be approached • Magnetic piston for position sensing
online: →	adnm

Product overview



Guided cylinders >

Linear slides

	 Mini slide DGSS	 Mini slide DGST	 Mini slides DGSL
Piston diameter	6 mm, 10 mm, 16 mm, 20 mm	6 mm, 8 mm, 10 mm, 12 mm, 16 mm, 20 mm, 25 mm	6 mm, 8 mm, 10 mm, 12 mm, 16 mm, 20 mm, 25 mm, 32 mm
Theoretical force at 0.6 MPa (6 bar, 87 psi), advance	17 ... 188 N	34 ... 589 N	17 ... 483 N
Stroke	5 ... 60 mm	10 ... 200 mm	10 ... 200 mm
Cushioning	Elastomer cushioning, at both ends, stroke not adjustable	Short elastic cushioning rings/pads at both ends, Elastomer cushioning, at both ends, stroke not adjustable, Elastic cushioning rings/pads at both ends, Elastic cushioning rings/pads at both ends with fixed stop, External hydraulic cushioning	Short elastic cushioning rings/pads at both ends, No cushioning, Elastic cushioning rings/pads at both ends, Elastic cushioning rings/pads at both ends with fixed stop, Self-adjusting pneumatic shock absorber, progressive at both ends, with reducing sleeve, Progressive pneumatic shock absorbers at both ends
Position sensing	For proximity sensor	For proximity sensor	For proximity sensor
Description	<ul style="list-style-type: none"> • Flat design • High positioning accuracy • Precise and loadable rolling bearing guide • Optimum price/performance ratio • Slide and retaining plate from one component • Operation possible without additional cushioning elements • Optional: stroke adjustment and external cushioning via accessories • Recommended for production systems for the manufacture of Li-ion batteries (F1A) 	<ul style="list-style-type: none"> • Powerful twin-piston actuator • Shortest mini slide on the market • Precise recirculating ball bearing guide • Versatile mounting options • Design with supply ports and sensor slots that have a mirror-inverted configuration for space-saving installation can be ordered via the configurator • Variants recommended for production facilities for the manufacture of lithium-ion batteries • Sustainable in production due to reduction of material use 	<ul style="list-style-type: none"> • High load capacity and positioning accuracy • Maximum movement precision thanks to ground-in ball bearing cage guide • Maximum flexibility thanks to 8 sizes and a large selection of damping variants • Variants with clamping unit or end-position locking for fixing the guide carriage • Wide variety of mounting and attachment options • Compact design
online: →	dgss	dgst	dgsl

Guided cylinders >





Linear slides

	 Mini slides DGSC	 Mini slides SLF	 Mini slides SLS
Piston diameter	6 mm	6 mm, 10 mm, 16 mm	6 mm, 10 mm, 16 mm
Theoretical force at 0.6 MPa (6 bar, 87 psi), advance	17 N	17 ... 121 N	17 ... 121 N
Stroke	10 mm	10 ... 80 mm	5 ... 30 mm
Cushioning	Elastic cushioning rings/pads at both ends	Elastic cushioning rings/pads at both ends	Elastic cushioning rings/pads at both ends
Position sensing	None	For proximity sensor	For proximity sensor
Description	<ul style="list-style-type: none"> • Smallest guided slide unit on the market • Precision ball bearing cage guide: reliable and high-quality process • Long service life thanks to housing made from high-alloy steel • Low break-away pressure and uniform movement thanks to minimal friction of guide and seal 	<ul style="list-style-type: none"> • Flat design • Ball bearing cage guide • Versatile mounting options • Easy adjustment of end positions 	<ul style="list-style-type: none"> • Flat design • Ball bearing cage guide • Versatile mounting options
online: →	dgsc	slf	sls

Product overview





01 Guided cylinders >

Drives with guide rods

	 Guided drive DGRC	 Twin cylinder DGTZ	 Guided drives DFM, DFM-B	 Guided drives DGRF
Piston diameter	12 mm, 16 mm, 20 mm, 25 mm, 32 mm, 40 mm, 50 mm	6 mm, 10 mm, 16 mm, 20 mm, 25 mm, 32 mm	6 mm, 10 mm, 12 mm, 16 mm, 20 mm, 25 mm, 32 mm, 40 mm, 50 mm, 63 mm, 80 mm, 100 mm	20 mm, 25 mm, 32 mm, 40 mm, 50 mm, 63 mm
Theoretical force at 0.6 MPa (6 bar, 87 psi), advance	68 ... 1178 N	18.6 ... 966 N	17 ... 4712 N	189 ... 1870 N
Stroke	5 ... 100 mm	10 ... 200 mm	5 ... 400 mm	10 ... 400 mm
Cushioning	Elastic cushioning rings/pads at both ends	Elastic cushioning rings/pads at both ends	Elastic cushioning rings/pads at both ends, Pneumatic cushioning, adjustable at both ends, Pneumatic shock absorber, soft characteristic curve	Elastic cushioning rings/pads at both ends, Self-adjusting pneumatic end-position cushioning, Pneumatic cushioning, adjustable at both ends
Position sensing	For proximity sensor	For proximity sensor	For proximity sensor	For proximity sensor
Description	<ul style="list-style-type: none"> Minimal product weight and reduced installation space Drive and guide unit in a single housing Recommended for production plants for manufacturing lithium-ion batteries, F1A Food grade lubrication High resistance to torques and lateral forces Variable stroke 	<ul style="list-style-type: none"> Minimal space requirement Minimal mounting time High resistance to torques and lateral forces High rigidity thanks to its guide rods with large diameter and two plain-bearing bushes Wide range of mounting options Actuator and guide unit in a single housing Plain bearing 	<ul style="list-style-type: none"> Actuator and guide unit in a single housing High resistance to torques and lateral forces Plain or ball bearing guide Wide variety of mounting and attachment options Wide range of variants for customized applications Variants recommended for production facilities for the manufacture of lithium-ion batteries 	<ul style="list-style-type: none"> Easy-to-clean design Increased corrosion protection FDA-approved lubrication and sealing on the basic design Hygienic mounting of the sensors possible Compact design with high guide precision and load capacity Long service life thanks to optional dry-running seal Self-adjusting pneumatic end-position cushioning saves time during commissioning and adapts optimally to load and speed changes
online: →	dgrc	dgtz	dfm	dgrf

Guided cylinders >



Drives with guide rods

	 Compact cylinders ADNGF	 Mini guided drives DFC	 Twin cylinder DPZ	 Twin cylinder DPZJ
Piston diameter	12 mm, 16 mm, 20 mm, 25 mm, 32 mm, 40 mm, 50 mm, 63 mm, 80 mm, 100 mm	6 mm, 10 mm	10 mm, 16 mm, 20 mm, 25 mm, 32 mm	10 mm, 16 mm, 20 mm, 25 mm, 32 mm
Theoretical force at 0.6 MPa (6 bar, 87 psi), advance	68 ... 4712 N	17 ... 47 N	60 ... 966 N	60 ... 724 N
Stroke	1 ... 400 mm	5 ... 30 mm	10 ... 100 mm	10 ... 100 mm
Cushioning	Elastic cushioning rings/pads at both ends, Self-adjusting pneumatic end-position cushioning	Elastic cushioning rings/pads at both ends	Elastic cushioning rings/pads at both ends	Elastic cushioning rings/pads at both ends
Position sensing	For proximity sensor	For proximity sensor	For proximity sensor	For proximity sensor
Description	<ul style="list-style-type: none"> • ISO 21287 • Piston rod secured against rotation by a guide rod and yoke plate • Plain bearing • Available with through piston rod • Higher load capacity thanks to guide rod and yoke plate • Magnetic piston for position sensing 	<ul style="list-style-type: none"> • Smallest guided drive • High precision and load capacity • Minimal space requirement • Actuator and guide unit in a single housing • Plain or ball bearing guide • Sustainable thanks to extended life cycle due to simplified reparability 	<ul style="list-style-type: none"> • Twin pistons provide twice the force in half the space • Plain or ball bearing guide • Precision stroke adjustment in the end position 	<ul style="list-style-type: none"> • With yoke plate on rear of cylinder for higher lateral forces and precision • Twin pistons provide twice the force in half the space • Plain or ball bearing guide • Precision stroke adjustment in the end position
online: →	adngf	dfc	dpz	dpzj

Product overview

01 Stopper cylinders and feed separators >

Stopper cylinders

	 Stopper cylinders DFSP	 Stopper cylinders DFST-G2	 Stopper cylinders STAF
Piston diameter	16 mm, 20 mm, 32 mm, 40 mm, 50 mm	32 mm, 50 mm, 63 mm, 80 mm	80 mm
Permissible impact force on the advanced piston rod	710 ... 6280 N	1000 ... 6000 N	13300 ... 14600 N
Stroke	5 ... 30 mm	20 ... 40 mm	30 ... 40 mm
Position sensing	For proximity sensor	For proximity sensor	For proximity sensor
Toggle lever position query		For inductive proximity sensors	
Description	<ul style="list-style-type: none"> • Trunnion version with/without internal thread, with/without protection against rotation • Roller version with protection against rotation • Compact design • Sensor slots on 3 sides • Long service life thanks to very good cushioning characteristics and sturdy piston rod guide • Safe stopping of workpiece carriers, pallets, and packages weighing up to 90 kg 	<ul style="list-style-type: none"> • Toggle lever design • Built-in, adjustable pneumatic shock absorber for smooth and adapted stopping • Up to 800 kg impact load • For position sensing on the piston • Adjustable active direction thanks to rotatable toggle lever arrangement (90°, 180°, 270°) • Lever locking mechanism • Toggle lever deactivator • Roller version made from polyamide or steel 	<ul style="list-style-type: none"> • Roller version • Absorption of high lateral forces • Direct mounting of solenoid valves on flange plate
online: →	dfsp	dfst	staf

Software tools

Feed separator selection
program

This tool helps you select the right type HPV feed separator from Festo for your application.



Let the program guide you – enter the general parameters, and you will receive an evaluation with at least one suggestion for the product that is best suited to your application.

This tool can be found at

→ www.festo.com/x/feed-separator-selection-tool

Stopper cylinders and feed separators >

Feed separators

	 Feed separators HPVS	 Feed separators HPV
Mode of operation	Double-acting	Double-acting
Piston diameter	10 mm, 14 mm, 22 mm	10 mm, 14 mm, 22 mm
Stroke	10 ... 60 mm	10 ... 60 mm
Theoretical force at 0.6 MPa (6 bar, 87 psi), advance	45 ... 225 N	45 ... 225 N
Description	<ul style="list-style-type: none"> • Version with one plunger • With non-rotating piston rod • Proximity sensor SME/SMT-8 can be integrated in the housing 	<ul style="list-style-type: none"> • Version with two plungers • With twin piston, non-rotating piston rod, and locking mechanism • Cost-effective: replaces at least two actuators in the feed process • Proximity sensor SME/SMT-8 can be integrated in the housing
online: →	hpvs	hvp

Clamp cylinders >

Clamping modules

	 Clamping modules EV
Clamping area	10x30, 15x40, 15x63, 20x75, 20x120, 20x180, Ø16 mm, Ø20 mm, Ø25 mm, Ø32 mm, Ø40 mm, Ø50 mm, Ø63 mm, Ø12 mm
Stroke	3 ... 5 mm
Description	<ul style="list-style-type: none"> • Compact rodless cylinder with diaphragm • Single-acting, with reset function • Flat design • Hermetically sealed • Pressure plates and foot mounting as accessories
online: →	ev

Product overview

Clamp cylinders >

Linear/swivel clamps



Swing clamp cylinders
CLR

Piston diameter	12 mm, 16 mm, 20 mm, 25 mm, 32 mm, 40 mm, 50 mm, 63 mm
Theoretical clamping force at 0.6 MPa (6 bar, 87 psi)	51 ... 1682 N
Clamping stroke	10 ... 50 mm
Swivel angle	90° +/- 2°, 90° +/- 3°, 90° +/- 4°
Description	<ul style="list-style-type: none"> • Swiveling and clamping in one step • Adjustable swivel direction • Clamping fingers as accessories • With optional dust and welding spatter protection • Double-acting • Magnetic piston for position sensing
online: →	clr

Clamp cylinders >

Hinge cylinders



Hinge cylinders
DWA, DWB, DWC

Piston diameter	50 mm, 63 mm, 80 mm
Stroke	10 ... 200 mm
Theoretical force at 0.6 MPa (6 bar, 87 psi), advance	1178 ... 3016 N
Position sensing	For proximity sensor, None
Cushioning	Pneumatic cushioning, adjustable at both ends
Description	<ul style="list-style-type: none"> • For clamping of components during the welding process • Double-acting • Easy to mount thanks to the swivel bearing on the bearing cap • Integrated throttling • Integrated end-position cushioning • Rod wiper seal to protect against welding spatter • Asian automotive standard for car body production
online: →	dw

Diaphragm actuators & air spring systems >

Bellows actuators



Bellow cylinder
EB

Size	80, 145, 165, 215, 250, 325, 385
Stroke	20 ... 230 mm
Description	<ul style="list-style-type: none"> • Use as a spring element or for reducing oscillations • Single- or double-bellows cylinder • High forces with a short stroke • Friction-free movement: no stick-slip effect • Use in dusty environments or in water • Maintenance-free
online: →	eb

Diaphragm actuators & air spring systems >

Fluidic muscles



Fluidic muscles
DMSP

Size	5, 10, 20, 40
Theoretical force at 0.6 MPa (6 bar, 87 psi)	140 ... 6000 N
Nominal length	30 ... 9000 mm
Max. contraction	20% of nominal length, 25% of the nominal length
Description	<ul style="list-style-type: none"> • Single-acting, pulling • 10 times the initial force of a comparable pneumatic cylinder • Friction-free movement: no stick-slip effect • Hermetically sealed design offers protection against dust, dirt, and fluids • Outstanding strength-to-weight ratio
online: →	dmsp

Product overview

01 Software tools

Pneumatic cylinders

Rotary indexing table selection



This tool helps you to select the right type DHTG rotary indexing table from Festo for your application. Let the program guide you – enter the general parameters, and you will receive an evaluation with at least one suggestion for the product that is best suited to your application.

This tool can be found at
[→ www.festo.com/x/rotary-indexing-table-selection](http://www.festo.com/x/rotary-indexing-table-selection)

[Rotary indexing tables >](#)

Rotary indexing tables



**Rotary indexing tables
DHTG**

Size	65, 90, 140, 220
Theoretical torque at 0.6 MPa (6 bar, 87 psi)	2.1 ... 58.9 Nm
Cushioning	Pneumatic shock absorber, hard characteristic curve, adjustable
Position sensing	For inductive proximity sensors
Spacing	2 ... 24
Description	<ul style="list-style-type: none"> • For swiveling or separating tasks • Sturdy mechanical system • Easy planning and commissioning • Rotary table diameters: 65, 90, 140, 220 mm • Free control of rotational direction • Sustainable thanks to extended life cycle due to simplified repairability
online: →	dhtg

Software tools

Shock absorber selection







Whether diagonal or vertical, curved or straight, lever or disc, all cases of damped movements are taken into account. The tool always suggests the best shock absorber.

This tool can be found at



→ www.festo.com/x/shock-absorber-selection-tool

Industrial shock absorber



	 Shock absorber DYSD	 Shock absorbers DYSS	 Shock absorbers DYSR	 Shock absorbers YSR-C
Size	4, 5, 7, 8, 12, 16, 20, 25, 32	2, 3, 4, 5, 7, 8, 10, 12	8, 12, 16, 20, 25, 32	4, 5, 7, 8, 10, 12, 16, 20, 25, 32
Stroke	4 ... 25 mm	4 ... 12 mm	8 ... 60 mm	4 ... 60 mm
Max. energy absorption per stroke	0.6 ... 270 J	0.1 ... 10 J	4 ... 384 J	0.6 ... 380 J
Cushioning	Self-adjusting	Self-adjusting	Adjustable	Self-adjusting
Description	<ul style="list-style-type: none"> Hydraulic shock absorber with path-controlled throttle function Especially for applications in the pressure chamber Short cushioning stroke Suitable for rotary actuators Maintenance-free Rapidly increasing cushioning force curve Through fastening thread With fixed stop on housing and hexagon socket for stroke adjustment With additional return spring for compensation in the pressure chamber 	<ul style="list-style-type: none"> Hydraulic shock absorber with path-controlled throttle function Rapidly increasing cushioning force curve Short cushioning stroke Suitable for low-vibration operation Variants recommended for production facilities for the manufacture of lithium-ion batteries 	<ul style="list-style-type: none"> Hydraulic shock absorber with spring return Adjustable cushioning hardness 	<ul style="list-style-type: none"> Hydraulic shock absorber with path-controlled throttle function Rapidly increasing cushioning force curve Short cushioning stroke Suitable for rotary actuators
online: →	dyss	dyss	dysr	ysr-c

Product overview

Industrial shock absorber





	 Shock absorbers YSRW	 Shock absorbers YSRW-DGC	 Shock absorbers DYEF-Y1, DYEF-Y1F
Size	5, 7, 8, 10, 12, 16, 20	8, 12, 18, 25, 32, 40, 50, 63	M10, M12, M14, M16, M22, M4, M5, M6, M8
Stroke	8 ... 34 mm		0.9 ... 7 mm
Max. energy absorption per stroke	1.3 ... 70 J		0.005 ... 1.2 J
Cushioning	Self-adjusting, Soft characteristic curve	Self-adjusting, Soft characteristic curve	Elastic cushioning rings/pads at both ends with metallic fixed stop, Elastic cushioning rings/pads at both ends, without fixed metal stop
Description	<ul style="list-style-type: none"> Hydraulic shock absorber with path-controlled throttle function Gently increasing cushioning force curve Long cushioning stroke Suitable for low-vibration operation Short cycle times possible 	<ul style="list-style-type: none"> For linear actuators DGC Gently increasing cushioning force curve 	<ul style="list-style-type: none"> Mechanical shock absorber with flexible rubber buffer Flexible rubber buffer allows a defined metal end position Adjustable cushioning hardness Ideal for cushioning low energy With precise metal end position Variants recommended for production facilities for the manufacture of lithium-ion batteries
online: →	ysrw	ysrw-dgc	dyef

Industrial shock absorber

	 Shock absorbers DYSC	 Shock absorbers DYSW	 Hydraulic cushioning cylinders DYHR
Size	4, 5, 7, 8, 12, 16, 20, 25	4, 5, 7, 8, 10, 12	16, 20, 25, 32
Stroke	4 ... 25 mm	6 ... 20 mm	20 ... 60 mm
Max. energy absorption per stroke	0.6 ... 100 J	0.8 ... 12 J	32 ... 384 J
Cushioning	Self-adjusting	Self-adjusting, Soft characteristic curve	Adjustable
Description	<ul style="list-style-type: none"> Hydraulic shock absorber with path-controlled throttle function Rapidly increasing cushioning force curve Short cushioning stroke Suitable for rotary actuators With metal fixed stop 	<ul style="list-style-type: none"> Hydraulic shock absorber with path-controlled throttle function Gently increasing cushioning force curve Long cushioning stroke Suitable for low-vibration operation Short cycle times possible With metal fixed stop 	<ul style="list-style-type: none"> Hydraulic cushioning cylinder for constant, slow braking speeds across the entire stroke Braking speed can be precisely adjusted Built-in compression spring returns the piston rod to the initial position Suitable for slow feed speeds in the range up to 0.1 m/s
online: →	dysc	dysw	dyhr

Cylinder mounting parts and accessories

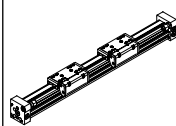



Accessories for pneumatic drives

	 Mounting attachments	 Piston-rod attachments	 Electric linear axes DGC-FA	 Guide units FEN, FENG
Size	6, 8, 12, 16, 18, 20, 25, 30, 32, 40, 50, 63, 80, 100, 125, 160, 200, 250, 320, 1 1/16", 1 1/2", 1 3/4", 100/125, 12/16, 12/18, 160/200, 18/25, 20/25, 25/32, 32/40, 40/50, 50/63, 63/80, 8/10, 8/12, AA 1 to VDI/VDE 3845, AA 2 to VDI/VDE 3845, AA 3 to VDI/VDE 3845, 1.25 in, 1.625 in, 1 in, 1/2 in, 11/16 in, 2.5 in, 2 in, 3/4 in, 4 in, M10x1, M18x1.5, M22x1.5, M30x1.5, M8	6, 8, 10, 12, 16, 20, 25, 32, 35, 40, 50, 63, 1-12 UNF-2B, 1/2-20 UNF-2A, 1/2-20 UNF-2B, 1/4-28 UNF-2B, 10-32 UNF-2A, 10-32 UNF-2B, 10x30, 15x40, 15x63, 20/25, 20x120, 20x180, 20x75, 3/4-16 UNF-2A, 3/4-16 UNF-2B, 3/8-24 UNF-2A, 3/8-24 UNF-2B, 32/40, 5/16-24 UNF-2A, 5/16-24 UNF-2B, 5/8-18 UNF-2A, 5/8-18 UNF-2B, 50/63, 6-32 UNF-2B, 7/16-20 UNF-2B, 8-32 UNC-2A, M10, M10x1.25, M12, M12x1.25, M16, M16x1.5, M20x1.5, M27x2, M36x2, M4, M42x2, M48x2, M5, M6, M8	1 ... 8500 mm	1 ... 500 mm
Stroke				
Description	<ul style="list-style-type: none"> • Mounting kits • Direct mountings • Foot mountings • Flange mountings • Swivel mountings • Clevis feet, trunnion supports • Multi-position kits • Slot nuts • Centering pins/sleeves 	<ul style="list-style-type: none"> • Rod clevises • Rod eyes • Coupling pieces • Self-aligning rod couplers • Adapter 	<ul style="list-style-type: none"> • Without actuator • With ball bearing guide • With guide and freely movable slide unit • High torsional resistance • Reduced vibrations with dynamic loads • For supporting forces and torques in multi-axis applications 	<ul style="list-style-type: none"> • For protecting ISO cylinders against rotation at high torque loads • Plain or ball bearing guide • High guide precision for workpiece handling
online: →	n_015001	n_03150	dgc-fa	fen

Product overview

Cylinder mounting parts and accessories

Accessories for pneumatic drives

	 Clamping cartridges KP	 Clamping units KPE	 Clamping units, clamping components DADL	 Holding brakes DACS
Size			16, 20, 25, 32, 35, 40, 50, 63	
Stroke				
Description	<ul style="list-style-type: none"> For in-house assembly of clamping units Not certified for use in safety-related control systems 	<ul style="list-style-type: none"> KPE: ready-to-install combination of clamping cartridge KP and housing Wide range of mounting options 	<ul style="list-style-type: none"> Clamping unit DADL-EL: for quarter turn actuator DRRD, for mechanical locking in the end positions to prevent unwanted movement in unpressurized condition Clamping component DADL-EC: for quarter turn actuator DRRD, for securing an intermediate position in combination with the clamping unit DADL-EL Without actuator 	<ul style="list-style-type: none"> Holding function: the piston rod is retained by clamping with frictional locking Emergency braking function: the movement of the piston rod is stopped by clamping with frictional locking With safety functions Compact design Optional: high corrosion protection level Magnetic piston for position sensing
online: →	kp	kpe	dadl	dacs

Customized components – for your specific requirements



Actuators with customized designs

Can't find the pneumatic actuator you need in our catalog?

We can offer you customized components that are tailored to your specific requirements.

Common product modifications:

- Materials for special ambient conditions
- Customized dimensions
- Special strokes
- Customized mounting options
- Implementation of special cylinder functions (cylinder/valve combinations, single-acting principle, etc.)

Many additional variants are possible.

Ask your Festo sales engineer, who will be happy to help:

→ www.festo.com/contact

Telescopic cylinder





Festo can also supply special variants like telescopic cylinders on request – please contact us.



Product overview



Actuators with displacement encoder >

Linear drives with displacement encoder

	 Linear actuators with displacement encoder DDLI	 Standards-based cylinders with displacement encoder DDPC	 ISO cylinders with measuring system DNCI
Piston diameter	25 mm, 32 mm, 40 mm, 63 mm	80 mm, 100 mm	32 mm, 40 mm, 50 mm, 63 mm
Theoretical force at 0.6 MPa (6 bar, 87 psi), advance	295 ... 1870 N	3016 ... 4712 N	415 ... 1870 N
Max. load, horizontal		300 ... 450 kg	45 ... 180 kg
Max. load, vertical		100 ... 150 kg	15 ... 60 kg
Stroke	100 ... 2000 mm	10 ... 2000 mm	10 ... 2000 mm
Description	<ul style="list-style-type: none"> Based on linear actuator DGC-K Without guide With linear potentiometer for contactless measurement Suitable for positioning with stepping motor driver CPX-CMAX Suitable for end-position control with end-position controller CPX-CMPX or SPC11 Measures absolute values Can be used as a measuring cylinder Protection: IP67 For attachment to customer's own guide Supply ports on end face 	<ul style="list-style-type: none"> ISO cylinder to ISO 15552 With linear potentiometer for contactless measurement Suitable for positioning with stepping motor driver CPX-CMAX Suitable for end-position control with end-position controller CPX-CMPX or SPC11 Can be used as a measuring cylinder Piston rod variants Fixed cushioning With optional recirculating ball bearing guide, clamping unit 	<ul style="list-style-type: none"> ISO cylinder to ISO 15552 With integrated linear potentiometer for relative analog, contactless measurement Suitable for servopneumatic applications with stepping motor driver CPX-CMAX, end-position controller CPX-CMPX, or SPC11 and measuring module CPX-CMIX External piston rod thread Piston rod variants With optional recirculating ball bearing guide, clamping unit
online: →	ddli	ddpc	dnci

Actuators with displacement encoder >

Linear drives with displacement encoder

	 Linear actuators with position feedback DGCI	 Linear actuators with displacement encoder DFPI
Piston diameter	18 mm, 25 mm, 32 mm, 40 mm, 63 mm	100 mm, 125 mm, 160 mm, 200 mm, 250 mm, 320 mm
Theoretical force at 0.6 MPa (6 bar, 87 psi), advance	153 ... 1870 N	4712 ... 48255 N
Max. load, horizontal		
Max. load, vertical		
Stroke	100 ... 2000 mm	40 ... 990 mm
Description	<ul style="list-style-type: none"> With guide With linear potentiometer for absolute, contactless measurement Suitable for servopneumatic applications with stepping motor driver CPX-CMAX, end-position controller CPX-CMPX, or SPC11 and measuring module CPX-CMIX Supply ports optionally on end face or front 	<ul style="list-style-type: none"> Mounting interfaces to ISO 15552 on bearing and end caps Sturdy tie rod design Integrated air supply With optional integrated linear potentiometer or fully integrated valve positioner IP65, IP67, IP69K, NEMA4 As per EU explosion protection directive (ATEX)
online: →	dgci	dfpi

Actuators with displacement encoder >

Swivel modules with displacement encoder



**Quarter turn actuators with angular displacement encoder
DSMI-B**

Piston diameter	40 mm
Theoretical torque at 0.6 MPa (6 bar, 87 psi)	20 Nm
Max. mass moment of inertia, horizontal	0.12 kgm ²
Max. mass moment of inertia, vertical	0.12 kgm ²
Position sensing	For proximity sensor, With integrated angle measurement system
Swivel angle	0 ... 272 deg
Cushioning	Elastic cushioning rings/pads at both ends
Description	<ul style="list-style-type: none"> • With rotary vane • Integrated rotary potentiometer • Suitable for servopneumatic applications with stepping motor driver CPX-CMAX, end-position controller CPX-CMPX, or SPC11 and measuring module CPX-CMIX • Compact design
online: →	dsmi

Axis controller

Axis controllers



**Axis controllers
CPX-CMAX**





**End-position controllers
SPC11**





No. of axis strings	1	
Axes per string	1	
Digital inputs		8, as per IEC 61131-2, Positive logic (PNP), No galvanic isolation
Digital outputs		5
Description	<ul style="list-style-type: none"> • Fits perfectly into our holistic product portfolio of electromechanical actuators, motors, drive controllers and control systems • Servo pneumatic controllers as CPX module, supports pneumatic actuators with piston rod actuators, rodless actuators, and quarter turn actuators • Force and position control • Use with all fieldbus/Ethernet and controllers CEC available on CPX • Easy commissioning thanks to auto identification function • Rapid commissioning and comprehensive diagnostics with FCT configuration software (Festo Configuration Tool) 	<ul style="list-style-type: none"> • Quickly and smoothly into the end position with two additional intermediate positions • Electronic end-position cushioning • Quick and easy commissioning: configure, teach, done • Supports pneumatic actuators with piston rod actuators, rodless actuators and rotary actuators
online: →	cpx-cmax	spc11

Product overview



Displacement encoders

	 Displacement encoders MLO-POT-TLF	 Displacement encoders MLO-POT-LWG	 Linear measuring systems MME-MTS-TLF
Stroke	225 ... 2000 mm	100 ... 750 mm	225 ... 2000 mm
Measuring principle of linear potentiometer	Analog	Analog	Digital
Output signal	Analog	Analog	CAN protocol type SPC-AIF
Displacement resolution	0.01 mm	0.01 mm	<0.01 mm
Description	<ul style="list-style-type: none"> • Conductive plastic potentiometer • Absolute measurement with high resolution • High travel speed and long service life • Plug-in connections 	<ul style="list-style-type: none"> • Connecting rod potentiometer • Absolute measurement with high resolution • Long service life • IP65 Rating • Plug-in connections 	<ul style="list-style-type: none"> • Measuring principle: magnetostrictive • Contactless with absolute measurement • High travel speed • System product for servopneumatic positioning technology and Soft Stop • IP65 Rating
online: →	mlo	mlo	mme

Proportional directional control valves

	 Proportional directional control valves VPWI	 Proportional directional control valves VPWP	 Proportional directional control valves MPYE	 Proportional directional control valves VPWS
Valve function	3-way proportional directional control valve	5/3 proportional directional control valve, closed	5/3, closed	2/2 proportional directional control valve, closed
Pneumatic connection 1	G1/8	G1/4, G1/8, G3/8	G1/4, G1/8, G3/8, M5	Cartridge 7.5 mm, Cartridge 8 mm, Cartridge 15 mm
Operating pressure for positioning/soft stop		4 ... 8 bar		
Operating pressure [MPa]	0 ... 1.3 MPa	0 ... 1 MPa	0 ... 1 MPa	0 ... 1 MPa
Operating pressure	0 ... 13 bar	0 ... 10 bar	0 ... 10 bar	0 ... 10 bar
Standard nominal flow rate	490 l/min	350 ... 2000 l/min	100 ... 2000 l/min	
Description	<ul style="list-style-type: none"> • Dynamic range up to a maximum of 180Hz • Full graphic display • Stroke limitation • Adjustable incline • Actual value in pressure or stroke • Food grade grease NSFH1 	<ul style="list-style-type: none"> • Controlled piston spool valve • Digital actuation • Integrated pressure sensors for monitoring function and force control • With auto identification • Diagnostic function • Integrated digital output, e.g. for a clamping/brake unit • Suitable for servo-pneumatic applications with stepping motor driver CPX-CMAX and end-position controller CPX-CMPX 	<ul style="list-style-type: none"> • Controlled piston spool valve • Analog actuation • Setpoint input as analog voltage signal (0 ... 10 V) • Suitable for servo-pneumatic applications with SPC11 end-position controller 	<ul style="list-style-type: none"> • Directly actuated poppet valve • Operating medium: air, oxygen, inert gases • Extremely small and lightweight • Compact and cost-effective • Mounting: on sub-base
online: →	vpwi	vpwp	mpye	vpws

Sensor interfaces

	 Sensor interfaces CASB	 Measured-value transducers DADE
Diagnostic function	Indication via LED	Indication via LED
Nominal operating voltage DC	24 V	24 V
Degree of protection	IP65	IP65, IP67
Electrical connection output, connection type	Plug	
Electrical connection output, connection technology	M12x1 A-coded as per EN 61076-2-101	
Electrical output connection, number of pins/wires	8	
Electrical connection, displacement encoder		Socket, 8-pin, M12
Type of mounting	With through-hole for M4 screw	With through-hole
Description	<ul style="list-style-type: none"> • Fits perfectly into our holistic product portfolio of electromechanical actuators, motors, drive controllers and control systems • For actuating pneumatic positioning actuators with the latest servopneumatic systems such as CPX-CMAX, CPX-CMPX, and CPX-CMIX • Short connector cables for analog signals, secure digitized bus transmission • Convenient plug and work concept with auto identification and comprehensive diagnostics • High degree of protection IP67 	<ul style="list-style-type: none"> • For ISO cylinders DNCI and DDPX • Converts sensor signals into voltage or current signals • Mounting via through-holes
online: →	casm	dade

Product overview

Cables and accessories >

Connecting cables for valves

	 <p>Connection/socket cables KMPYE-AIF, KMPYE-5</p>
Electrical connection, connection type	Socket, Cable, Plug
Electrical connection, cable outlet	Straight
Electrical connection, design	Round
Electrical connection, connection technology	M12x1 A-coded as per EN 61076-2-101, M9x0.5, Open end
Electrical connection, number of pins/wires	4, 7
Cable length	0.3 ... 5 m
Description	<ul style="list-style-type: none"> • For solenoid coils with thread M12x1 A-coded according to EN 61076-2-101 • For connection of Proportional directional control valves MPYE with end-position controller SPC11 • Cable length 0.3 ... 5 m • With PVC or PUR cable • Ambient temperature -25 ... +80 °C
online: →	kmpye

Cables and accessories >

Plug connectors for control systems

	 <p>Plugs FBS-SUB-9-WS</p>
Fieldbus interface	Sub-D, 9-pin, socket, Sub-D, 9-pin, plug
Electrical connection 1	Socket, Sub-D, 9-pin, Sub-D plug, 9-pin
Electrical connection 2	Screw terminal
Degree of protection	IP20
Description	<ul style="list-style-type: none"> • Plug connector for bus connection CAN bus and PROFIBUS • Cable connection 2x horizontal or 2x vertical • Printed circuit terminal block with screw connector
online: →	fbs-sub-9-ws



Product overview

Software tools

03 Electromechanical actuators

Electric Motion Sizing



Find the right electric or electro-mechanical servo drive.

This is how you can quickly and easily find the right electromechanical drive solution for your application:

Electric Motion Sizing, the online sizing and simulation tool for electric drives (servo drive controller and motors = servo drive package) as well as for electromechanical drive solutions (= electromechanical servo drive package consisting of servo drive controller and motors as well as mechanics) supports you in this process.

This tool can be found at

→ www.festo.com/x/electric-motion-sizing

Simplified Motion Series – Solution Finder



For the first time, the simplicity of pneumatics is now combined with the advantages of electric automation thanks to the Simplified Motion Series.

These integrated actuators are the perfect solution for all users who are looking for an electric alternative for very simple movement and positioning tasks, but don't want the commissioning process for traditional electric actuator systems that can often be quite complex.

This tool can be found at

→ www.festo.com/x/simplified-motion-series

CO2 values and TCO Guide



CO2 values and TCO for your application.

Take a quantum leap in automation technology. By using suitable components from Festo in an intelligent way, you can lower the energy consumption of your systems, thereby making targeted reductions to your production's carbon emissions.

This tool can be found at

→ www.festo.com/x/co2-tco

Connectivity Finder





This tool can be used to find the optimum way to connect a Festo solution to your preferred (non-Festo) controller. You will also be provided with expert knowledge for your selected connection option, making it really easy to integrate the Festo solution into your machine.

This tool can be found at



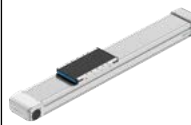
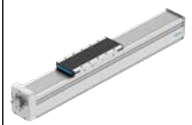

→ www.festo.com/x/connectivity-finder

Electrical linear drives



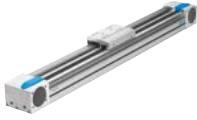

	 Toothed belt axis ELGD-TB-KF	 Toothed belt axis ELGD-TB-KF-WD	 Ball screw axis ELGD-BS-KF	 Ball screw axis ELGD-BS-KF-WD
Size	60, 80, 120	100, 120	60, 80, 120	100, 120
Max. feed force F_x	350 ... 1300 N	240 ... 500 N	1550 ... 3520 N	110 ... 1880 N
Repetition accuracy	±0.04 mm, +/-0.1 mm	±0.04 mm, +/-0.1 mm	±0.01 mm, +/-0.01 mm	±0.01 mm, +/-0.01 mm
Working stroke	50 ... 8500 mm	50 ... 8500 mm	50 ... 2500 mm	50 ... 1500 mm
Description	<ul style="list-style-type: none"> • Fits perfectly into our holistic product portfolio of electromechanical actuators, motors, drive controllers and control systems • For applications in which high dynamics and short positioning times are required • For long strokes • Excellent rigidity and guide load capacity for greater load in the same installation space 	<ul style="list-style-type: none"> • Fits perfectly into our holistic product portfolio of electromechanical actuators, motors, drive controllers and control systems • Reduced profile heights offer smaller installation dimensions for handling systems and applications that do not require such high feed forces • For applications in which high dynamics and short positioning times are required • For long strokes • 30% lighter, while rigidity and guide load capacity are still similar to the axis in the standard design 	<ul style="list-style-type: none"> • Fits perfectly into our holistic product portfolio of electromechanical actuators, motors, drive controllers and control systems • For applications that require precision • High reliability and long service life • For large loads • Excellent rigidity and guide load capacity for greater load in the same installation space 	<ul style="list-style-type: none"> • Fits perfectly into our holistic product portfolio of electromechanical actuators, motors, drive controllers and control systems • Reduced profile heights offer smaller installation dimensions for handling systems and applications that do not require such high feed forces • For applications that require precision • High reliability and long service life • For large loads • 30% lighter, while rigidity and guide load capacity are still similar to the axis in the standard design
online: →	elgd-tb	elgd-tb-kf-wd	elgd-bs	elgd-bs-kf-wd

Product overview

Electrical linear drives



	 Toothed belt axes EGC-TB-KF	 Screw axes EGC-BS-KF	 Toothed belt axes EGC-HD-TB	 Screw axes EGC-HD-BS
Size	50, 70, 80, 120, 185	70, 80, 120, 185	125, 160, 220	125, 160, 220
Max. feed force F_x	50 ... 2500 N	400 ... 3000 N	450 ... 1800 N	400 ... 1500 N
Repetition accuracy	+/-0.08 mm, +/-0.1 mm	+/-0.02 mm		+/-0.02 mm
Working stroke	50 ... 8500 mm	50 ... 3000 mm	50 ... 5000 mm	50 ... 2400 mm
Description	<ul style="list-style-type: none"> • Fits perfectly into our holistic product portfolio of electromechanical actuators, motors, drive controllers and control systems • Axis for high speeds and accelerations • Ball bearing guide for high loads and torques • With optional clamping unit, at one or both ends • Profile with optimized rigidity • The motor can be flexibly mounted on 4 sides • 22 types in stock with short delivery times and modular products for custom variants • Long strokes up to 8.5 m possible 	<ul style="list-style-type: none"> • Axis for high repeat accuracy • Ball bearing guide for high loads and torques • With optional clamping unit, at one or both ends • Profile with optimized rigidity • Fits perfectly into our holistic product portfolio of electromechanical actuators, motors, drive controllers and control systems • The motor can be flexibly mounted on 2 sides • 34 types in stock with short delivery times and modular products for custom variants • Strokes up to 3 m possible 	<ul style="list-style-type: none"> • Fits perfectly into our holistic product portfolio of electromechanical actuators, motors, drive controllers and control systems • With heavy-duty guide • Axis for high speeds and accelerations • For high loads and torques, high feed forces • Precision DUO guide rail with high load capacity • Motor can be mounted on 4 sides • For maximum lateral load up to 900 Nm 	<ul style="list-style-type: none"> • Fits perfectly into our holistic product portfolio of electromechanical actuators, motors, drive controllers and control systems • With heavy-duty guide • Axis for high repeat accuracy • With integrated ball screw drive • For maximum loads and torques • Precision DUO guide rail with high load capacity • For maximum lateral load up to 900 Nm • Ideal as a basic axis for linear gantries and cantilever axes • With optional spindle support for maximum travel speed
online: →	egc	egc	egc	egc

Electrical linear drives

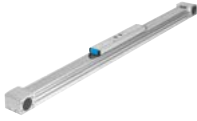

	 Toothed belt axes ELGC-TB-KF	 Spindle axes ELGC-BS-KF	 Spindle axes ELGT-BS	 Toothed belt axes ELGA-TB-G
Size	45, 60, 80	32, 45, 60, 80	90, 120, 160	70, 80, 120
Max. feed force F_x	75 ... 250 N	40 ... 350 N	805 ... 1575 N	350 ... 1300 N
Repetition accuracy	+/-0.1 mm	+/-0.01 mm, +/-0.015 mm	+/-0.02 mm	+/-0.08 mm
Working stroke	200 ... 2000 mm	100 ... 1000 mm	50 ... 1400 mm	50 ... 8500 mm
Description	<ul style="list-style-type: none"> • Fits perfectly into our holistic product portfolio of electromechanical actuators, motors, drive controllers and control systems • Precise and resilient guide • Internal guide and toothed belt • Flexible motor mounting • The belt driven linear actuators, ball screw linear actuator ELGC and mini slides EGSC form a scalable modular system for compact automation • Variants recommended for production facilities for the manufacture of lithium-ion batteries 	<ul style="list-style-type: none"> • Fits perfectly into our holistic product portfolio of electromechanical actuators, motors, drive controllers and control systems • Internal guide and ball screw drive • Space-saving position sensing • Flexible motor mounting • The belt driven linear actuators, ball screw linear actuator ELGC and mini slides EGSC form a scalable modular system for compact automation • Variants recommended for production facilities for the manufacture of lithium-ion batteries 	<ul style="list-style-type: none"> • Fits perfectly into our holistic product portfolio of electromechanical actuators, motors, drive controllers and control systems • High resilience and rigidity due to double-acting guide • Compact design • With ball screw drive • Optimal ratio between installation space and work space due to optimized axis design • Simple integration of motors with mounting kits • Optimized for use in the electronic and automotive industry 	<ul style="list-style-type: none"> • Fits perfectly into our holistic product portfolio of electromechanical actuators, motors, drive controllers and control systems • Integrated plain-bearing guide • For small and medium loads • Low guide backlash • Actuator component for external guides • Speeds up to 5 m/s with high acceleration up to 50 m/s² • Flexible motor mounting • Motor can be mounted on 4 sides
online: →	elgc-tb	elgc-bs	elgt	elga

Product overview

Electrical linear drives



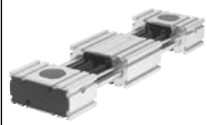

	 Toothed belt axes ELGA-TB-KF	 Toothed belt axes ELGA-TB-RF	 Screw axes ELGA-BS-KF	 Toothed belt axis units ELGE-TB
Size	70, 80, 120, 150	70, 80, 120	70, 80, 120, 150	35
Max. feed force F_x	260 ... 2000 N		650 ... 6400 N	50 N
Repetition accuracy	+/-0.08 mm	+/-0.08 mm	+/-0.02 mm	+/-0.1 mm
Working stroke	50 ... 8500 mm	50 ... 7400 mm	50 ... 3000 mm	50 ... 800 mm
Description	<ul style="list-style-type: none"> Fits perfectly into our holistic product portfolio of electromechanical actuators, motors, drive controllers and control systems Ball bearing guide for high loads and torques High feed forces Precise and resilient guide Speeds up to 5 m/s with high acceleration up to 50 m/s² Optional: Food-safe (for further information, see www.festo.com/certificates/ELGA_KF) The motor can be flexibly mounted on 4 sides Guide and toothed belt protected by cover band 22 types in stock with short delivery times and modular products for custom variants Long strokes up to 8.5 m possible 	<ul style="list-style-type: none"> Fits perfectly into our holistic product portfolio of electromechanical actuators, motors, drive controllers and control systems Integrated roller bearing guide High speeds up to 10 m/s with high acceleration up to 50 m/s² Guide backlash = 0 mm Very good operating behavior under torque load Sturdy alternative to the ball bearing guide As an actuator for external guides, especially for high speeds Motor can be mounted on 4 sides 	<ul style="list-style-type: none"> Fits perfectly into our holistic product portfolio of electromechanical actuators, motors, drive controllers and control systems Internal, precision ball bearing guide with high load capacity for high torque loads Axis for high repeat accuracy For the highest requirements in terms of feed force and accuracy Guide and ball screw drive protected by cover strip Speeds up to 2 m/s with high acceleration up to 15 m/s² Space-saving position sensing Flexible motor mounting 34 preconfigured types and modular product system for custom variants Strokes up to 3 m possible 	<ul style="list-style-type: none"> Fits perfectly into our holistic product portfolio of electromechanical actuators, motors, drive controllers and control systems Complete solution consisting of drive mechanics, motor and servo drive Cost-optimized design for the simplest movement and positioning tasks Ready-to-install unit for quick and easy design Product of the Simplified Motion Series: does not need any external servo drive or any control cabinet for the installation Two control options integrated as standard: digital I/O and IO-Link
online: →	elga	elga	elga	elge-tb

Electrical linear drives



	 Toothed belt axes ELGG	 Toothed belt axes ELGR-TB	 Cantilever axes ELCC-TB-KF	 Electric slides EGSK
Size	35, 45, 55	35, 45, 55	60, 70, 90, 110	15, 20, 26, 33, 46
Max. feed force F_x	50 ... 350 N	50 ... 350 N	300 ... 2500 N	19 ... 392 N
Repetition accuracy	+/-0.1 mm	+/-0.1 mm	+/-0.05 mm	+/-0.003 - +/-0.004 mm, +/-0.003 - +/-0.01 mm, +/-0.01 mm
Working stroke	50 ... 1200 mm	50 ... 1500 mm	50 ... 2000 mm	25 ... 840 mm
Description	<ul style="list-style-type: none"> • Toothed belt axis with two opposing slides • With low-cost plain bearing and precise ball bearing guide • Optional central support improves the rigidity • Motor can be mounted on 4 sides 	<ul style="list-style-type: none"> • Optimum price/performance ratio • Ready-to-install unit for quick and easy design • With plain or ball bearing guide • Motor can be mounted on 4 sides 	<ul style="list-style-type: none"> • Fits perfectly into our holistic product portfolio of electromechanical actuators, motors, drive controllers and control systems • Axis for high speeds and accelerations • Very low moving mass due to fixed drive head • High rigidity thanks to innovative design principle • Toothed belt actuator with ball bearing guide • Able to move high loads of up to 100 kg vertically • Long strokes up to 2 m possible • Sustainable thanks to extended life cycle due to simplified reparability 	<ul style="list-style-type: none"> • Fits perfectly into our holistic product portfolio of electromechanical actuators, motors, drive controllers and control systems • Electromechanical linear axis with ball screw drive • Ball bearing guide and ball screw drive without caged ball bearings • Standardized mounting interfaces • Compact design • High rigidity • 22 types in stock with short delivery times and modular products for custom variants
online: →	elgg	elgr	elcc	egsk

Product overview



Electric cylinders and slides

	 Electric actuator EPCC-BS	 Electric cylinders ESBF	 Mini slide EGSC-BS-KF	 Mini slides EGSL-BS
Size	25, 32, 45, 60	32, 40, 50, 63, 80, 100	25, 32, 45, 60	35, 45, 55, 75
Max. feed force F_x	75 ... 1000 N	600 ... 17000 N	20 ... 250 N	75 ... 450 N
Repetition accuracy	+/-0.02 mm	+/-0.01 mm, +/-0.015 mm, +/-0.05 mm	+/-0.015 mm	+/-0.015 mm
Stroke	25 ... 500 mm	30 ... 1500 mm	25 ... 200 mm	50 ... 300 mm
Description	<ul style="list-style-type: none"> • Fits perfectly into our holistic product portfolio of electromechanical actuators, motors, drive controllers and control systems • Low-cost: optimum price-performance ratio • Flexible: wide range of mounting options for the motor • Dynamic: lower internal friction • Anti-rotation, slide-guided piston rod up to 500 mm stroke • Weight-optimized design – ideal for handling systems • Unique: “One-size-down” mounting system for best use of space in combination with toothed belt/spindle axis ELGC • Variants recommended for production facilities for the manufacture of lithium-ion batteries 	<ul style="list-style-type: none"> • Fits perfectly into our holistic product portfolio of electromechanical actuators, motors, drive controllers and control systems • Available with ball screw drive (size 32 ... 100) or lead screw (size 32 ... 50) • Ball screw drive: three spindle pitches make it possible to select the optimal force-speed ratio • Optional: high corrosion protection, IP65 rating, food-safe (see www.festo.com/certificates/ESBF), piston rod extension • Axial or parallel motor mounting • 68 types in stock with short delivery times and modular products for custom variants • Variants recommended for production facilities for the manufacture of lithium-ion batteries 	<ul style="list-style-type: none"> • Fits perfectly into our holistic product portfolio of electromechanical actuators, motors, drive controllers and control systems • Precise guide and ball screw drive • Compact dimensions • Flexible motor mounting • The belt driven linear actuators, ball screw linear actuator ELGC and mini slides EGSC form a scalable modular system for compact automation • Variants recommended for production facilities for the manufacture of lithium-ion batteries 	<ul style="list-style-type: none"> • Fits perfectly into our holistic product portfolio of electromechanical actuators, motors, drive controllers and control systems • Very high rated slide loads, ideal for vertical applications such as press-fitting or joining • Reliable: the completely closed spindle stops dirt or stray small parts getting into the guide area • Axial or parallel motor mounting
online: →	epcc	esbf	egsc-bs	egsl

Integrated electromechanical actuators



	 Mini slide units EGSS-BS-KF	 Toothed belt axis units ELGS-TB-KF	 Spindle axis units ELGS-BS-KF
Size	32, 45, 60	45, 60	32, 45, 60
Max. feed force F_x	60 ... 250 N	65 ... 75 N	40 ... 200 N
Repetition accuracy	+/-0.015 mm	+/-0.1 mm	+/-0.01 mm, +/-0.015 mm
Working stroke	25 mm, 50 mm, 75 mm, 100 mm, 125 mm, 150 mm, 200 mm	50 mm, 200 mm, 300 mm, 500 mm, 600 mm, 800 mm, 1000 mm, 1200 mm, 1500 mm, 1800 mm, 2000 mm	100 mm, 200 mm, 300 mm, 400 mm, 500 mm, 600 mm, 800 mm
Description	<ul style="list-style-type: none"> Fits perfectly into our holistic product portfolio of electromechanical actuators, motors, drive controllers and control systems Complete solution consisting of drive mechanics, motor and servo drive Rigid, resilient and precise linear guide for the absorption of transverse loads and increased anti-twist protection Precise positioning due to smoothly running ball screw drive Product of the Simplified Motion Series: does not need any external servo drive or any control cabinet for the installation Two control options integrated as standard: digital I/O and IO-Link 	<ul style="list-style-type: none"> Fits perfectly into our holistic product portfolio of electromechanical actuators, motors, drive controllers and control systems Complete solution consisting of drive mechanics, motor and servo drive Dynamic XY movements due to loadable toothed belt and loadable recirculating ball bearing guide of the slide Protected against external influences by internal guide Product of the Simplified Motion Series: does not need any external servo drive or any control cabinet for the installation Two control options integrated as standard: digital I/O and IO-Link 	<ul style="list-style-type: none"> Fits perfectly into our holistic product portfolio of electromechanical actuators, motors, drive controllers and control systems Complete solution consisting of drive mechanics, motor and servo drive Precise XY movements due to powerful ball screw drive and loadable recirculating ball bearing guide of the slide Protected against external influences by internal guide Product of the Simplified Motion Series: does not need any external servo drive or any control cabinet for the installation Two control options integrated as standard: digital I/O and IO-Link
online: →	egss	elgs-tb	elgs-bs

Integrated electromechanical actuators

	 Rotary drive units ERMS	 Electric cylinder units EPCS-BS	 Electric cylinder units EPCE-TB
Size	25, 32	32, 45, 60	45, 60
Max. feed force F_x		150 ... 900 N	85 ... 150 N
Repetition accuracy	+/-0.05°, +/-0.1 deg	+/-0.02 mm	+/-0.05 mm
Working stroke			
Description	<ul style="list-style-type: none"> Fits perfectly into our holistic product portfolio of electromechanical actuators, motors, drive controllers and control systems Complete solution consisting of drive mechanics, motor and servo drive Absorption of transverse loads and torques thanks to robust, backlash-free and precise ball bearings on the rotating plate Integrated through-hole for cables and tubing through sealed hollow shaft Product of the Simplified Motion Series: does not need any external servo drive or any control cabinet for the installation Two control options integrated as standard: digital I/O and IO-Link 	<ul style="list-style-type: none"> Fits perfectly into our holistic product portfolio of electromechanical actuators, motors, drive controllers and control systems Precise positioning due to smoothly running ball screw drive Complete solution consisting of drive mechanics, motor and servo drive Simple implementation of pressing and clamping applications for forces up to 900 N Two control options integrated as standard: digital I/O and IO-Link Product of the Simplified Motion Series: does not need any external servo drive or any control cabinet for the installation 	<ul style="list-style-type: none"> Complete solution consisting of drive mechanics, motor and servo drive Innovatively interpreted toothed belt technology for maximum dynamics and minimal positioning times Optimal use in place-critical applications due to minimal zero stroke and extremely compact design Fits perfectly into our holistic product portfolio of electromechanical actuators, motors, drive controllers and control systems Product of the Simplified Motion Series: does not need any external servo drive or any control cabinet for the installation Two control options integrated as standard: digital I/O and IO-Link
online: →	erms	epcs	epce

Product overview

Electric quarter turn actuators



	 Rotary actuators ERMO	 Rotary modules ERMB
Design	Electromechanical rotary actuator, with integrated gearbox	Electromechanical rotary module, with toothed belt
Size	12, 16, 25, 32	20, 25, 32
Max. driving torque	0.15 ... 5 Nm	0.7 ... 8.5 Nm
Max. input speed		900 ... 1350 rpm
Rotation angle	Infinite	Infinite
Repetition accuracy	+/-0.05°, +/-0.1 deg	±0.03°
Gear ratio	7:1, 9:1	3:1, 4:1, 4.5:1
Description	<ul style="list-style-type: none"> • Fits perfectly into our holistic product portfolio of electromechanical actuators, motors, drive controllers and control systems • Integrated motor with gear stage for a compact design • Motor control with encoder to achieve high angular accuracy • Robust output bearings for absorbing high forces and torques • Backlash-free pre-stressed rotating plate with very good axial eccentricity and concentricity properties • Quick and accurate installation 	<ul style="list-style-type: none"> • Fits perfectly into our holistic product portfolio of electromechanical actuators, motors, drive controllers and control systems • Electromechanical rotary module with toothed belt • Compact design • Mounting interfaces on all sides • Stable output shaft bearings • Unlimited and flexible rotation angle
online: →	ermo	ermb

Electric stoppers

Electric stopper cylinders

	 Stopper cylinders, electric EFS
Design	Electric stopper cylinder
Size	20, 50, 100
Position sensing	With Hall sensor
Cushioning length	11.5 ... 18.2 mm
Description	<ul style="list-style-type: none"> • Fast and simple set-up of transfer systems without compressed air • For stopping conveyed goods weighing between 0.25 kg and 100 kg • Status and error messages for visual error diagnostics • Controlled via digital I/O of a higher-level controller, e.g. terminal CPX, makes commissioning easier • Mounting interface for ease of mounting on transfer systems • Adjustable cushioning power
online: →	efsd

Electric handling modules

	 Rotary/lifting modules EHMB	 Rotary gripper modules EHMD
Size	20, 25, 32	40, 50
Stroke per gripper jaw		5 mm, 15 mm
Working stroke	0 ... 200 mm	
Max. output torque	3.15 ... 20 Nm	0.3 ... 1 Nm
Max. driving torque	0.7 ... 6.7 Nm	
Max. input speed	900 ... 1350 rpm	
Max. speed	1.5 m/s	0.025 m/s, 0.07 m/s
Rotation angle	Infinite	Infinite
Repetition accuracy	±0.03°	
Description	<ul style="list-style-type: none"> • Fits perfectly into our holistic product portfolio of electromechanical actuators, motors, drive controllers and control systems • Complete module with combined and configurable rotary/lifting movement • Dynamic, flexible, economical thanks to the modular actuator concept for the linear movement • Hollow axis with large internal diameter makes laying power supply lines easy, convenient, and safe 	<ul style="list-style-type: none"> • Fits perfectly into our holistic product portfolio of electromechanical actuators, motors, drive controllers and control systems • Ideal for small objects in laboratory automation • Infinite electric rotation and electric or pneumatic gripping • Gripping and turning to open and close covers on vials • Optional: fastening with Z-compensation compensates the thread pitch of covers on vials during opening and closing
online: →	ehmb	ehmd

Electric grippers >



Parallel gripper

	 Parallel grippers, electric EHPS
Size	16, 20, 25
Stroke per gripper jaw	10 ... 16 mm
Maximum force on gripper jaw F_z, static	200 ... 450 N
Pneumatic gripper repetition accuracy	0.01 mm, 0.03 mm
Position sensing	For proximity sensor, With Hall sensor, With integrated linear potentiometer, Via IO-Link interface
Description	<ul style="list-style-type: none"> • Fits perfectly into our holistic product portfolio of electromechanical actuators, motors, drive controllers and control systems • Electrical version of the standard parallel gripper DHPS • Ideal for use as a front-end actuator thanks to its low dead weight • Controller-free actuation using digital signals • Gripping force (4-stage) adjustable via ratchet switch or via IO-Link interface • RA1 version with robot connection, enables fast integration in lightweight robot environment
online: →	ehps

Product overview

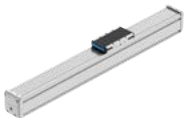

Accessories for electric actuators >

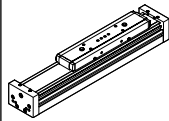
Linear guides

	 Guide axes ELFD	 Electric linear actuators ELFC	 Guide units EAGF	 Guide axes ELFA-KF
Size	60, 80, 120	32, 45, 60, 80	32, 40, 45, 50, 60, 63, 80, 100	70, 80, 120
Stroke	50 ... 5000 mm	100 ... 2000 mm	1 ... 550 mm	50 ... 8500 mm
Guide	Recirculating ball bearing guide	Recirculating ball bearing guide	Recirculating ball bearing guide	Recirculating ball bearing guide
Description	<ul style="list-style-type: none"> For spindle/toothed belt axes with recirculating ball bearing guide ELGD-BS-KF/ELGD-TB-KF (drive axes) Actuatorless linear guide unit with guide and freely movable slide unit For supporting forces and torques in multi-axis applications High torsional resistance Reduced vibrations with dynamic loads 	<ul style="list-style-type: none"> Toothed belt axes with recirculating ball bearing guide ELGA-BS-KF/ELGA-TB-KF (drive axes) Actuatorless linear guide unit with guide and freely movable slide unit For supporting forces and torques in multi-axis applications High torsional resistance Reduced vibrations with dynamic loads 	<ul style="list-style-type: none"> For electric cylinders EPCC, EPCO and ESBF For absorbing high process forces and torques from the process High guide precision 	<ul style="list-style-type: none"> Toothed belt axes with recirculating ball bearing guide ELGA-BS-KF/ELGA-TB-KF (drive axes) Actuatorless linear guide unit with guide and freely movable slide unit For supporting forces and torques in multi-axis applications High torsional resistance Reduced vibrations with dynamic loads
online: →	elfd	elfc	eagf	elfa

Accessories for electric actuators >

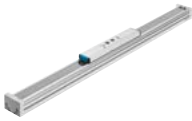
Linear guides

	 Guide axes ELFA-RF	 Electric linear actuators ELFR	 Guide axes EGC-FA
Size	70, 80	35, 45, 55	70, 80, 120, 185
Stroke	50 ... 7000 mm	50 ... 1500 mm	50 ... 8500 mm
Guide	Roller guide	Sliding guide, Recirculating ball bearing guide	Recirculating ball bearing guide
Description	<ul style="list-style-type: none"> For toothed belt axis with roller bearing guide ELGA-TB-RF (drive axes) Actuatorless linear guide unit with guide and freely movable slide unit For supporting forces and torques in multi-axis applications High torsional resistance Reduced vibrations with dynamic loads 	<ul style="list-style-type: none"> For toothed belt axes ELGR-TB (drive axes) For spindle/toothed belt axes EGC (drive axes) For supporting forces and torques in multi-axis applications High torsional resistance 	<ul style="list-style-type: none"> For spindle/toothed belt axes EGC (drive axes) For supporting forces and torques in multi-axis applications High torsional resistance
online: →	elfa	elfr	egc

Customized components – for your specific requirements



Actuators with customized designs

Can't find the electromechanical actuator you need in our catalog?

We can offer you customized components that are tailored to your specific requirements.

Common product modifications:

- Special strokes
- Design for special ambient conditions
- Design optimized for the fitting space
- Design with opposing carriages
- Design with absolute encoder

Many additional variants are possible.

Ask your Festo sales engineer, who will be happy to help:

→ www.festo.com/contact

Product overview

03

Electromechanical actuators



Product overview

Software tools



Configurator for quarter turn actuator units KDFP



Choose a pure drive unit without process valve for automation of existing process valves. Simply enter the required parameters in the input screen and the configurator will suggest suitable solutions.



You can find the configurator at
→ www.festo.com/process

Quarter turn actuators for process valves



	 Quarter turn actuator units KDFP-DFPD	 Quarter turn actuators DFPD	 Quarter turn actuators DFPD-C
Design	Gear rack/pinion	Scotch yoke system, Gear rack/pinion	Gear rack/pinion
Mode of operation	Double-acting, Single-acting	Double-acting, Single-acting	Single-acting
Size of valve actuator	10, 20, 40, 80, 120, 160, 240, 300, 480, 700, 900, 1200, 2300	10, 20, 40, 60, 80, 120, 160, 240, 300, 480, 700, 900, 1200, 2300, 3500, 4500, 6500, 9500	20, 40, 80, 120, 160, 240, 300, 480, 700, 900, 1200, 2300
Flange hole pattern	F03, F04, F05, F07, F10, F12, F14, F16	F03, F04, F05, F07, F10, F12, F14, F16, F0507, F0710, F1012, F1216, F1625	F05, F07, F10, F12, F14, F16
Swivel angle	90 deg	90 deg, 120 deg, 135 deg, 180 deg	90 deg
Operating pressure [MPa]	0.2 ... 0.8 MPa	0.2 ... 0.8 MPa	0.2 ... 0.8 MPa
Operating pressure	2 ... 8 bar	2 ... 8 bar	2 ... 8 bar
Operating pressure [psi]	29 ... 116 psi	29 ... 116 psi	29 ... 116 psi
Ambient temperature	-50 ... 150°C	-50 ... 150°C	-20 ... 80°C
Safety function		The safety function consists of the drive switching to the defined safety switching position. This switching movement is achieved by pressurizing the corresponding pressure chamber with compressed air. The value of the torque generated depends on the pressure difference between the two pressure chambers separated by the piston. The safety function consists of the drive switching to the defined safety switching position when the compressed air is switched off and the spring chamber is exhausted. This switching movement is achieved by the spring force of the spring assembly.	The safety function consists of the drive switching to the defined safety switching position when the compressed air is switched off and the spring chamber is exhausted. This switching movement is achieved by the spring force of the spring assembly.
Safety integrity level (SIL)		Up to SIL 2 low demand mode, up to SIL 3 in a redundant architecture, up to SIL 1 high demand mode	Up to SIL 2 low demand mode, up to SIL 3 in a redundant architecture, up to SIL 1 high demand mode
Description	<ul style="list-style-type: none"> • Quarter turn actuator unit comprising quarter turn actuator DFPD and accessories • Select, size and order easily, quickly and reliably via the configurator • Optionally with pilot valve • Optionally with positioner • Optionally with position indicator • Optionally with end position feedback • Optionally with the required mounting adapters or reducing sleeves for mounting on the valve body 	<ul style="list-style-type: none"> • Uniform torque characteristic across the entire rotation angle of 90° with the double-acting version • Process valve connector according to ISO 5211 • Mounting hole pattern to VDI/VDE 3845 • Sturdy, non-slip, and easy-to-clean aluminum housing • Long service life, low wear • Version with swivel angle 120°, 135°, 180° for the sizes 40, 120, 240, 480, double-acting • Variants with safety functions • As per EU explosion protection directive (ATEX) 	<ul style="list-style-type: none"> • Suitable for process automation in the chemical and petrochemical industries • Extended NAMUR interface according to VDI/VDE 3847 • Anti-blow-out screws for end-position adjustment • Hard anodized cover to prevent surface damage • Non-ferrous metal-free spring sets • Version with compressed air ducts in housing for direct attachment of positioner and pilot valve on the drive – without extra barbed tubing connectors
online: →	kdfp	dfpd	dfpd

Product overview

Quarter turn actuators for process valves

	 <p>Quarter turn actuators with heavy-duty guide DFPD-HD</p>	 <p>Quarter turn actuators DAPS</p>
Design	Scotch yoke system	Scotch yoke system
Mode of operation	Double-acting, Single-acting	Double-acting, Single-acting
Size of valve actuator	9000, 18000, 32000	0008, 0015, 0030, 0053, 0060, 0090, 0106, 0120, 0180, 0240, 0360, 0480, 0720, 0960, 1440, 1920, 2880, 3840, 4000, 5760, 8000
Flange hole pattern	F25, F30, F35	F03, F04, F05, F07, F10, F12, F14, F16, F25
Swivel angle	90 deg	90 deg, 92 deg
Operating pressure [MPa]	0.1 ... 0.85 MPa	0.1 ... 0.84 MPa
Operating pressure	1 ... 8.5 bar	1 ... 8.4 bar
Operating pressure [psi]	14.5 ... 123.25 psi	
Ambient temperature	-20 ... 80°C	-50 ... 150°C
Safety function		
Safety integrity level (SIL)		Up to SIL 2 high demand mode, Up to SIL 2 low demand mode
Description	<ul style="list-style-type: none"> • Ideal for applications with high torques up to max. 32,000 Nm • Extremely modular for a variety of uses: configurable spring forces, a choice between right or left direction of rotation and mechanical or hydraulic manual override • With safety functions • NAMUR port pattern for solenoid valves to VDI/VDE 3845 • Variants in accordance with EU Explosion Protection Directive (ATEX) 	<ul style="list-style-type: none"> • High breakaway torques • Sustainable thanks to extended life cycle due to simplified repairability • Flange hole pattern to ISO 5211 • Mounting hole pattern to VDI/VDE 3845 • Available with handwheel as a manual emergency override • Corrosion-resistant variant made from stainless steel • As per EU explosion protection directive (ATEX) • With safety functions
online: →	dfpd	daps



Linear drives for process valves

	 Piston actuators DFPK	 Linear actuators DFPC	 Linear actuators with displacement encoder DFPI
Design		Piston, Piston rod, Tie rod, Cylinder barrel	Piston, Piston rod, Tie rod, Cylinder barrel
Mode of operation		Double-acting	Double-acting
Piston diameter		80 mm, 100 mm, 125 mm, 160 mm, 200 mm, 250 mm, 320 mm	100 mm, 125 mm, 160 mm, 200 mm, 250 mm, 320 mm
Size of valve actuator	46, 75	80, 100, 125, 160, 200, 250, 320	100, 125, 160, 200, 250, 320
Stroke	17 ... 20 mm	10 ... 1600 mm	40 ... 990 mm
Operating pressure [MPa]	0.5 ... 1 MPa	0.2 ... 0.8 MPa	0.3 ... 0.8 MPa
Operating pressure	5 ... 10 bar	2 ... 8 bar	3 ... 8 bar
Operating pressure [psi]	72.5 ... 145 psi	29 ... 116 psi	43.5 ... 116 psi
Ambient temperature	0 ... 60°C	-20 ... 80°C	-20 ... 80°C
Description	<ul style="list-style-type: none"> • Stainless steel design • Available as a valve drive with angle seat valve VZXA and as a valve block solution • Linear actuating motion • High actuating forces • As per EU explosion protection directive (ATEX) 	<ul style="list-style-type: none"> • Robust and corrosion-resistant tie-rod design • Ideal for use in harsh ambient conditions • Numerous configuration options • Variants with fastening interface in accordance with ISO 5210 or ISO 15552 with extended tie rods 	<ul style="list-style-type: none"> • Mounting interfaces to ISO 15552 on bearing and end caps • Sturdy tie rod design • Integrated air supply • With optional integrated linear potentiometer or fully integrated valve positioner • IP65, IP67, IP69K, NEMA4 • As per EU explosion protection directive (ATEX)
online: →	dfpk	dfpc	dfpi

Product overview

Accessories



Limit switch attachments

	 Limit switch attachments SRBK	 End switch attachments SRBC	 End switch attachments SRBG
Information on housing materials	PA, PA66, electrically conductive	Die-cast aluminum	PBT
Operating voltage range AC	0 ... 230 V	0 ... 230 V	
DC operating voltage range	0 ... 175 V	0 ... 175 V	6 ... 60 V
Measuring principle	Inductive, Magnetic reed, Mechanical/ electrical	Inductive, Magnetic reed, Mechanical/ electrical	Inductive
Switching element function	N/O contact, Toggle switch, single-pin	N/C contact, N/O contact, Toggle switch, single-pin	N/C contact, N/C contact/N/O contact switchable, N/O contact
Safety integrity level (SIL)	SIL 3	SIL 3	SIL 2
Description	<ul style="list-style-type: none"> • Robust plastic housing with UV resistance • Different switch variants – mechanical, inductive and reed switches • Multifunctional mounting flange adapter for adaptations on the ISO3845 interface • Variants with M12 plug connection for easy installation (Plug&Play) 	<ul style="list-style-type: none"> • Pre-assembled mounting adapter for ease of installation • Trip cams can be set easily without additional tools • Sturdy, corrosion-resistant design, ideal for use in harsh operating conditions • Clearly visible 3D position indicator allows rapid detection of the current position of the quarter turn actuator • With safety functions • Variants in accordance with EU Explosion Protection Directive (ATEX) 	<ul style="list-style-type: none"> • Compact housing with M12 plug connection • Direct mounting on quarter turn actuators to VDI/VDE 3845 • For quarter turn actuators for the process automation with position indicators • AS-Interface® version with extended addressing options • LED status indicator for switching status, supply voltage and solenoid valve output • With safety functions • Variants in accordance with EU Explosion Protection Directive (ATEX)
online: →	srbk	srbc	srbg

04 Pneumatic drives for process valves

Accessories

Limit switch attachments

	 End switch attachments SRBE	 Limit switch attachments SRAP	 Limit switch box SRBI
Information on housing materials	Die cast aluminum, painted	Wrought aluminum alloy	PBT
Operating voltage range AC	0 ... 240 V		
DC operating voltage range	0 ... 60 V	15 ... 30 V	10 ... 30 V
Measuring principle	Inductive, Magnetic reed, Mechanical/electrical, For proximity sensor	Magnetic Hall	Inductive
Switching element function	N/C contact, N/O contact, Toggle switch, single-pin, Toggle switch, double-pin		N/O contact
Safety integrity level (SIL)	SIL 3		
Description	<ul style="list-style-type: none"> • Trip cams can be set easily without additional tools • Sturdy, corrosion-resistant design, ideal for use in harsh operating conditions • Clearly visible 3D position indicator allows rapid detection of the current position of the quarter turn actuator • With safety functions • As per EU explosion protection directive (ATEX) 	<ul style="list-style-type: none"> • Based on standard VDI/VDE 3845 (NAMUR) • Analog • For monitoring the position of quarter turn actuators • Sensors based on 2D Hall technology • Variants in accordance with EU Explosion Protection Directive (ATEX) 	<ul style="list-style-type: none"> • Compact housing with M12 plug connection • Direct mounting on quarter turn actuators to VDI/VDE 3845 • For quarter turn actuators for the process automation with position indicators • LED status indicator for switching status and supply voltage
online: →	srbe	srap	srbi

Accessories



Accessories for limit switch attachments

	 Position indicators SASF
Setting range of swivel angle	0 ... 360 deg
Ambient temperature	-40 - 80°C
Type of mounting	as per VDI/VDE 3845
Description	<ul style="list-style-type: none"> • For SRBG, SRBI, SRBC limit switch attachments • Variants for mounting on drive shafts of standard drives according to VDI/VDE 3845 • Variants with adjustable swivel angle • Variants for clockwise and anticlockwise rotating actuators with 90° and 180° rotation • Variants with position indicator in yellow/red, I, T, L design or with 180° arrow
online: →	sasf

Product overview



Accessories

Positioners

	 Positioners CMSH	 Manifold block CAPS	 Positioners CMSX
Mode of operation	Double-acting, Single-acting	Double-acting, Single-acting	Double-acting, Single-acting
Standard nominal flow rate		270 ... 380 l/min	50 ... 130 l/min
Ambient temperature	-40 ... 80°C		-5 ... 60°C
DC operating voltage range			21.6 ... 26.4 V
Operating pressure [MPa]	0.14 ... 0.8 MPa		0.3 ... 0.8 MPa
Operating pressure	1.4 ... 8 bar		3 ... 8 bar
Operating pressure [psi]	20.3 ... 116 psi		43.5 ... 116 psi
Design features	Safety position - pneumatic outlets closed, Safety pneumatic output 2 exhausted, Safety pneumatic output 4 pressurized	Safety position - pneumatic outlets closed, Safety pneumatic output 2 exhausted, Safety pneumatic output 4 pressurized	Safety position – pneumatic outlet 4 exhausted, Safety position – pneumatic output 2 pressurized, Safety position - pneumatic outlets closed
Degree of protection	IP66, IP67		IP65
Type of mounting	With accessories, as per VDI/VDE 3845, to VDI/VDE 3847-2	as per VDI/VDE 3845, to VDI/VDE 3847-2	With accessories
Information about housing material	Aluminum, powder-coated	Aluminum, powder-coated	PC-reinforced
Description	<ul style="list-style-type: none"> • Intelligent, digital electropneumatic positioner with HART communication • Fast and precise position control of single-acting and double-acting pneumatic rotary and linear actuators • With integrated or external path/angular detection • Commissioning, operation, servicing and diagnostics on the local display via the user-friendly software menu or via remote access via EDD-based (Electronic Device Description) or FDT-based (Field Device Tool) transmission • 2-conductor technology • Perfect interaction with the VTOP pneumatic extension modules • Variants with safety functions • Sustainable operation due to efficient control 	<ul style="list-style-type: none"> • Prepared for positioner CMSH-V-SD with the mechanical interface in the version for sub-base and switchable with mode of operation in the single-acting/double-acting version • Determines the mode of operation of the positioner CMSH-V-SD • Variants with mechanical interface according to VDI/VDE 3845 or according to VDI/VDE 3847-2 • Variants with or without pressure gauge connection • With safety functions 	<ul style="list-style-type: none"> • Digital, electropneumatic positioner • Simple and efficient position control of single-acting and double-acting pneumatic rotary and linear actuators • Sustainable thanks to extended life cycle due to simplified reparability • With integrated or external path/angular detection • Simple commissioning through automatic initialization function • Intuitive menu navigation • 4-conductor technology • Variants with safety functions
online: →	cmsh	caps	cmsx

Accessories



Pilot valves

	 Solenoid valves VSNC	 Solenoid valves VSNC-G1/8	 Solenoid valves VOFC
Valve function	5/2, bistable, 5/2 or 3/2 switchable, 5/3, pressurized, 5/3, exhausted, 5/3, closed	3/2, closed, monostable, 5/2, monostable, Connections exchanged	3/2, closed, monostable, 5/2, bistable, 5/2, monostable
Operating pressure [MPa]	0.15 ... 1 MPa	0.25 ... 0.8 MPa	0 ... 1 MPa
Operating pressure	1.5 ... 10 bar	2.5 ... 8 bar	0 ... 10 bar
Ambient temperature	-20 ... 60°C	-20 ... 50°C	-25 ... 60°C
Pneumatic connection 1	1/4 NPT, G1/4, QS-1/4, QS-10, QS-3/8, QS-5/16, QS-6, QS-8	G1/8	1/4 NPT, 1/2 NPT, NAMUR connection diagram, G1/2, G1/4, M5
Standard nominal flow rate	800 ... 1350 l/min	400 l/min	595 ... 2794 l/min
Explosion prevention and protection	Class I, Div. 1 (US), Class I, Div. 2 (US), Class II, Div. 1 (US), Class II, Div. 2 (US), Class III, Div. 1 (US), Class III, Div. 2 (US), Zone 0 (IEC-EX), Zone 0 (KR), Zone 1 (ATEX), Zone 1 (IEC-EX), Zone 1 (KR), Zone 2 (ATEX), Zone 2 (KR), Zone 20 (IEC-EX), Zone 21 (ATEX), Zone 21 (IEC-EX), Zone 21 (KR), Zone 22 (ATEX), Zone 22 (KR)		Zone 1 (ATEX), Zone 1 (IEC-EX), Zone 1 (KR), Zone 2 (ATEX), Zone 21 (ATEX), Zone 21 (IEC-EX), Zone 21 (KR), Zone 22 (ATEX)
Safety integrity level (SIL)			Up to SIL 3 high demand mode, Up to SIL 3 low demand mode
Description	<ul style="list-style-type: none"> NAMUR port pattern for solenoid valves to VDI/VDE 3845 Rotatable seal for 3/2- or 5/2-way valve Wide choice of EX solenoid systems Sturdy and powerful Extended temperature range Outstanding value for money All solenoid coils can be used on an armature tube The VSNC-...FN variant achieves greater industrial energy efficiency with reduced power consumption 	<ul style="list-style-type: none"> NAMUR port pattern for solenoid valves to VDI/VDE 3845 Compact, cost-effective, powerful Especially suitable for rotary actuators DAPS and DFPD with plug pattern according to VDI/VDE 3845 Extended temperature range Electrical connection with plug pattern form C, according to EN 175301-803 Solenoid coil 24 V integrated Outstanding value for money 	<ul style="list-style-type: none"> Suitable for process automation in the chemical and petrochemical industries Suitable for outdoor use under harsh, dusty ambient conditions Especially suitable for quarter turn actuators thanks to NAMUR flange pattern Pneumatic valve can switch between internal and external pilot air Variants with safety functions Variants in accordance with EU Explosion Protection Directive (ATEX)
online: →	vsnc	vsnc	vofc

Product overview

Accessories

Pilot valves

	 <p>Solenoid valves VOFD</p>	 <p>Pilot valves VOFX</p>
Valve function	3/2, closed, monostable, semi-automatic, 3/2, closed, monostable	3/2, closed, monostable
Operating pressure [MPa]	0 ... 1.2 MPa	-0.09 ... 0.8 MPa
Operating pressure	0 ... 12 bar	-0.9 ... 8 bar
Ambient temperature	-50 ... 60°C	-10 ... 50°C
Pneumatic connection 1	1/4 NPT, NAMUR connection diagram, G1/4, M5	G1/8
Standard nominal flow rate	52 ... 1900 l/min	50 l/min
Explosion prevention and protection	Zone 1 (ATEX), Zone 2 (ATEX), Zone 21 (ATEX), Zone 22 (ATEX)	Zone 1 (ATEX), Zone 1 (BR), Zone 2 (ATEX), Zone 21 (ATEX), Zone 21 (BR), Zone 21 (CN), Zone 21 (IEC-EX), Zone 22 (ATEX)
Safety integrity level (SIL)	Up to SIL 3 high demand mode, Up to SIL 3 low demand mode	
Description	<ul style="list-style-type: none"> • Suitable for process automation in the chemical and petrochemical industries • Suitable for outdoor use under harsh, dusty ambient conditions • Especially suitable for quarter turn actuators thanks to NAMUR flange pattern • Variants with safety functions • Variants in accordance with EU Explosion Protection Directive (ATEX) 	<ul style="list-style-type: none"> • For angle seat valves VZXF and VZXA • For use wherever valve manifolds are not economically or technically viable • Manual override, detenting
online: →	vofd	vofx

Accessories

Application-specific valve manifolds

	 <p>Valve manifolds VTOP</p>
Size	100 mm
Variants	Manifold block for safety functions, HFT0 prepared for exhaust, VDI/VDE 3845, Manifold block for safety functions, HFT0 prepared for exhaust, VDI/VDE 3847, Manifold block for safety functions, HFT1 prepared for exhaust, VDI/VDE 3847, End plate, double-acting, active direction, can be switched, Filter regulator, pressure range 0.5 ... 12 bar, grade of filtration 40 µm, Filter regulator, pressure range 0.5 ... 12 bar, grade of filtration 5 µm, Module for reaching a specific end position in case of a pressure failure, Volume booster, double-acting, Volume booster, single-acting
Operating pressure [MPa]	0 MPa, 0.9 MPa
Operating pressure	0 bar, 9 bar
Operating pressure [psi]	0 psi, 130.5 psi
Pneumatic connection	Sub-base design, airing
Description	<ul style="list-style-type: none"> • Innovative, modular, compact complete solution for control applications • Modules such as fail-safe, volume booster and filter regulator can be combined with one another as desired, are easy to install, and can be extended and retrofitted without any problems • Patented integrated air ducting to supply all modules as well as actuator and positioner, without leak-prone, external pipework • Standardized mounting interface for direct attachment of a positioner according to VDI/VDE 3847-2 • Optimized for positioner CMSH for controlling single and double-acting quarter turn and linear drives • Suitable for quarter turn actuators DFDP-C with mechanical interface according to VDI/VDE 3847-2 and for linear drives DFPI-NB3 based on ISO 15552 • Sustainable in operation due to leakage reduction at sealing points
online: →	vtop

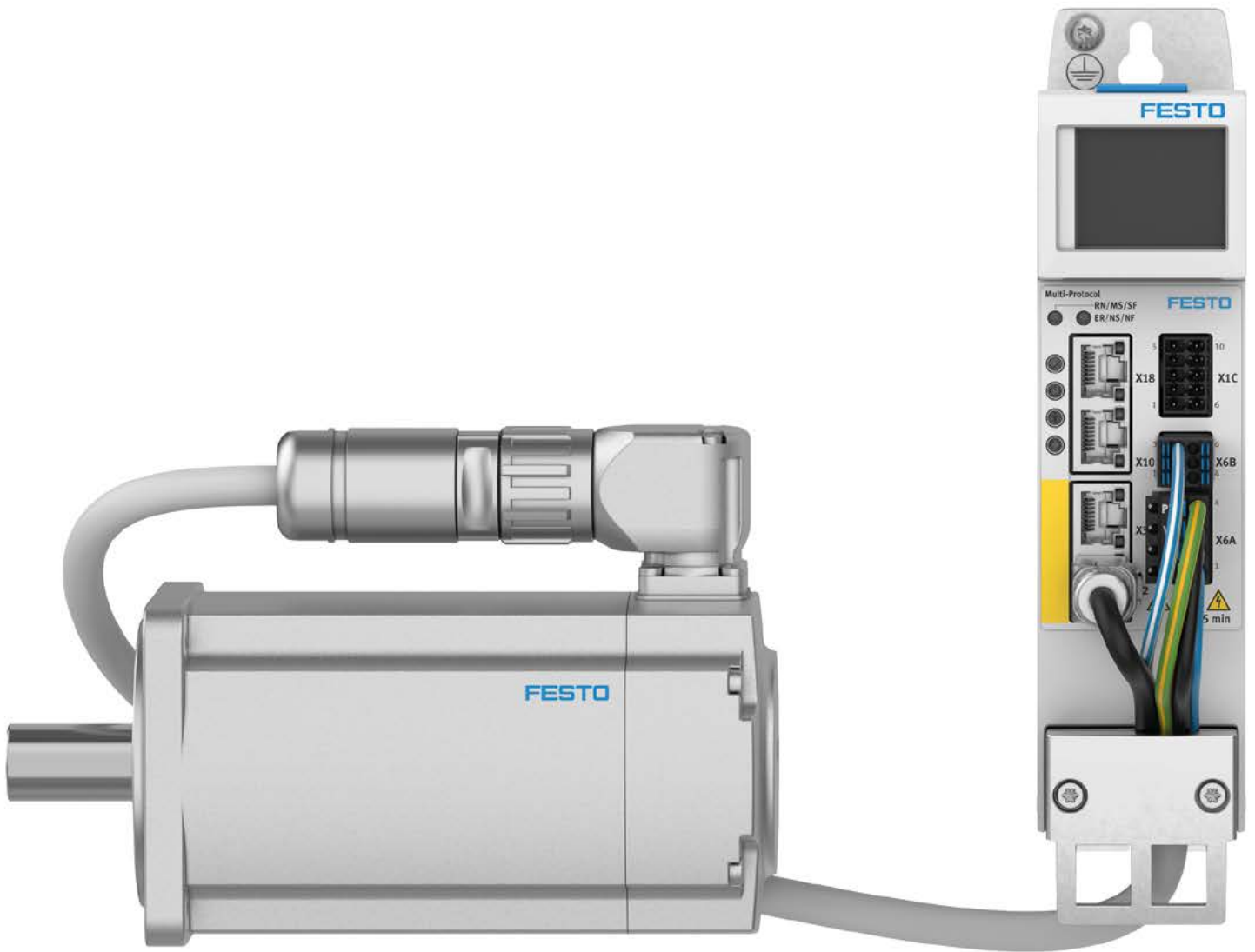

Product overview

Software tools

05 Motors and servo drives

Festo Configuration Tool (FCT)



The „Festo Configuration Tool“ is a configuration and parameterization software program that supports all Festo devices, in particular motor controllers.

The software is extremely flexible, provides full support for the device properties and is simple and intuitive to operate.

The user is guided step-by-step through the commissioning process while each individual step is checked.

The „Festo Configuration Tool“ parameterization software can be found at www.festo.com/fct > Section „More useful tools for the first start“

Electric Motion Sizing



Find the right electric or electro-mechanical servo drive.

This is how you can quickly and easily find the right electromechanical drive solution for your application:

Electric Motion Sizing, the online sizing and simulation tool for electric drives (servo drive controller and motors = servo drive package) as well as for electromechanical drive solutions (= electromechanical servo drive package consisting of servo drive controller and motors as well as mechanics) supports you in this process.

This tool can be found at www.festo.com/x/electric-motion-sizing

Simplified Motion Series – Solution Finder





For the first time, the simplicity of pneumatics is now combined with the advantages of electric automation thanks to the Simplified Motion Series.

These integrated actuators are the perfect solution for all users who are looking for an electric alternative for very simple movement and positioning tasks, but don't want the commissioning process for traditional electric actuator systems that can often be quite complex.



This tool can be found at www.festo.com/x/simplified-motion-series

Servo motors

		
	Servo motors EMMT-AS	Servo motors EMMB-AS
Nominal torque	0.21 ... 82.4 Nm	0.32 ... 2.39 Nm
Nominal rotary speed	1000 ... 7000 rpm	3000 rpm
Motor nominal power	96 ... 8629 W	100 ... 750 W
Peak torque	0.83 ... 183.3 Nm	0.96 ... 7.17 Nm
Max. rotational speed	1654 ... 15600 rpm	5000 ... 6000 rpm
Description	<ul style="list-style-type: none"> • Fits perfectly into our holistic product portfolio of electromechanical actuators, motors, drive controllers and control systems • Technology series – for demanding positioning tasks • A selection of 6 motor sizes in up to 4 overall lengths • Brushless, permanently magnetized synchronous servo motor • Digital absolute linear potentiometer, single-turn or multi-turn • Reliable, highly dynamic, highly precise • Extremely low cogging torque – supports high synchronization even at low rotational speeds • One motor connection (OCP: one cable plug) – one connecting cable for supply and encoder, with orientable plug • Degree of protection IP67 (for motor housing and connection technology) and up to IP65 (on the motor shaft with shaft seal) • Available with holding brake • Optionally with absolute safety encoder, multi-turn 	<ul style="list-style-type: none"> • Fits perfectly into our holistic product portfolio of electromechanical actuators, motors, drive controllers and control systems • Basic series – for cost-sensitive, simple positioning tasks • A selection of 3 motor sizes in up to 2 overall lengths • Brushless, permanently magnetized synchronous servo motor • Digital absolute displacement encoder, single turn; multi-turn optional • Robust, dynamic, accurate • Optimized connection technology • Degree of protection IP65 (for motor housing and line connections (without plug connectors)) and up to IP 54 (on the motor shaft with shaft seal) • Available with holding brake
online: →	emmt	emmb

Stepper motors:

Stepper motors

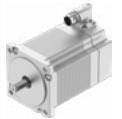
			
	Stepper motors EMMS-ST	Stepper motor EMMB-ST	Stepper motor EMMT-ST
Motor nominal current	1.4 A	1.8 ... 7.5 A	1.8 ... 8.4 A
Max. rotational speed	6000 rpm	600 ... 3200 rpm	430 ... 3200 rpm
Motor holding torque	0.09 Nm	0.25 ... 6.6 Nm	0.25 ... 9.4 Nm
Description	<ul style="list-style-type: none"> • Small increment and high driving torques thanks to 2-phase hybrid technology • Optimized connection technology • Four sizes with flange sizes 28, 42, 57 and 87 • 28 stock types • With incremental encoder for closed loop operation • Degree of protection IP40 (motor shaft), IP54 (sizes 42, 27, 87: motor housing and plug connection), IP65 (size 28: motor housing and plug connection) • Available with holding brake 	<ul style="list-style-type: none"> • Fits perfectly into our holistic product portfolio of electromechanical actuators, motors, drive controllers and control systems • Motor in IP20 (IP40 for motor shaft) • Absolute encoder, single or multiturn (without battery) • 3 flange sizes MH: 0.22 Nm ... 6.6 Nm • Available with holding brake • Automatic motor detection via “electronic rating plate” with motor correction table • Application range down to -15°C possible • OCP cable (one cable plug) with space-saving plug, can be positioned to the front or rear • Cable length up to 25 M 	<ul style="list-style-type: none"> • Fits perfectly into our holistic product portfolio of electromechanical actuators, motors, drive controllers and control systems • Motor in IP65 (IP40 for motor shaft) • Absolute encoder, single or multiturn (without battery) • 3 flange sizes MH: 0.25 Nm ... 9.4 Nm • Available with holding brake • Automatic motor detection via “electronic rating plate” with motor correction table • Application range down to -15°C possible • OCP line (One Cable Plug) with solid M17 plug, can be rotated 310° • Cable length up to 25 M
online: →	emms	emmb	emmt

Product overview

Software tools

Automation Suite commissioning software



A ready-to-use drive system quickly and reliably – in just one software program, the Festo Automation Suite combines parameterization, programming and maintenance of complete drive systems, from the mechanics to the controller. Perfect for making industrial automation simple, efficient and seamless.

Servo drive plug-in CMMT-AS

- An operational drive system in just 5 steps – parameterization takes place almost fully automatically with the commissioning wizard
- Advanced editing with the expert view: full access to all device parameters
- Conveniently install the plug-in using the software

This tool can be found at

→ www.festo.com/AutomationSuite

Connectivity Finder





This tool can be used to find the optimum way to connect a Festo solution to your preferred (non-Festo) controller. In addition, you will be provided with expert knowledge for your selected connection option, making the integration of the Festo solution into your machine extremely easy.

This tool can be found at

→ www.festo.com/x/connectivity-finder

Electric servo drives >

Servo drive

	 Servo drives CMMT-AS	 Motor controllers CMMP-AS	 Servo drives CMXL-ST6
Nominal current		2 ... 13 A	
Nominal operating voltage AC	230 ... 400 V	230 ... 400 V	
Nominal operating voltage phases	1-phase, 3-phase	1-phase, 3-phase	
Operating voltage			20.4 - 30 V DC
Controller nominal power	350 ... 12000 VA	500 ... 9000 VA	
Fieldbus coupling	EtherCAT, EtherNet/IP, Modbus®/TCP, PROFINET	CANopen, DeviceNet, EtherCAT, EtherNet/IP, Modbus®/TCP, PROFINET, PROFIBUS DP	Ethernet
Safety function	Safe brake control (SBC), Safe torque off (STO), Safely limited speed (SLS), Safe operating stop (SOS), Safe stop 1 (SS1), Safe stop 2 (SS2), Safe maximum speed (SMS)	Safe torque off (STO), Safe stop 1 (SS1)	
Performance Level (PL)	Safe brake control (SBC)/category 3, performance level e, Safe torque off (STO)/category 4, performance level e	Safe torque off (STO)/category 4, performance level e	
Description	<ul style="list-style-type: none"> • Fits perfectly into our holistic product portfolio of electromechanical actuators, motors, drive controllers and control systems • One of the most compact servo drives on the market • Precise force, speed and position control • With the new multiprotocol variant (CMMT-...-MP) all fieldbuses (Profinet, EtherCAT®, Ethernet/IP, Modbus) are integrated in one servo drive hardware • Auto-tuning supports easy commissioning and automatically optimizes control behavior of rotary and linear motions • The latest generation of servo drive systems with optimized prices and sizes • Configure standard functional safety functions (STO, SBC) without software • Extended functional safety functions (SS1, SS2, SLS, SOS, SMS,...) can be controlled via fieldbus or I/O with guided commissioning and validation • Optimally with servo motor EMMT-AS • Universal applications • Sustainable in operation due to energy recovery 	<ul style="list-style-type: none"> • Many interfaces and functions for decentralized motion functions (flying saw, flying measurement, modulo function, etc.) • Optional: integrated cam disk controllers and highly dynamic movements • Standardized interfaces allow seamless integration in mechatronic multi-axis modular systems • Reliable and easy commissioning and parameterization with the Festo Configuration Tool (FCT) • Optionally with 3 slots for extension modules • Variants with safety functions • 255 positioning records 	<ul style="list-style-type: none"> • 6-axis low-voltage servo drive for stepper motors, open-loop, no encoder inputs • Open circuit board for integration into desktop devices (without control cabinet) • Digital interface Ethernet, USB – Positioning via G-code commands • Digital inputs for connecting the microswitches for homing
online: →	cmmt-as	cmmp	cmxl-st6





Product overview

Electric servo drives >

Stepper drive control

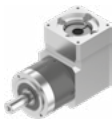

	Servo drive CMMT-ST
Nominal current load supply	8 A
Nominal voltage, load supply DC	24 V, 48 V
Fieldbus coupling	EtherCAT, EtherNet/IP, Modbus®/TCP, PROFINET
Performance Level (PL)	STO: cat. 3 PLd (EC motor without diagnostics), STO/cat. 3, PLe (stepper motor/EC motor with diagnostics)
Description	<ul style="list-style-type: none"> • Fits perfectly into our holistic product portfolio of electromechanical actuators, motors, drive controllers and control systems • Space-optimized servo drive controller for operating stepper motors, brushless DC motors (BLDC motors) and EC motors • Ideal for positioning tasks and point-to-point and interpolating movement solutions • With the new multiprotocol variant (CMMT-...-MP) all fieldbuses (Profinet, EtherCAT®, Ethernet/IP, Modbus) are integrated in one servo drive hardware • A servo drive for direct fieldbus integration to major controller manufacturers with associated function blocks • Integrated safety functions STO (SafeTorqueOff) – Cat 3, PLe / SIL 3 / SILCL 3 ensure safe operation • For highly economical applications with low power requirements of 150 W at 24 V DC, 300 W at 48 V DC and a peak power of 800W • Energy recovery and energy management ensure sustainable operation and increased efficiency • Auto-tuning makes the commissioning of rotary and linear motion even easier • High efficiency in tasks with low power requirements • 50% more compact than the smallest servo drive CMMT-AS • Ideal for use with stepper motors such as the EMMB-ST and EMMT-ST, BLDC motors and EC motors
online: →	cmmt-st

Industrial gear units

			
Gearbox EMGA-A	Gear units EMGA-P-EAS	Gear units EMGA-P-SAS	Gear units EMGA-P-SST
Gear ratio	3:1, 5:1, 8:1, 12:1, 20:1	3:1, 5:1, 8:1, 12:1, 20:1	3:1, 5:1, 8:1, 12:1
Continuous output torque	4.5 ... 120 Nm	6 ... 120 Nm	6 ... 120 Nm
Max. actuator speed	7000 ... 18000 rpm	7000 ... 18000 rpm	7000 ... 18000 rpm
Torsional rigidity	0.7 ... 5.1 Nm/arcmin	0.85 ... 10.4 Nm/arcmin	0.8 ... 10.4 Nm/arcmin
Torsional backlash	0.22 ... 0.41 deg	0.12 ... 0.31 deg	0.12 ... 0.31 deg
Mass moment of inertia, gearbox	0.032 ... 1.409 kgcm ²	0.015 ... 0.77 kgcm ²	0.015 ... 0.77 kgcm ²
Max. efficiency	92%, 93%, 94%, 95%	96%, 97%, 98%	96%, 97%, 98%
Description	<ul style="list-style-type: none"> • Bevel gear for servo motors EMME-AS, EMMT-AS, EMMS-AS • Life-time lubrication • IP54 rating 	<ul style="list-style-type: none"> • Planetary gear unit, straight, for servo motors EMME-AS, EMMT-AS • Eco AC-synchronous interface • Life-time lubrication • IP54 rating 	<ul style="list-style-type: none"> • Planetary gear unit, straight, for servo motors EMME-AS • AC-synchronous interface • Life-time lubrication • IP54 rating
online: →	emga	emga	emga

Accessories for servo drives >

Accessories for servo drives

	 Safety modules CAMC-G-S1	 Safety modules CAMC-G-S3	 Starter Kit CMMT-ST
Safety function	Safe torque off (STO)	Safe brake control (SBC), Safe speed range (SSR), Safe speed monitor (SSM), Safe torque off (STO), Safely limited speed (SLS), Safe operating stop (SOS), Safe stop 1 (SS1), Safe stop 2 (SS2)	
Safety integrity level (SIL)	Safe torque off (STO)/SIL 3/SILCL 3	Safe stop 2 (SS2)/SIL 3, Safe stop 1 (SS1)/SIL 3, Safe brake control (SBC)/SIL 3, Safely limited speed (SLS)/SIL 3, Safe operating stop (SOS)/SIL 3, Safe speed monitor (SSM)/SIL 3, Safe speed range (SSR)/SIL 3, Safe torque off (STO)/SIL 3	
Characteristics of logic input	Galvanically isolated	4 safe 2-channel inputs, equivalent/antivalent switching, test pulses configurable, function configurable, 6 safe, 1-channel inputs, test pulses configurable	
Number of digital logic inputs	2	10	
Digital output design	Floating signal contact	Floating signal contact, 3 safe, 2-channel semiconductor outputs	
Description	<ul style="list-style-type: none"> • With safety functions • For motor controller CMMP-AS-M3 • Plug-in module 	<ul style="list-style-type: none"> • With safety functions • For motor controller CMMP-AS-M3 • Plug-in module 	<ul style="list-style-type: none"> • Fits perfectly into our holistic product portfolio of electromechanical actuators, motors, drive controllers and control systems • Starter kit contents: CMMT-ST servo drive controller with multi-protocol function, EMMT-ST stepper motor and matching motor and encoder cables as one cable plug. • Simple testing: develop solutions for individual automation tasks and test possible applications in projects with the Starter Kit at a special price. • Easy to use: intuitive and simple installation with the Festo Automation Suite and use with the full range of functions.
online: →	camc	camc	cmmt-st

Product overview

Accessories for servo drives >

Power supply units



Power supply units
CACN

Nominal output voltage DC	24 ... 54 V
Nominal output current	2 ... 20 A
Input voltage range AC	100 ... 500 V
Power failure buffering	15 ... 100 ms
Description	<ul style="list-style-type: none"> • H-rail mounting • Mounting position: free convection
online: →	cacn



Product overview

Software tools

Gripper sizing



The gripper sizing application is a product selection tool that provides you with specific products for your gripper requirements.





By entering parameters such as object dimensions, surface quality and jaw length, you can find your ideal gripper system.

Configure and compare gripper solutions quickly, easily and precisely according to your specifications.

These tools can be found at www.festo.com/x/gripper-sizing





Parallel gripper

Parallel grippers

	 Parallel gripper HPPH	 Parallel gripper HEPP	 Parallel gripper HPPF	 Parallel gripper DHPL
Size	16	28, 36, 42	8, 12, 16, 20	10, 16, 20, 25, 32, 40
Stroke per gripper jaw	8 mm	15 ... 28 mm	4 ... 40 mm	10 ... 100 mm
Total gripping force at 0.6 MPa (6 bar, 87 psi), closing	278 ... 302 N		54.44 ... 346.6 N	38 ... 992 N
Maximum force on gripper jaw F_z, static	176 N	680 ... 1100 N	60 ... 320 N	40 ... 750 N
Gripping force backup	During closing		Without	Without
Pneumatic gripper repetition accuracy	0.06 mm	0.02 mm, 0.04 mm	0.02 mm, 0.03 mm, 0.06 mm	0.03 mm
Position sensing	With integrated linear potentiometer	Motor encoder	For proximity sensor	For proximity sensor
Description	<ul style="list-style-type: none"> • For safe human-robot collaboration up to 0.5 MPa • Gripper/valve combination with integrated sensors and low overall height • Reduces cycle times and saves up to 75% on compressed air compared to using individual components • TÜV certification for grippers with fingers to ISO 15066 • Can be used with many different cobots and robots thanks to the mechanical robot interface to ISO 9409-1-50-4-M6 • Gripping force backup for safe handling, even in emergency off mode • Versatile control via digital I/O (PNP/NPN) or IO-Link® • Sustainable in production due to reduction of material use • Sustainable operation thanks to integrated control 	<ul style="list-style-type: none"> • Fits perfectly into our holistic product portfolio of electromechanical actuators, motors, drive controllers and control systems • Powerful and flexible • Dynamic motor for adaptable driving behavior • Simple, variable parameterization • Compact due to integrated controller • High precision due to cross roller guide • Control via PROFINET®, EtherNet/IP®, EtherCat® • Sustainable in production due to reduction of material use 	<ul style="list-style-type: none"> • Optimal: compact and flat design • Durable: integrated guide and robust design • Economical: best price/performance ratio • Combinable: available in many sizes and strokes • Sustainable: through reduced material use and maintenance-free over the entire service life. 	<ul style="list-style-type: none"> • High torque resistance due to guided gripper jaw • Compact and sturdy design • Ideal for gripping larger parts • Double-acting piston actuator • Suitable for external and internal gripping • Mounting: direct fastening via thread, with through-hole • For position sensing with proximity sensor for T-slot and for C-slot • Sustainable in production due to reduction of material use
online: →	hpph	hepp	hppf	dhpl

Parallel gripper





Parallel grippers

	 Parallel grippers DHPS	 Parallel gripper DHPC	 Parallel grippers HGPD	 Parallel grippers HGPT-B
Size	6, 10, 16, 20, 25, 35	6, 10, 16, 20, 25, 32, 40	16, 20, 25, 35, 40, 50, 63, 80	16, 20, 25, 35, 40, 50, 63, 80
Stroke per gripper jaw	2 ... 12.5 mm	2 ... 15 mm	3 ... 20 mm	1.5 ... 25 mm
Total gripping force at 0.6 MPa (6 bar, 87 psi), closing	25 ... 910 N	7.8 ... 717.2 N	94 ... 3716 N	106 ... 6300 N
Maximum force on gripper jaw F_z, static	10 ... 450 N	22 ... 351.5 N	150 ... 6000 N	200 ... 7000 N
Gripping force backup	On opening, During closing, Without	On opening, During closing, Without	On opening, During closing, Without	On opening, During closing, Without
Pneumatic gripper repetition accuracy	0.02 mm	0.02 mm	0.03 mm, 0.04 mm, 0.05 mm	0.03 mm, 0.04 mm, 0.05 mm
Position sensing	For Hall sensor, For proximity sensor	For proximity sensor	For proximity sensor	For proximity sensor
Description	<ul style="list-style-type: none"> • Heavy-duty, precision T-slot guide for gripper jaws • High gripping force with compact size • Max. repetition accuracy • Can be used as a double-acting and single-acting gripper • Single-acting variant or with gripping force backup opening (NO) or closing (NC) • Suitable for external and internal gripping • Wide range of options for mounting on actuator units 	<ul style="list-style-type: none"> • Resilient and precise ball guide • High gripping force with compact size • Max. repetition accuracy • Can be used as a double-acting or single-acting gripper • Single-acting variant or with gripping force securing normally open (NO) or normally closed (NC) • Suitable for external and internal gripping • Wide variety of mounting and attachment options • Sustainable in production due to reduction of material use 	<ul style="list-style-type: none"> • Ideal for very harsh environments • Precise gripping even at high torque load • Max. gripping force with optimum installation space/force ratio • 8 sizes with up to 40 mm total stroke • Can be used as a double-acting and single-acting gripper • Single-acting variant or with gripping force backup opening (NO) or closing (NC) • Suitable for external and internal gripping 	<ul style="list-style-type: none"> • Sturdy and powerful • With T-slot guide • Gripper jaw guide protected by sealing air against dust • High-force variant available • Can be used as a double-acting and single-acting gripper • Single-acting variant or with gripping force backup opening (NO) or closing (NC) • Suitable for external and internal gripping
online: →	dhps	dhpc	hgpd	hgpt



Product overview

Parallel gripper

Parallel grippers

	 Parallel grippers HGPL-B	 Parallel grippers HGPP	 Parallel grippers HGPM	 Parallel grippers, electric EHPS
Size	14, 25, 40, 63	10, 12, 16, 20, 25, 32	8, 12	16, 20, 25
Stroke per gripper jaw	20 ... 150 mm	2 ... 12.5 mm	2 ... 3 mm	10 ... 16 mm
Total gripping force at 0.6 MPa (6 bar, 87 psi), closing	158 ... 2742 N	80 ... 830 N	16 ... 35 N	
Maximum force on gripper jaw F_z, static	500 ... 9000 N	40 ... 720 N	10 ... 30 N	200 ... 450 N
Gripping force backup	Without	On opening, During closing, Without	Without	
Pneumatic gripper repetition accuracy	0.03 mm	0.02 mm	0.05 mm	0.01 mm, 0.03 mm
Position sensing	For proximity sensor	For Hall sensor, For inductive proximity sensors	None	For proximity sensor, With Hall sensor, With integrated linear potentiometer, Via IO-Link interface
Description	<ul style="list-style-type: none"> • Space-saving, high forces and torques • Controlled, precise, and centered gripping • Long stroke: long guide length for the gripper jaws • Adjustability of the opening stroke for time optimization by means of stroke reduction • Double-acting gripper with two pistons operating in parallel and in opposite directions • Suitable for external and internal gripping 	<ul style="list-style-type: none"> • High-precision gripper jaw guide • Very flexible thanks to versatile attachment, mounting, and application options • Can be used as a double-acting and single-acting gripper • Single-acting variant or with gripping force backup opening (NO) or closing (NC) • Sustainable thanks to extended life cycle due to simplified reparability • Suitable for external and internal gripping 	<ul style="list-style-type: none"> • Micro gripper: compact, handy design • Versatile thanks to externally adaptable gripper fingers • Single-acting gripper, optionally with open (NO) or closed (NC) gripper jaws • Mounting options with clamping spigot, with flange mounting, with Z stroke compensation 	<ul style="list-style-type: none"> • Fits perfectly into our holistic product portfolio of electromechanical actuators, motors, drive controllers and control systems • Electrical version of the standard parallel gripper DHPS • Ideal for use as a front-end actuator thanks to its low dead weight • Controller-free actuation using digital signals • Gripping force (4-stage) adjustable via ratchet switch or via IO-Link interface • RA1 version with robot connection, enables fast integration in lightweight robot environment
online: →	hgpl	hgpp	hgpm	ehps



Three-point grippers

	 Three-point grippers DHDS	 Three-point grippers HGDD	 Three-point grippers HGDT
Size	16, 32, 50	35, 40, 50, 63, 80	25, 35, 40, 50, 63
Stroke per gripper jaw	2.5 ... 6 mm	4 ... 12 mm	1.5 ... 10 mm
Total gripping force at 0.6 MPa (6 bar, 87 psi), closing	87 ... 750 N	336 ... 2745 N	207 ... 2592 N
Gripping force backup	During closing	On opening, During closing	On opening, During closing
Pneumatic gripper repetition accuracy	0.04 mm	0.03 mm, 0.05 mm	0.03 mm
Position sensing	For Hall sensor, For proximity sensor	For proximity sensor	For proximity sensor
Description	<ul style="list-style-type: none"> • Heavy-duty, precision T-slot guide for gripper jaws • High gripping force with compact size • Max. repetition accuracy • Can be used as a double-acting and single-acting gripper • Single-acting variant or with gripping force backup normally closed (NC) • Suitable for external and internal gripping • Wide range of options for mounting on actuator units • Sustainable thanks to extended life cycle due to simplified repairability 	<ul style="list-style-type: none"> • Precise gripping with centric movements despite high torque loads • Ideal for very harsh environments • 5 sizes with up to 12 mm stroke/jaw • Can be used as a double-acting and single-acting gripper • Single-acting variant or with gripping force backup opening (NO) or closing (NC) • Suitable for external and internal gripping 	<ul style="list-style-type: none"> • Synchronous movement of the gripper jaws • Gripper jaw guide protected by sealing air against dust • High-force variant available • With T-slot guide • Can be used as a double-acting and single-acting gripper • Single-acting variant or with gripping force backup opening (NO) or closing (NC) • Suitable for external and internal gripping
online: →	dhds	hgdd	hgdt



Product overview

Angled grippers

Angle grippers

	 Angle gripper DHWC	 Angle grippers DHWS	 Angle grippers HGWM
Size	6, 10, 16, 20, 25, 32	10, 16, 25, 32, 40	8, 12
Total gripping torque at 0.6 MPa (6 bar, 87 psi), closing	5.4 ... 578.6 Ncm	30 ... 1362 Ncm	22 ... 64 Ncm
Max. opening angle	30 deg	40 deg	14 ... 18.5 deg
Gripping force backup	On opening, Without	During closing	Without
Pneumatic gripper repetition accuracy	0.1 mm	0.04 mm	0.02 mm
Position sensing	For proximity sensor	For Hall sensor, For proximity sensor	None
Description	<ul style="list-style-type: none"> • Lateral gripper jaw support for high torque loads • Max. repetition accuracy • Can be used as a double-acting or single-acting gripper • Single-acting variant with gripping force backup normally open (NO) • Suitable for external and internal gripping • Wide range of options for mounting on actuator units • Sustainable in production due to reduction of material use 	<ul style="list-style-type: none"> • Improved gripper jaw guide • Internal fixed throttling, does away with the need for external throttling in 80% of applications • Slotted guide • Max. repetition accuracy • Can be used as a double-acting and single-acting gripper • Single-acting variant or with gripping force backup normally closed (NC) • Suitable for external and internal gripping • Wide range of options for mounting on actuator units 	<ul style="list-style-type: none"> • Micro gripper: compact, handy design • Versatile thanks to externally adaptable gripper fingers • Single-acting gripper, optionally with open (NO) or closed (NC) gripper jaws • Suitable for external and internal gripping • Mounting options with clamping spigot, with flange mounting, with Z stroke compensation
online: →	dhwc	dhws	hgwm



Radial grippers

	 Radial gripper DHRC	 Radial grippers DHRS	 Radial grippers HGRT
Size	6, 10, 16, 20, 25, 32	10, 16, 25, 32, 40	16, 20, 25, 32, 40, 50
Total gripping torque at 0.6 MPa (6 bar, 87 psi), closing	4.8 ... 600.1 Ncm	15 ... 660 Ncm	158 ... 7754 Ncm
Max. opening angle	180 deg	180 deg	180 deg
Gripping force backup	On opening, Without	During closing	During closing
Pneumatic gripper repetition accuracy	0.1 mm	0.1 mm	0.02 mm
Position sensing	For proximity sensor	For Hall sensor, For proximity sensor	For proximity sensor, For inductive proximity sensors
Description	<ul style="list-style-type: none"> • Lateral gripper jaw support for high torque loads • Can be used as a double-acting or single-acting gripper • Single-acting variant with gripping force backup normally open (NO) • Suitable for external and internal gripping • Wide range of options for mounting on actuator units • Sustainable in production due to reduction of material use 	<ul style="list-style-type: none"> • Lateral gripper jaw support for high torque loads • Self-centering • Internal fixed throttling • Max. repetition accuracy • Slotted guide • Can be used as a double-acting and single-acting gripper • Single-acting variant or with gripping force backup normally closed (NC) • Wide range of options for mounting on actuator units 	<ul style="list-style-type: none"> • Robust and precise kinematics for the highest torque resistance and long service life • Secure gripping thanks to precise, polished plain-bearing guides • Slotted guide • Optimum cycle times thanks to freely adjustable opening angle up to a maximum of 90° per gripper finger. This prevents the possibility of collisions due to the gripper jaws opening too wide • Can be used as a double-acting and single-acting gripper • Single-acting variant or with gripping force backup normally closed (NC) • Suitable for external and internal gripping • Wide range of options for mounting on actuator units
online: →	dhrc	dhrs	hgrr

Product overview



Swivel gripping units

Swivel/gripper units

	 Swivel/gripper units HGDS	 Rotary gripper modules EHMD
Design	Quarter turn actuator, with parallel gripper and gripper actuator	Electric rotary actuator, Electric gripper, Pneumatic gripper
Size	12, 16, 20	40, 50
Total gripping force at 0.6 MPa (6 bar, 87 psi), closing	74 ... 168 N	
Stroke per gripper jaw	2.5 ... 7 mm	5 ... 15 mm
Swivel angle	210 deg	
Position sensing, pneumatic gripper	With proximity sensor	
Description	<ul style="list-style-type: none"> • Combination of parallel gripper and swivel module • Swivel angle infinitely adjustable • Precise end stop with elastic cushioning or integrated shock absorber 	<ul style="list-style-type: none"> • Fits perfectly into our holistic product portfolio of electromechanical actuators, motors, drive controllers and control systems • Ideal for small objects in laboratory automation • Infinite electric rotation and electric or pneumatic gripping • Gripping and turning to open and close covers on vials • Optional: fastening with Z-compensation compensates the thread pitch of covers on vials during opening and closing
online: →	hgds	ehmd



Bellows gripper

Bellows grippers

	 Soft gripper HPSX	 Adaptive shape gripper DHEF	 Bellows grippers DHEB
Size	40, 70, 100	20	8, 10, 12, 14, 18, 22, 27, 33, 41, 51, 63
Stroke		66 mm	
Stroke of bellows			3.5 ... 25 mm
Max. operating frequency of pneumatic gripper	5 Hz	1 Hz	≤4 Hz
Min. diameter to be gripped	30 ... 80 mm	12 mm	8 ... 66 mm
Max. diameter to be gripped	55 ... 110 mm	38 mm	11 ... 85 mm
Position sensing		For proximity sensor	For proximity sensor, None
Description	<ul style="list-style-type: none"> • Suitable for direct food contact according to European Regulation (EC) No. 1935/2004 • Gentle gripping of sensitive objects thanks to soft fingers • Less machine downtime, servicing and cleaning work thanks to clean design and simple installation • Flexible gripper due to different sizes and number of gripper fingers • Collaborative: Suitable for use on cobots and industrial robots thanks to its soft design • Simple and quick setup thanks to ISO-standardized interface ISO50 with defined positioning 	<ul style="list-style-type: none"> • Gripping of parts with undefined positions and shapes • Form-fitting gripping of products with different geometries • Form-fitting gripping with suction cup effect • Gentle gripping of delicate products of varying sizes • RA1 version with robot connection, enables fast integration in lightweight robot environment • Sustainable thanks to extended life cycle due to simplified reparability 	<ul style="list-style-type: none"> • 11 sizes for gripping diameter from 8 to 85 mm • Direction of movement: bellows upwards or downwards • Different bellows materials: EPDM or silicone • Air connection on the side or from above • Optimized process sequence with increased quality: prevents the workpieces from being scratched • Additional reliability: optional sensing via proximity or position sensor • For gentle internal gripping of delicate workpieces
online: →	hpsx	dhef	dheb

Accessories for grippers

Accessories for pneumatic grippers

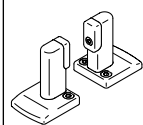
	 Adaptive gripper fingers DHAS-GF	 Gripper jaw DHAS-GG	 Gripper finger HAFH
Size	60, 80, 120	16 mm	16
Description	<ul style="list-style-type: none"> • Self-adapting to different workpiece shapes • Adaptive gripper fingers for gentle and flexible gripping, using the Fin Ray Effect® modelled on a fish tail fin • For workpiece diameters from 6 to 120 mm 	<ul style="list-style-type: none"> • Process-reliable gripping for microtiter plates in the life sciences sector • Easy assembly 	<ul style="list-style-type: none"> • Suitable for human-robot collaboration to ISO 15066 • Easy replacement of the gripper finger pads in the event of wear • Can be mounted on pneumatic gripper/valve combination HPPH
online: →	dhas	dhas	hafh

Product overview

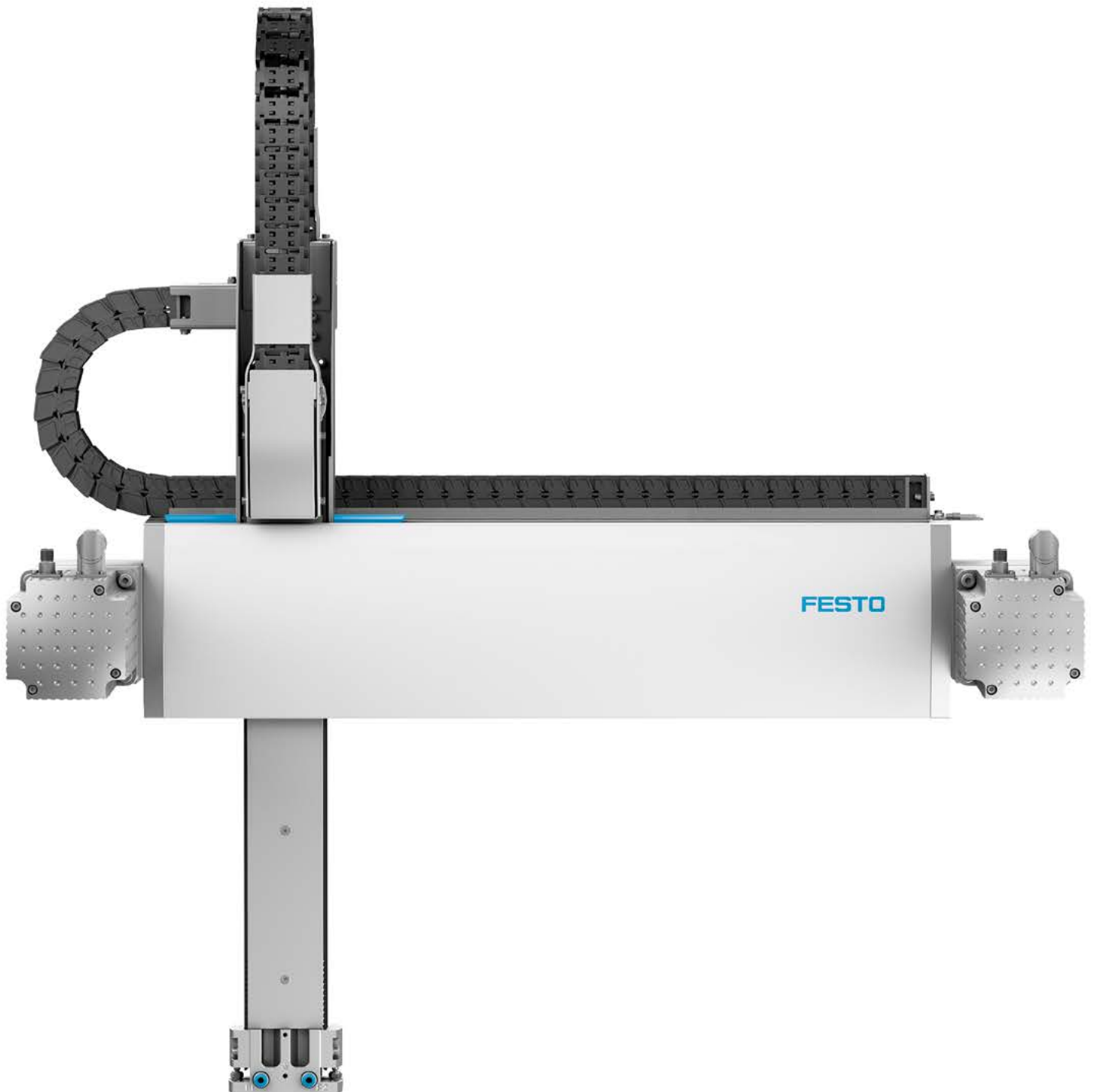

06

Grippers





Product overview

Pneumatic handling systems



	 Handling modules HSP	 Handling modules, pneumatic HSW-AP, HSW-AS
Size	12, 16, 25	10, 12, 16
Y-stroke	52 ... 170 mm	
Z-stroke	20 ... 70 mm	80 ... 100 mm
Repetition accuracy	+/-0.01 mm, +/-0.02 mm	
Min. cycle time	0.6 ... 1 s	0.6 ... 1 s
Theoretical force at 0.6 MPa (6 bar, 87 psi)	40 ... 65 N	30 ... 55 N
Description	<ul style="list-style-type: none"> • Function module for the automatic transfer, feeding, and removal of small parts in extremely confined spaces • Guided vertical and horizontal motion sequence • High precision and good rigidity • Compact design • Extremely short cycle times • Cost-optimized • Stroke adjustment along Y- and Z-axes 	<ul style="list-style-type: none"> • Function module for the automatic transfer, feeding, and removal of small parts in extremely confined spaces • Guided swivel and linear motion • High precision and good rigidity • HSW-AP: pneumatic, with swivel module DSM; HSW-AS: without actuator, with actuator shaft • Fast and compact • Low-cost and ideal for universal use
online: →	hsp	hsw

Software tools

<p>Configurator</p> 	<p>Design a product with numerous characteristics reliably and quickly with the help of the configurator.</p> <p>Select all the required product characteristics step-by-step. The use of logic checks ensures that only correct configurations are available for selection.</p> <p>You can find the configurator for your desired product</p> <ul style="list-style-type: none"> • at www.festo.com/catalogue/handling • choose your desired product • click on the blue „Configure product“ button
<p>Handling Guide Online</p> 	<p>Planning and designing complex handling systems, e.g. for pick & place applications, generally takes a lot of time.</p> <p>The innovative Handling Guide Online (HGO) allows you to design a customized system in just a few steps. Simply enter your application data such as the load mass, travel path and cycle time.</p> <p>Advantages:</p> <ul style="list-style-type: none"> • 1D- ... 3D kinematics • Customized system solutions within just a few minutes • CAD model available instantly • Fully automatic selection of all relevant components • Fully automated processing including ordering function • Fully assembled or unassembled systems <p>You can find this tool at</p> <p>→ www.festo.com/x/handling-guide-online</p>



Cartesian robots >

Linear gantries

	 Linear gantry, highly dynamic YXML	 Two-dimensional linear gantries YXCL	 Two axis robots EXCT
Description	<ul style="list-style-type: none"> • Fits perfectly into our holistic product portfolio of electromechanical actuators, motors, drive controllers and control systems • Parallel kinematic actuating concept for high dynamic response • Ready-to-install complete system, including energy chain for cables and tubing as well as matching motor and servo drive package • Flexible working space due to scalable strokes in the Y and Z direction • Based on linear gantry EXCT • Optimum dynamic response with up to 95 picks/min • For rapid processes with high cycle rates like pick & place, feeding parts, stacking, packaging tasks 	<ul style="list-style-type: none"> • Fits perfectly into our holistic product portfolio of electromechanical actuators, motors, drive controllers and control systems • Ready-to-install complete system, including energy chain for cables and tubing as well as matching motor and servo drive package • For two-dimensional movements in a vertical working space • Flexible working space due to scalable strokes in the Y and Z direction • Serial kinematic drive concept based on toothed belt and spindle axes • Choice of vertical axis – pneumatic or electric • High mechanical rigidity and sturdy design • Ideal for long gantry strokes and heavy loads 	<ul style="list-style-type: none"> • Axis mechanism based on parallel kinematic operational principle • Very high dynamics enable extremely short cycle times • For two-dimensional movements in a vertical working space • Flat system design and low moving dead weight • The motor can be flexibly mounted on 4 sides
online: →	yxml	yxcl	exct

Cartesian robots >



Planar surface gantries

	 Planar surface gantry, compact YXMF	 Planar surface gantry, highly dynamic YXMF	 Two-dimensional planar surface gantries YXCF
Description	<ul style="list-style-type: none"> • Parallel kinematic actuating concept with minimal space requirements • Ready-to-install complete system including energy chain and matching motors and double servo drive • For two-dimensional movements in the horizontal working space • Flexible working space through scalable strokes in the Y and Z direction • Based on the planar surface gantry EXCM • For extremely small working spaces • For desktop applications in small parts assembly, electronics manufacturing and laboratory processes 	<ul style="list-style-type: none"> • Parallel kinematic actuating concept for high dynamic response • Ready-to-install complete system, including energy chain and matching motor and servo drive package • For two-dimensional movements in the horizontal working space • Flexible working space through scalable strokes in the Y and Z direction • Based on the planar surface gantry EXCH • Optimum dynamic response and efficient operation with up to 100 picks/min • For rapid processes with high cycle rates like pick & place, feeding parts, stacking, packaging tasks • Cost-effective alternative to two Scara robots due to large working space and high dynamic response 	<ul style="list-style-type: none"> • Fits perfectly into our holistic product portfolio of electromechanical actuators, motors, drive controllers and control systems • Ready-to-install complete system, including energy chain for cables and tubing as well as matching motor and servo drive package • For two-dimensional movements in the horizontal working space • Serial kinematic drive concept based on toothed belt and spindle axes • Flexible working space through scalable strokes in the Y and Z direction • Particularly suitable for very long strokes and heavy payloads
online: →	yxmf	yxmf	yxcf

Product overview



Cartesian robots >

Planar surface gantries

		
	Two-dimensional planar surface gantries EXCM	Two-dimensional planar surface gantries EXCH
Description	<ul style="list-style-type: none"> • Fits perfectly into our holistic product portfolio of electromechanical actuators, motors, drive controllers and control systems • Axis mechanism based on parallel kinematic operational principle • Excellent functionality in confined spaces • Low moving dead weight and flat system design • Ideal in combination with stepper motors • With ball bearing guide • Sustainable operation due to weight-optimized axes 	<ul style="list-style-type: none"> • Fits perfectly into our holistic product portfolio of electromechanical actuators, motors, drive controllers and control systems • Axis mechanism based on parallel kinematic operational principle • Optimal dynamic response when compared with other Cartesian gantry systems • Actuator concept with limited moving dead weight and large workspace • High accelerations in both axis directions in combination with servo motors • Sustainable operation due to weight-optimized axes • The motor can be flexibly mounted on 2 sides
online: →	excm	exch

Cartesian robots >

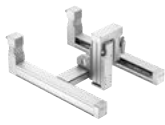
Three-dimensional gantries

				
	Three-dimensional gantries EXCL	3-dimensional gantry, compact YXMR	3-dimensional gantry, highly dynamic YXMR	Three-dimensional gantries YXCR
Description	<ul style="list-style-type: none"> • Fits perfectly into our holistic product portfolio of electromechanical actuators, motors, drive controllers and control systems • Multi-axis gantry with small footprint • with one or 2 Z-axes (or as a planar surface gantry X/Y without Z-axes) • X, Y workspace configurable in 1 mm increments up to 1000 mm x 700 mm • Z-axis stroke can be selected between 50, 100, 150 and 200 mm • Optional 6-axis motion controller, programmable via G-code • included: stepper motors, reference switches and cables always included 	<ul style="list-style-type: none"> • Parallel kinematic actuating concept with minimal space requirements • Ready-to-install complete system including energy chain and matching motors and double servo drive • For three-dimensional movements in horizontal working spaces • Flexible working space through scalable strokes in the Y and Z direction • Based on the planar surface gantry EXCM • Choice of vertical axis – pneumatic or electric • For extremely small working spaces • For desktop applications in small parts assembly, electronics manufacturing and laboratory processes 	<ul style="list-style-type: none"> • Parallel kinematic actuating concept for high dynamic response • Ready-to-install complete system, including energy chain and matching motor and servo drive package • For three-dimensional movements in horizontal working spaces • Flexible working space due to scalable strokes in the Y and Z direction • Based on the planar surface gantry EXCH • Optimum dynamic response and efficient operation with up to 100 picks/min • Choice of vertical axis – pneumatic or electric • For rapid processes with high cycle rates like mounting, packaging and sorting 	<ul style="list-style-type: none"> • Ready-to-install complete system, including energy chain for cables and tubing as well as matching motor and servo drive package • For three-dimensional movements in horizontal working spaces • Flexible working space due to scaleable strokes along the Y- and Z-axes • Serial kinematic drive concept based on toothed belt and spindle axes • Choice of vertical axis – pneumatic or electric • High mechanical rigidity and sturdy design • Universal applications • Especially suitable for very long strokes in every direction
online: →	excl	yxmr	yxmr	yxcr



Cartesian robots >

3D cantilever systems

	 <p>Cantilever system YXCA</p>
Description	<ul style="list-style-type: none"> • Fits perfectly into our holistic product portfolio of electromechanical actuators, motors, drive controllers and control systems • Extremely space-saving 3D system with attractive price-performance ratio • Self-supporting Y-axis enables freely accessible working area with few interfering contours • Pneumatic and electric components can be freely combined • For horizontal mounting position • For simple assembly tasks and small parts handling in the electrical industry • Ideal for use in line assembly processes or desktop application
online: →	yxca

Proportioning- and pipetting heads

Dispense heads

	 <p>Dispense heads VTOE</p>		 <p>Dispense heads VTOI</p>
Description	<ul style="list-style-type: none"> • Basic function: dosing • Ready-to-install dosing solution saves time and costs • Compact 9 mm width dimension • Suitable for sensitive and aggressive liquids • Ideally suited to non-contact dosing of liquid media • Maximum dosing precision down to the microliter range • Small internal volume makes it easy to rinse • 1 or 8-channel dispense head • Typical coefficient variation (CV): < 1% at 10 to 1000 µl 		<ul style="list-style-type: none"> • One valve control for distribution into 8 dispensing channels • Grid size 9 mm – ideal for microwell plates • Simple design with side-by-side mounting for increased throughput • Just a few components needed for a complete system • Suitable for aggressive liquids
online: →	vtoe		vtoi

Product overview

Control cabinets



Control systems
CMCB

Design	Mounting plate, Control cabinet, Integrated safety relay unit
Electrical connection	Spring-loaded terminal, Push-in
Mains frequency	50 ... 60 Hz
Performance Level (PL)	Category B, performance level b, Category 3, performance level d
Description	<ul style="list-style-type: none"> • Ready-to-install control system • Available on a mounting plate with or without control cabinet housing • Variants with safety functions • Tailored to balancer kit YHBP • With connected connecting cables for the balancer kit YHBP
online: →	cmcb

Customized components – for your specific requirements

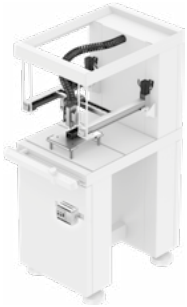

Compact handling system for desktop applications

- Modular system kit comprising operating software and planar surface gantry EXCM-30
- Quick and easy programming and commissioning using the predefined function elements from the Positioning Desktop Lib
- One basic platform for a wide range of applications (screwing, dispensing, testing, soldering, gripping, machine vision and much more)
- Predefined function elements from the software library make for easy programming and commissioning
- Easy integration, even in the most compact of installation spaces
- Fit for Industry 4.0 thanks to the OPC UA interface at the controller

Many additional variants are possible.

Ask your Festo sales engineer, who will be happy to help:

→ www.festo.com/contact



Product overview

Software tools





Vacuum design





Which suction cup is used for which surface and which movement?
 Don't experiment – calculate!
 The vacuum selection program helps you select the right vacuum cups, tubing and venturi nozzles. It also calculates the distribution of the forces acting on the individual vacuum cups, as well as the evacuation time.
 This software tool even enables a distinction to be made between linear and rotary movements.

This tool can be found at
www.festo.com/x/vacuum-sizing



Vacuum generators

	 Vacuum generator OVEH	 Vacuum generators OVTL	 Vacuum generators OVEL	 Vacuum generators OVEM
Nominal width of Laval nozzle	0.7 ... 0.95 mm	0.45 ... 0.95 mm	0.45 ... 0.95 mm	0.45 ... 3 mm
Ejector characteristics	High suction rate, High vacuum, Standard	High suction rate, High vacuum, Standard	High suction rate, High vacuum, Standard	High suction rate, High vacuum, Standard
Integrated function	Electric ejector pulse, Pressure sensor, On/off valve, electric, Filter, Muffler, closed	Electric ejector pulse, Flow control, Pressure sensor, Pressure transmitter, On/off valve, electric, Filter, Pneumatic muffler open	Electric ejector pulse, Flow control, Pressure sensor, Pressure transmitter, On/off valve, electric, Filter, Pneumatic muffler open, Muffler, closed	Ejector pulse valve, electric, Flow control, On/off valve, electric, Filter, Air saving function, electrical, Non-return valve, Pneumatic muffler open, Vacuum switch
Max. suction rate with respect to atmosphere	15 ... 30 l/min	4 ... 45 l/min	4 ... 21 l/min	6 ... 348 l/min
Description	<ul style="list-style-type: none"> • Compact vacuum generator/valve combination with integrated sensors • Can be used with many different cobots and robots thanks to the mechanical robot interface to ISO 9409-1-50-4-M6 • Vacuum level monitoring with integrated pressure sensor SPAE • Versatile control via digital I/O (PNP/NPN) or IO-Link® • Valve-controlled ejector impulse for safe handling • For applications with either high vacuum or high suction flow rate • Adapter plate for different applications • For safe human-robot collaboration 	<ul style="list-style-type: none"> • Module consisting of vacuum generator OVEL, terminal strip and accessories • Select, size and order easily, quickly and reliably via the configurator • Supplied fully assembled 	<ul style="list-style-type: none"> • Low-cost, compact vacuum generator • Light weight • Various performance levels and vacuum types • Short switching times thanks to integrated air solenoid valves • Quick, precise and safe placement of the workpiece via the ejector pulse • Easy assembly • Minimal installation costs • Sustainable in operation due to reduction of the pressure level • RA1 version with robot connection, enables fast integration in lightweight robot environment 	<ul style="list-style-type: none"> • Compact design • Monitoring with vacuum sensor with IO-Link® • Central electrical connection via an M12 plug • Maintenance-free operation and reduced noise level through an integrated, open muffler • Integrated compressed air filter with inspection window • With optional air-saving function and LCD display • Short switching times thanks to integrated air solenoid valves • Adjustable ejector pulse: precise and safe depositing of the workpiece • Sustainable in operation due to the use of an air-saving circuit
online: →	oveh	ovtl	ovel	ovem

Vacuum generators





	 Vacuum generators, NPT OVEM	 Vacuum generator OVPN	 Vacuum generators, pneumatic VN
Nominal width of Laval nozzle	0.45 ... 1.4 mm	1.4 ... 2.6 mm	0.45 ... 3 mm
Ejector characteristics	High suction rate, High vacuum, Standard	High suction rate	High suction rate, High vacuum, Standard, Inline, High negative pressure, High suction volume
Integrated function	Ejector pulse valve, electric, Flow control, On/off valve, electric, Filter, Air saving function, electrical, Non-return valve, Pneumatic muffler open, Vacuum switch	Pneumatic muffler open	Ejector pulse valve, pneumatic, Pressure sensor, Pneumatic muffler open
Max. suction rate with respect to atmosphere	50.5 l/min	160 ... 960 l/min	6.1 ... 339 l/min
Description	<ul style="list-style-type: none"> Monitoring with vacuum sensor with IO-Link® Central electrical connection via an M12 plug Maintenance-free operation and reduced noise level through an integrated, open muffler Integrated compressed air filter with inspection window With optional air-saving function and LCD display Adjustable ejector pulse: precise and safe depositing of the workpiece 	<ul style="list-style-type: none"> Vacuum generator with very high suction capacity ideal for porous materials Nozzle technology with maximum energy efficiency High initial suction volume flow Reduced sound pressure level due to integrated, open silencer Flexible use for centralized or decentralized vacuum generation Extra light Sustainable operation thanks to optimized air consumption 	<ul style="list-style-type: none"> Can be used directly in the work space Available as a straight type (inline: vacuum port in line with the supply port) or T-shape (standard: vacuum port at 90° to the supply port) Compact and cost-effective Maintenance-free operation and reduced noise level through an integrated, open muffler Variants recommended for production facilities for the manufacture of lithium-ion batteries
online: →	ovem	ovpn	vn

Vacuum generators



	 Vacuum generators, electropneumatic VN	 Vacuum generators for valve manifolds CPV CPV10-M1H, CPV14-M1H, CPV18-M1H	 Vacuum generator cartridges VN
Nominal width of Laval nozzle	0.45 ... 3 mm	0.7 ... 1.4 mm	0.45 ... 2 mm
Ejector characteristics	Standard, High negative pressure, High suction volume	High vacuum	Standard, High negative pressure, High suction volume
Integrated function	Ejector pulse valve, pneumatic, On/off valve, electric, Pneumatic muffler open		
Max. suction rate with respect to atmosphere	7.2 ... 186 l/min		7.2 ... 184.4 l/min
Description	<ul style="list-style-type: none"> Can be used directly in the work space Cost-effective Maintenance-free operation and reduced noise level through an integrated, open muffler With solenoid valve vacuum shut-off 	<ul style="list-style-type: none"> Combinations of switching valves with vacuum generators are possible on a valve manifold With solenoid valve vacuum shut-off With optional ejector pulse 	<ul style="list-style-type: none"> For fitting into customized housing for decentralized vacuum generation
online: →	vn	cpv10-m1h	vn

Product overview

Vacuum suction cups

	 Vacuum suction cup OGVM	 Bernoulli grippers OGGB	 Suction grippers ESG	 Vacuum cups ESS
Vacuum cup size	16x55 mm, 20x60 mm, 20x65 mm, 30x65 mm, 30x80 mm, 30x95 mm, 40x85 mm, 40x90 mm, 50x105 mm, 55x115 mm, 60x125 mm, 70x145 mm, 20x60 mm		4x20 mm, 6x10 mm, 6x20 mm, 8x20 mm, 8x30 mm, 4x10 mm, 10x30 mm, 15x45 mm, 20x60 mm, 25x75 mm, 30x90 mm	4x20 mm, 6x10 mm, 6x20 mm, 8x20 mm, 8x30 mm, 4x10 mm, 10x30 mm, 15x45 mm, 20x60 mm, 25x75 mm, 30x90 mm
Pneumatic gripper diameter		60 ... 140 mm		
Vacuum cup diameter	20 ... 125 mm		2 ... 200 mm	2 ... 200 mm
Holding force at nominal operating pressure	15 ... 630 N	6 ... 10 N		0.1 ... 1610 N
Design			Vacuum connection at top, Vacuum connection at side, with height compensation, with long height compensation	Round, bell-shaped
Information on vacuum cup materials	NBR		BR, FPM, NBR, PUR, VMQ (silicone), Vulkollan®	FPM, NBR, PUR, VMQ (silicone), Vulkollan®
Spacer element material		NBR, POM		
Description	<ul style="list-style-type: none"> Highly energy efficient, highest transverse loads, minimal intake times Optimum suction ergonomics for maximum process reliability Ideal for workpieces with complex contours Accessories available for a wide range of applications Suction cup shape round or oval, in various designs 	<ul style="list-style-type: none"> Ideally suited to transporting thin, extremely delicate and brittle workpieces Minimized workpiece contact, gentle workpiece handling Low energy costs thanks to minimized air consumption The ideal solution for minimal contact gripping and for gripping pliable, porous and brittle workpieces 	<ul style="list-style-type: none"> Modular system of suction cup holders and suction cups with over 2000 variants With optional angle compensator, height compensator, compressed air filter Suction cup shape round or oval, in various designs 6 suction cup designs 15 suction cup diameters Suction cup volume: 0.002 ... 245 cm³ Min. workpiece radius: 10 ... 680 mm Vacuum port: push-in connector or barbed fitting for plastic tubing, threaded connection 	<ul style="list-style-type: none"> Suction cup consisting of the suction cup itself, plus the support plate with mounting Suction cup volume: 0.002 ... 245 cm³ Min. workpiece radius: 10 ... 680 mm Mounting for suction cup holder: internal thread, external thread, push-in connector Vacuum suction cup with mounting thread
online: →	ogvm	oggb	esg	ess

Vacuum suction cups

	 Vacuum cups ESV	 Vacuum cups VAS, VASB	 Suction cup with connection OGVN
Vacuum cup size			
Pneumatic gripper diameter			
Vacuum cup diameter	20 ... 200 mm	2 ... 125 mm	20 ... 75 mm
Holding force at nominal operating pressure	8.2 ... 1610 N	0.14 ... 700 N	14.5 ... 173 N
Design	Bellows, Round, bell-shaped		
Information on vacuum cup materials	FPM, NBR, PUR, VMQ (silicone), Vulkollan®	NBR, PUR, TPE-U(PU), VMQ (silicone)	PUR
Spacer element material			
Description	<ul style="list-style-type: none"> • Wearing part for assembled suction cup ESS • Easily interchangeable • Suction cup volume: 0.318 ... 245 cm³ • Min. workpiece radius: 10 ... 680 mm 	<ul style="list-style-type: none"> • Sturdy and reliable • Suction cups with fixed connecting thread • 11 suction cup diameters • Round suction cup shape, bellows • Vacuum port on top, on the side • Screw-in thread • Variants suitable for battery production according to F1A 	<ul style="list-style-type: none"> • Ideal for workpieces with uneven surfaces • Simple, tool-free replacement of the suction cup material • Made from wear-resistant polyurethane • Easy mounting even with limited installation space thanks to hexagon socket • Recommended for production plants for manufacturing lithium-ion batteries, F1A
online: →	esv	vas	ogvn

Accessories for vacuum >





Assembly and connecting components

	 Vacuum cup holders ESH
Design	Vacuum connection at top, Vacuum connection at side, with height compensation
Description	<ul style="list-style-type: none"> • With or without height compensator • 6 holder sizes • 8 holder types • 3 different types of vacuum connections: push-in connection, push-in nipple connection, threaded connection
online: →	esh

Product overview





Accessories for vacuum >

Vacuum-specific accessories

	 Inline filter Oafa	 Length compensator Val	 Angle compensators Eswa	 Vacuum gauges Vam, Fvam
Vacuum connection		Female thread G1/8, Female thread G1/4, Internal thread G3/8, Internal thread M5		
Pneumatic connection	For pneumatic tubing outside diameter 4 mm, For pneumatic tubing outside diameter 6 mm, For pneumatic tubing outside diameter 8 mm		M10, M4, M6	G1/4, G1/8, R1/4, R1/8
Type of mounting	Line installation	With external thread M16x1, With external thread M22x1.5, With external thread M25x1.5, With external thread M26x1.5	With external thread	Front panel mounting, Screw-in
Grade of filtration	10 µm, 40 µm			
Description	<ul style="list-style-type: none"> • Inline filters for overpressure and vacuum applications • For tubing connections in various sizes • Filter fineness: optionally 10 or 40 µm • Transparent housing to determine the contamination level • Replaceable filter element • Recommended for production plants for manufacturing lithium-ion batteries, F1A • Optional: Mounting component OAMM 	<ul style="list-style-type: none"> • For suction cup VAS/VASB • Vacuum port M5, G1/8, G1/4 • To compensate for a possible excess stroke of the handling device • To compensate for tolerance differences in the workpiece thickness • Variants suitable for battery production according to F1A 	<ul style="list-style-type: none"> • For suction gripper ESG • Vacuum port M4x0.7, M6x1, M10x1.5 • For mounting between suction cup complete holder and suction cup with connection 	<ul style="list-style-type: none"> • Designs based on DIN EN 837-1, with optional red-green range • Pneumatic connection via R or G thread • Double or single scale • Display units bar, in Hg, psi
online: →	oafa	val	eswa	vam

Accessories for vacuum >

Vacuum-specific accessories

	 Vacuum filter ESF, VAF, OAFF	 Vacuum security valves ISV	 Mufflers UO	 Mufflers UOM, UOMS
Vacuum connection	M4, M6, G1/4, G3/8, G1/2			
Pneumatic connection	G1/2, G1/4, G3/8, M4, M6, PK-3 Via union nut, PK-4 Via union nut, PK-6 Via union nut		G1/4, G1/8, M5, M7	G1/4, G3/8
Type of mounting	Line installation, Push-on, Engaging, With external thread, With wall/surface bracket, Via vacuum connection	Screw-in		Engaging, Screw-in
Grade of filtration	10 µm, 40 µm, 50 µm, 80 µm			
Description	<ul style="list-style-type: none"> • Vacuum filter ESF: for suction gripper ESG • Vacuum filter VAF: with transparent housing or bowl to allow users to assess contamination level • Vacuum filter OAFF: for vacuum generators OVEL 	<ul style="list-style-type: none"> • For maintaining the vacuum when using multiple suction cups and one fails • Gripping of randomly placed products • Saves compressed air and energy • Variants suitable for battery production according to F1A 	<ul style="list-style-type: none"> • Special open minimal resistance muffler • For vacuum generators • Facilitates trouble-free operation of the vacuum generator • Operating medium: compressed air 	<ul style="list-style-type: none"> • Special open minimal resistance muffler • For vacuum generators • Facilitates trouble-free operation of the vacuum generator • Muffler extension for extending the muffler for further noise reduction • Operating medium: compressed air
online: →	vaf	isv	uo	uom

Product overview



Product overview

Software tools

Pneumatic sizing







Dimension pneumatic control loop systems quickly and energy-efficiently. In order to survive in a fiercely competitive environment, many companies are looking for potential savings in their production.

They also find these in their compressed air systems and equipment, most of which have been in place for years. Up to 60% energy costs can be saved here through optimization at the hall and plant level.

This tool can be found at
→ www.festo.com/x/pneumatic-sizing

Electrically and pneumatically actuated directional control valves >





Standards-based directional control valves

	 Solenoid valves VSNC	 Solenoid valves VSNC-G1/8	 Standards-based valves with central plug VSVA-R5, VSVA-R2	 Standards-based valves with individual plug VSVA-C1, VSVA-P1
Actuation type	Electrical	Electrical	Electrical	Electrical
Pneumatic connection 1	1/4 NPT, G1/4, QS-1/4, QS-10, QS-3/8, QS-5/16, QS-6, QS-8	G1/8	Sub-base Size 1 ISO 5599-1, Size 2 ISO 5599-1	Sub-base Size 1 ISO 5599-1, Size 18 ISO 15407-1, Size 26 ISO 15407-1
Operating pressure [MPa]	0.15 ... 1 MPa	0.25 ... 0.8 MPa	-0.09 ... 1.6 MPa	-0.09 ... 1.6 MPa
Operating pressure	1.5 ... 10 bar	2.5 ... 8 bar	-0.9 ... 16 bar	-0.9 ... 16 bar
Standard nominal flow rate	800 ... 1350 l/min	400 l/min	400 ... 2800 l/min	400 ... 1400 l/min
Valve function	5/2, bistable, 5/2 or 3/2 switchable, 5/3, pressurized, 5/3, exhausted, 5/3, closed	3/2, closed, monostable, 5/2, monostable, Connections exchanged	2x2/2 closed, monostable, 2x3/2, closed, monostable, 2x3/2, open, monostable, 2x3/2, open/closed, monostable, 5/2, bistable, 5/2, bistable, dominant, 5/2, monostable, 5/3, pressurized, 5/3, exhausted, 5/3, closed	2x2/2 closed, monostable, 2x3/2, closed, monostable, 2x3/2, open, monostable, 2x3/2, open/closed, monostable, 5/2, bistable, 5/2, bistable, dominant, 5/2, monostable, 5/3, pressurized, 5/3, exhausted, 5/3, closed
Electrical connection	3-pin, Form A, Form B, Cable connector M20x1.5, M12x1, A-coded as per EN 61076-2-101, Plug, as per EN 175301-803, As per industrial standard (11 mm)	Form C	3-pin, 4-pin, Central plug, Round design, M8x1, M12x1	Form B, Form C, With PE conductor, as per DIN EN 175301-803, as per EN 175301-803, As per industrial standard (11 mm), Without PE conductor
Description	<ul style="list-style-type: none"> NAMUR port pattern for solenoid valves to VDI/VDE 3845 Rotatable seal for 3/2- or 5/2-way valve Wide choice of EX solenoid systems Sturdy and powerful Extended temperature range Outstanding value for money All solenoid coils can be used on an armature tube The VSNC-...FN variant achieves greater industrial energy efficiency with reduced power consumption 	<ul style="list-style-type: none"> NAMUR port pattern for solenoid valves to VDI/VDE 3845 Compact, cost-effective, powerful Especially suitable for rotary actuators DAPS and DFPD with plug pattern according to VDI/VDE 3845 Extended temperature range Electrical connection with plug pattern form C, according to EN 175301-803 Solenoid coil 24 V integrated Outstanding value for money 	<ul style="list-style-type: none"> Corresponds to ISO 5599-1 Electrical connection via central plug Robust metal housing Manifold assembly with mixed sizes possible 	<ul style="list-style-type: none"> Corresponds to ISO 15407-1 and to ISO 15218 for pilot valve with interface Electrical connection via type C plug Robust metal housing Manifold assembly with mixed sizes possible
online: →	vsnc	vsnc	vsva	vsva

Product overview



Electrically and pneumatically actuated directional control valves >

Standards-based directional control valves

	 Standards-based valves, plug-in VSVA-T1	 Pneumatic valves, to ISO 15407-1 VSPA	 Solenoid valves, to ISO 5599-1 MN1H, MFH, MDH, MEBH, JMN1H, JMN1DH, JMFH, JMFHDH, JMDH, JMEBH, JMEBDH, JMDDH	 Pneumatic valves, to ISO 5599-1 VL, J, JD
Actuation type	Electrical	Pneumatic	Electrical	Pneumatic
Pneumatic connection 1	Sub-base Size 1 ISO 5599-2, Size 2 ISO 5599-2, Size 18 ISO 15407-2, Size 26 ISO 15407-2	Sub-base Size 18 ISO 15407-1, Size 26 ISO 15407-1	Sub-base, size 3 as per ISO 5599-1, Sub-base Size 1 ISO 5599-1, Size 2 ISO 5599-1, Size 3 ISO 5599-1, Size 4 ISO 5599-1	Sub-base, size 1 as per ISO 5599-1, Sub-base, size 2 as per ISO 5599-1, Sub-base Size 3 ISO 5599-1, Size 4 ISO 5599-1
Operating pressure [MPa]	-0.09 ... 1 MPa		-0.09 ... 1.6 MPa	-0.09 ... 1.6 MPa
Operating pressure	-0.9 ... 10 bar	-0.9 ... 16 bar	-0.9 ... 16 bar	-0.9 ... 16 bar
Standard nominal flow rate	125 ... 2900 l/min	400 ... 1100 l/min	1200 ... 6000 l/min	4100 ... 6000 l/min
Valve function	2x2/2 closed, monostable, 2x3/2, closed, monostable, 2x3/2, open, monostable, 2x3/2, open/closed, monostable, 3/2, closed, monostable, 5/2, bistable, 5/2, bistable, dominant, 5/2, monostable, 5/3 pressurized 1 to 2, 4 to 5 closed, 5/3, pressurized, 5/3, exhausted, 5/3, closed, 5/3, connection 2 pressurized, 4 exhausted, 5/3, connection 4 pressurized, 2 exhausted	2x3/2, closed, monostable, 2x3/2, open, monostable, 2x3/2, open/closed, monostable, 5/2, bistable, 5/2, bistable, dominant, 5/2, monostable, 5/3, pressurized, 5/3, exhausted, 5/3, closed	5/2, bistable, 5/2, bistable, dominant, 5/2, monostable, 5/3, pressurized, 5/3, exhausted, 5/3, closed	2x3/2, closed, monostable, 2x3/2, open, monostable, 2x3/2, open/closed, monostable, 5/2, bistable, 5/2, bistable, dominant, 5/2, monostable, 5/3, pressurized, 5/3, exhausted, 5/3, closed
Electrical connection	2-pin, 4-pin, Plug-in, Plug, as per ISO 15407-2, as per ISO 5599-2		Central plug, as per DIN EN 175301-803, Round design, Via F coil, to be ordered separately, Via N1 coil, to be ordered separately, M12x1	
Description	<ul style="list-style-type: none"> • For valve manifold VTSA/VTSA-F • Robust metal housing 	<ul style="list-style-type: none"> • Conforms to ISO 15407-1 • Pneumatic actuation • Manifold assembly with mixed sizes possible 	<ul style="list-style-type: none"> • Corresponds to ISO 5599-1 • Robust metal housing • Manifold assembly with a mixture of ISO sizes 1, 2, and 3 possible • Extensive range of electrical connection options • Wide range of vertical stacking modules: pressure regulating valve, throttle plate, vertical pressure shut-off plate, etc. • Also available as a valve manifold 	<ul style="list-style-type: none"> • Corresponds to ISO 5599-1 • Pneumatic actuation
online: →	vsva	vspa	iso 5599-1	iso 5599-1

Electrically and pneumatically actuated directional control valves >





Standards-based directional control valves

	 Pilot valves, ISO 15218 (CNOMO) MDH, MGXDH, MGXIAH	 Standards-based valves, to ISO 15218 (CNOMO) VSCS	 Standard valve with valve pilot control VSVA
Actuation type	Electrical	Electrical	Electrical
Pneumatic connection 1	Sub-base	Sub-base	Sub-base, size 1 as per ISO 5599-1, Sub-base, size 2 as per ISO 5599-1
Operating pressure [MPa]	-0.09 ... 1.6 MPa	0 ... 1 MPa	-0.09 ... 1.6 MPa
Operating pressure	-0.9 ... 16 bar	0 ... 10 bar	-0.9 ... 16 bar
Standard nominal flow rate	50 l/min	13.5 ... 34 l/min	
Valve function	3/2, closed, monostable	3/2, closed, monostable	2/2, closed, monostable, 2x2/2 closed, monostable, 2x3/2, closed, monostable, 2x3/2, open, monostable, 2x3/2, open/ closed, monostable, 5/2, bistable, 5/2, bistable, dominant, 5/2, monostable, 5/3 pressurized 1 to 2, 4 to 5 closed, 5/3, pressurized, 5/3, exhausted, 5/3, closed, 5/3, connection 2 pressurized, 4 exhausted, 5/3, connection 4 pressurized, 2 exhausted
Electrical connection	Form A, as per DIN EN 175301-803	Form C, Connection diagram form C as per industrial standard, 9.4 mm, as per DIN EN 175301-803, as per IEC 61076-2-101, M12x1	Form A, Form B, Form C, M12x1, A-coded according to DESINA, M12x1, A-coded as per EN 61076-2-101, as per EN 175301-803
Description	<ul style="list-style-type: none"> • CNOMO port and connection pattern, to ISO 15218 • Detenting or non-detenting manual override • Variants in accordance with EU Explosion Protection Directive (ATEX) 	<ul style="list-style-type: none"> • Valve attachment for electrical control of valve bodies • CNOMO port and connection pattern, to ISO 15218 • Detenting or non-detenting manual override 	<ul style="list-style-type: none"> • Corresponds to ISO 5599-1 • Robust metal housing • Comprehensive valve functions: 5/2, 5/3, 2x3/2, 2x2/2 • Extensive range of electrical connection options • Wide range of voltage variants, direct and alternating voltages • Wide range of vertical stacking modules: pressure regulating valve, throttle plate, vertical pressure shut-off plate, etc. • Convenient valve configurator for selecting the desired valve type • Manifold assembly with a mixture of ISO sizes 1, 2, and 3 possible
online: →	iso 15218	VSCS	vsva

Product overview



Electrically and pneumatically actuated directional control valves >

Universal directional control valves

	 Solenoid valves, for individual connection VUVG	 Solenoid valves, plug-in VUVX-T1	 Solenoid valves, plug-in VUVG-T1	 Solenoid valves, plug-in VUVG-B-F1A
Actuation type	Electrical	Electrical	Electrical	Electrical
Pneumatic connection 1	G1/4, G1/8, M3, M5, M7	Sub-base		
Pneumatic working port	Flange, G1/4, G1/8, M3, M5, M7, QS-1/4, QS-1/8, QS-10, QS-3, QS-3/16, QS-3/8, QS-4, QS-5/16, QS-5/32, QS-6, QS-8		Flange, G1/4, G1/8, M5, M7	Flange
Operating pressure [MPa]	-0.09 ... 1 MPa	-0.09 ... 0.7 MPa	-0.09 ... 1 MPa	-0.09 ... 1 MPa
Operating pressure	-0.9 ... 10 bar	-0.9 ... 7 bar	-0.9 ... 10 bar	-0.9 ... 10 bar
Standard nominal flow rate	80 ... 1380 l/min		130 ... 1200 l/min	130 ... 510 l/min
Valve function	2x3/2, closed, monostable, 2x3/2, open, monostable, 2x3/2, open/closed, monostable, 5/2, bistable, 5/2, monostable, 5/3, pressurized, 5/3, exhausted, 5/3, closed	2x3/2, closed, monostable, 2x3/2, open, monostable, 5/2, bistable, 5/2, monostable, 5/3, closed, 5/4 exhausted	2x3/2, closed, monostable, 2x3/2, open, monostable, 2x3/2, open/closed, monostable, 3/2, closed, monostable, 3/2, open, monostable, 5/2, bistable, 5/2, monostable, 5/3, pressurized, 5/3, exhausted, 5/3, closed	2x3/2, closed, monostable, 2x3/2, open, monostable, 2x3/2, open/closed, monostable, 5/2, bistable, 5/2, monostable, 5/3, pressurized, 5/3, exhausted, 5/3, closed
Electrical connection	2-pin, 3-pin, Connection diagram H, horizontal connection, M8x1 A-coded as per EN 61076-2-104, Plug, Via electrical sub-base, Via electric pilot valve	Plug-in	Via sub-base	Via sub-base
Description	<ul style="list-style-type: none"> • Compact universal valve • Connection technology via electrical connection box (E-box) • High flow rate relative to its size • In-line valves can be used as individual valves or manifold valves 	<ul style="list-style-type: none"> • Sub-base valve, semi in-line valve • Valve manifold VTUG with multi-pin plug, fieldbus interface • Variants in accordance with EU Explosion Protection Directive (ATEX) 	<ul style="list-style-type: none"> • Sub-base valve, semi in-line valve • Valve manifold VTUG with multi-pin plug, fieldbus interface • Variants in accordance with EU Explosion Protection Directive (ATEX) 	<ul style="list-style-type: none"> • Sub-base valve • Valve manifold VTUG with multi-pin plug, fieldbus interface • Recommended for production systems for the manufacture of Li-ion batteries (F1A)
online: →	vuvg	vuvx	vuvg	vuvg_t1_f1a

Electrically and pneumatically actuated directional control valves >

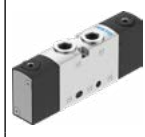

Universal directional control valves

	 Solenoid valves VUVG-L-F1A	 Pneumatic valves VUWG	 Solenoid valves VUVS	 Pneumatic valves VUWS
Actuation type	Electrical	Pneumatic	Electrical	Pneumatic
Pneumatic connection 1	G1/4, G1/8, M5, M7	G1/4, G1/8, M3, M5, M7	G1/4, 1/8 NPT, 1/4 NPT, 3/8 NPT, G1/4, G1/8, G3/8	1/8 NPT, 1/4 NPT, 3/8 NPT, G1/4, G1/8, G3/8
Pneumatic working port	G1/4, G1/8, M5, M7	G1/4, G1/8, M3, M5, M7, QS-1/4, QS-1/8, QS-10, QS-3, QS-3/16, QS-3/8, QS-4, QS-5/16, QS-5/32, QS-6, QS-8	G1/4, 1/8 NPT, 1/4 NPT, 3/8 NPT, G1/4, G1/8, G3/8, QS-1/2, QS-1/4, QS-10, QS-12, QS-3/8, QS-4, QS-5/16, QS-5/32, QS-6, QS-8	1/8 NPT, 1/4 NPT, 3/8 NPT, G1/4, G1/8, G3/8, QS-1/4, QS-10, QS-3/8, QS-4, QS-5/16, QS-5/32, QS-6, QS-8
Operating pressure [MPa]	-0.09 ... 1 MPa		-0.09 ... 1 MPa	-0.09 ... 1 MPa
Operating pressure	-0.9 ... 10 bar	-0.9 ... 10 bar	-0.9 ... 10 bar	-0.9 ... 10 bar
Standard nominal flow rate	125 ... 1380 l/min	80 ... 1380 l/min	500 ... 2400 l/min	500 ... 2400 l/min
Valve function	2x3/2, closed, monostable, 2x3/2, open, monostable, 2x3/2, open/closed, monostable, 5/2, bistable, 5/2, monostable, 5/3, pressurized, 5/3, exhausted, 5/3, closed	2x3/2, closed, monostable, 2x3/2, open, monostable, 2x3/2, open/closed, monostable, 5/2, bistable, 5/2, monostable, 5/3, pressurized, 5/3, exhausted, 5/3, closed	2x3/2, closed, monostable, 2x3/2, open, monostable, 2x3/2, open/closed, monostable, 3/2, closed, monostable, 3/2, open, monostable, 5/2, bistable, 5/2, monostable, 5/3, pressurized, 5/3, exhausted, 5/3, closed	2x3/2, closed, monostable, 2x3/2, open, monostable, 2x3/2, open/closed, monostable, 3/2, closed, monostable, 3/2, open, monostable, 5/2, bistable, 5/2, monostable, 5/3, pressurized, 5/3, exhausted, 5/3, closed
Electrical connection	2-pin, Connection diagram H, horizontal connection, Plug		3-pin, Socket, Form B, Form C, Screw terminal, as per EN 175301-803, As per industrial standard (11 mm)	
Description	<ul style="list-style-type: none"> • Compact universal valve • Connection technology via electrical connection box (E-box) • High flow rate relative to its size • In-line valves can be used as individual valves or manifold valves • Recommended for production systems for the manufacture of Li-ion batteries (F1A) 	<ul style="list-style-type: none"> • Compact universal valve • Pneumatically actuated • High flow rate relative to its size • In-line valves can be used as individual valves or manifold valves • Can be combined on manifold rail with electric individual valves 	<ul style="list-style-type: none"> • Universal valve, sturdy and durable • Low-cost with no performance limitations • Can be used as individual valves or manifold valves VTUS 	<ul style="list-style-type: none"> • Universal valve, sturdy and durable • Pneumatically actuated • Can be used as individual valves or manifold valves VTUS
online: →	vuvg_s_f1a	vuwg	vuvs	vuws

Product overview





Electrically and pneumatically actuated directional control valves >

Universal directional control valves

			
	Solenoid valves VMPA1, VMPA14, VMPA2	Solenoid and pneumatic valves, Tiger Classic MCH, MFH, MOFH, MOCH, JMFH, JMFDH, VL/O, VL, JH, JDH	Solenoid valves, supplementary product range BMCH, BMFH, MC, MCH, MFH, MOCH, MOFH
Actuation type	Electrical	Electrical, Pneumatic	Electrical
Pneumatic connection 1	Internal, G1/8, M7	1/8 NPT, 1/4 NPT, 1/2 NPT, G1/2, G1/4, G1/8, G3/4	G1/4, G1/8, M5
Pneumatic working port	G1/8, M7	1/8 NPT, 1/4 NPT, 1/2 NPT, G1/2, G1/4, G1/8, G3/4	G1/8, M5
Operating pressure [MPa]	-0.09 ... 1 MPa	-0.095 ... 1 MPa	-0.095 ... 0.8 MPa
Operating pressure	-0.9 ... 10 bar	-0.95 ... 10 bar	-0.95 ... 8 bar
Standard nominal flow rate	140 ... 870 l/min	500 ... 7500 l/min	46 ... 300 l/min
Valve function	2x2/2 closed, monostable, 2x3/2, closed, monostable, 2x3/2, open, monostable, 2x3/2, open/closed, monostable, 3/2, closed, monostable, 3/2, open, monostable, 5/2, bistable, 5/2, monostable, 5/3, pressurized, 5/3, exhausted, 5/3, closed	3/2, closed, monostable, 3/2, open, monostable, 3/2, open/closed, monostable, 5/2, bistable, 5/2, bistable, dominant, 5/2, closed, monostable, 5/2, monostable	2/2, closed, monostable, 2x3/2, closed, monostable, 3/2, closed, monostable, 3/2, open, monostable, 3x3/2, closed, monostable
Electrical connection	4-pin, Plug, as per EN 60947-5-2, M8x1	Via F coil, to be ordered separately	Plug
Description	<ul style="list-style-type: none"> • For valve manifold MPA • As individual valve mounted on sub-base • Comprehensive valve range 	<ul style="list-style-type: none"> • Sturdy and reliable • Poppet valve • All-metal version • Principle with armature guide tube • Variants in accordance with EU Explosion Protection Directive (ATEX) 	<ul style="list-style-type: none"> • Manifold mounting or individual valve • Valves for special applications • With or without manual override
online: →	vmpa1	tiger classic	bmch

Electrically and pneumatically actuated directional control valves >





Application-specific directional control valves

	 Control blocks VOFA	 Solenoid valves VOFC	 Solenoid valves VOFD	 Solenoid valves VOVG
Design	Piston gate valve	Piston gate valve, Pilot-controlled piston poppet valve	Directly controlled poppet valve	Piston gate valve
Valve function	3/2, closed, monostable, 5/2, monostable	3/2, closed, monostable, 5/2, bistable, 5/2, monostable	3/2, closed, monostable, semi-automatic, 3/2, closed, monostable	3/2, closed, monostable, 3/2, open, monostable, 5/2, monostable
Operating pressure [MPa]	0 ... 1 MPa	0 ... 1 MPa	0 ... 1.2 MPa	-0.09 ... 0.8 MPa
Operating pressure	0 ... 10 bar	0 ... 10 bar	0 ... 12 bar	-0.9 ... 8 bar
Ambient temperature	-5 ... 50°C	-25 ... 60°C	-50 ... 60°C	-5 ... 50°C
Pneumatic connection 1	G1/4	1/4 NPT, 1/2 NPT, NAMUR connection diagram, G1/2, G1/4, M5	1/4 NPT, NAMUR connection diagram, G1/4, M5	Sub-base, M5, M7
Standard nominal flow rate	950 ... 1050 l/min	595 ... 2794 l/min	52 ... 1900 l/min	180 ... 200 l/min
Description	<ul style="list-style-type: none"> • Redundantly designed valve block for safe reversing of a hazardous movement or for safe venting of pneumatic drives • Can be selected as a decentralized individual connection variant with electrical and pneumatic individual connection or as a feature integrated in the valve manifold VTSA/VTSA-F • Equipped with pneumatic valves VSVA • Switching position sensing by sensors • With safety functions • Suitable for use as a press safety valve in accordance with ISO 16092-4 	<ul style="list-style-type: none"> • Suitable for process automation in the chemical and petrochemical industries • Suitable for outdoor use under harsh, dusty ambient conditions • Especially suitable for quarter turn actuators thanks to NAMUR flange pattern • Pneumatic valve can switch between internal and external pilot air • Variants with safety functions • Variants in accordance with EU Explosion Protection Directive (ATEX) 	<ul style="list-style-type: none"> • Suitable for process automation in the chemical and petrochemical industries • Suitable for outdoor use under harsh, dusty ambient conditions • Especially suitable for quarter turn actuators thanks to NAMUR flange pattern • Variants with safety functions • Variants in accordance with EU Explosion Protection Directive (ATEX) 	<ul style="list-style-type: none"> • Very compact pneumatic valve for solutions with extremely compact assembly • For soft-start/quick exhaust valves MS6-SV, MS series • In-line, semi in-line, and sub-base valve • Manifold rail for 2 ... 10 pneumatic valves
online: →	vofa	vofc	vofd	vofg

Product overview



Electrically and pneumatically actuated directional control valves >

Application-specific directional control valves

	 Solenoid valves MHA1, MHP1	 Solenoid valves MHE2, MHP2, MHA2, MHE3, MHP3, MHA3, MHE4, MHP4, MHA4	 Solenoid valves CDVI5.0	 Fast-switching valves MHJ9, MHJ10
Design	Poppet valve with return spring	Pressure-relieved poppet valve	Piston gate valve	Poppet valve without return spring
Valve function	2/2, closed, monostable, 2x2/2 closed, monostable, 3/2, closed, monostable, 3/2, open, monostable	3/2, closed, monostable, 3/2, open, monostable, 5/2, monostable	2/2, closed, monostable, 2/2, open, monostable, 2x3/2, closed, monostable, 2x3/2, open, monostable, 3/2, closed, monostable, 3/2, open, monostable, 5/2, bistable, 5/2, monostable, 5/3, pressurized, 5/3, exhausted, 5/3, closed	2/2, closed, monostable
Operating pressure [MPa]	-0.09 ... 0.8 MPa	-0.09 ... 0.8 MPa	-0.9 ... 10 bar	0.05 ... 0.8 MPa
Operating pressure	-0.9 ... 8 bar	-0.9 ... 8 bar	-0.9 ... 10 bar	0.5 ... 8 bar
Ambient temperature	-5 ... 50°C	-5 ... 60°C	-5 ... 50°C	-5 ... 60°C
Pneumatic connection 1	Sub-base, Prepared for QSP10, QS-3, QS-4	Sub-base, G1/4, G1/8, M7, QS-4, QS-6, QS-8	Sub-base	Sub-base, QS-4, QS-6
Standard nominal flow rate	10 ... 30 l/min	90 ... 400 l/min	300 ... 650 l/min	50 ... 160 l/min
Description	<ul style="list-style-type: none"> • Directly actuated poppet valve • Miniature valve: width dimension 10 mm • Switching times down to 4 ms • Sub-base valve • Manifold block for 2 ... 10 pneumatic valves • Use as a pilot valve • UL certification; same connections and cables as for VUVG 	<ul style="list-style-type: none"> • Directly actuated poppet valve • Fast-switching valve: switching times down to 2 ms • Direct mounting, individual sub-base, manifold assembly • Manifold block for 2 ... 10 pneumatic valves 	<ul style="list-style-type: none"> • Clean Design sub-base valve • Easy-to-clean design • Individual valve for Clean Design • Can be used in the food zone (based on standard EN 1672-2) 	<ul style="list-style-type: none"> • Directly actuated poppet valve • Identical basic valves for direct mounting or manifold installation • Individual valve with integrated QS fitting • Switching frequencies up to 1000 Hz • Very good reproducibility • MHJ9: Valve manifold assembly with individual outputs or with air nozzle output • MHJ9: Electrical connection via connecting cable MHJ9-KMH with integrated control electronics • MHJ10: Valve manifold assembly with individual outputs • MHJ10: Electrical connection via molded-in cable, control electronics included in the valve
online: →	mh1	mh2	cdvi5.0	mhj9

Electrically and pneumatically actuated directional control valves >

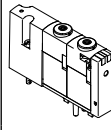
Application-specific directional control valves

	 Solenoid valves VOVK	 Solenoid valves VOVC	 Pilot valves VOFX
Design	Connection direction downwards, Connection direction to the front, Poppet valve with return spring	Poppet valve with return spring	Directly controlled poppet valve
Valve function	3/2, closed, monostable	2x3/2, closed, monostable	3/2, closed, monostable
Operating pressure [MPa]	-0.1 ... 0.7 MPa	0 ... 0.8 MPa	-0.09 ... 0.8 MPa
Operating pressure	-1 ... 7 bar	0 ... 8 bar	-0.9 ... 8 bar
Ambient temperature	5 ... 50°C	-5 ... 50°C	-10 ... 50°C
Pneumatic connection 1	Sub-base, For tubing I.D. 1.5 mm, For tubing I.D. 2 mm	Sub-base	G1/8
Standard nominal flow rate	5.5 l/min		50 l/min
Description	<ul style="list-style-type: none"> • Extra narrow: 5.9 mm width dimension • Extremely small and lightweight • Very low power consumption • Variable connection concepts: flanged connection at bottom or front, front barbed fitting connection • Ideal for control of small air flows 	<ul style="list-style-type: none"> • For valve manifold VTOC • Optimal construction space usage yet maximum performance • Detenting or non-detenting manual override 	<ul style="list-style-type: none"> • For angle seat valves VZXF and VZXA • For use wherever valve manifolds are not economically or technically viable • Manual override, detenting
online: →	vovk	vovc	vofx

Electrically and pneumatically actuated directional control valves >

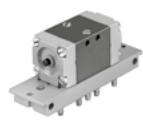
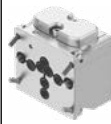
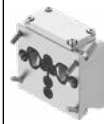

Application-specific directional control valves

	 Solenoid and pneumatic valves, M5 Compact System J, JD, JMFH, MFH, VD, VL, VL/O, VLL	 Pneumatic valves VOGM	 Pneumatic valves VOGI
Design	Piston gate valve, Plate seat	Sub base valve, Diaphragm valve, Pilot-controlled piston poppet valve	Sub base valve, Pilot-controlled piston poppet valve
Valve function	3/2, bistable, 3/2, open, monostable, 5/2, bistable, 5/2, bistable, dominant, 5/2, monostable	Proportional 3/3-way valve	4/2, monostable, Fail safe
Operating pressure [MPa]	0 ... 0.8 MPa	0.14 ... 0.8 MPa	0.33 ... 0.8 MPa
Operating pressure	-0.9 ... 8 bar	1.4 ... 8 bar	3.3 ... 8 bar
Ambient temperature	-10 ... 60°C	-40 ... 80°C	-20 ... 80°C
Pneumatic connection 1	PK-3		G1/2
Standard nominal flow rate	100 ... 105 l/min	1240 l/min	1093 l/min
Description	<ul style="list-style-type: none"> • Control elements with all functions for pneumatic sequence controls • For control cabinet installation • Fast replacement of components 	<ul style="list-style-type: none"> • Pneumatic extension module for valve terminal VTOP • Volume booster for shortening the actuating times of the Angle seat fitting • Precise positioning of the pneumatic actuator even with fast positioning times through direct integration into the control loop 	<ul style="list-style-type: none"> • Pneumatic extension module for valve terminal VTOP • Fail safe modules for approaching a defined end position in the event of pressure failure
online: →	m5-compact	vogm	vogi

Product overview



Manually actuated directional control valves >

Swivel lever valves

	 Hand lever valves VHEF-H	 Hand lever valves, NPT VHEF-H	 Hand lever valves VHER
Valve function	3/2, bistable, 3/2, open/closed, monostable, 5/2, bistable, 5/2, monostable, 5/3, exhausted, 5/3, closed	3/2, bistable, 3/2, open/closed, monostable, 5/2, bistable, 5/2, monostable, 5/3, exhausted, 5/3, closed	4/3, pressurized, 4/3, exhausted, 4/3, closed
Type of control	Direct	Direct	Direct
Standard nominal flow rate	530 ... 1200 l/min	530 ... 1200 l/min	170 ... 3800 l/min
Pneumatic working port	G1/4, G1/8	1/8 NPT, 1/4 NPT	G1/2, G1/4, G1/8, M5
Operating pressure [MPa]	-0.095 ... 1 MPa	-0.095 ... 1 MPa	
Operating pressure	-0.95 ... 10 bar	-0.95 ... 10 bar	0 ... 10 bar
Description	<ul style="list-style-type: none"> • With side hand lever • Durable thanks to tried-and-tested piston slide and disc seat valve technology • Robust metal housing • Attractive price • Ergonomic and safe operation • Minimal actuating forces • Modern design • Reverse operation possible 	<ul style="list-style-type: none"> • With side hand lever • Durable thanks to tried-and-tested piston slide and disc seat valve technology • Robust metal housing • Attractive price • Ergonomic and safe operation • Minimal actuating forces • Modern design • Reverse operation possible 	<ul style="list-style-type: none"> • Lever in metal or polymer design • Front panel mounting, through or mounting holes
online: →	vhf	vhf	vher



Manually actuated directional control valves >

Swivel lever valves

	 Hand lever valves VHER	 Hand lever valves H-3, H-5
Valve function	4/3, exhausted, 4/3, closed	3/2, bistable, 5/2, bistable
Type of control	Direct	Direct
Standard nominal flow rate	600 ... 3800 l/min	550 ... 600 l/min
Pneumatic working port	NPT1/2-14, NPT1/4-18, NPT1/8-27	G1/4
Operating pressure [MPa]		
Operating pressure	0 ... 10 bar	-0.95 ... 10 bar
Description	<ul style="list-style-type: none"> • With NPT connecting thread • Lever in metal version • Front panel mounting, through or mounting holes 	<ul style="list-style-type: none"> • Die-cast aluminum design
online: →	vher	n_v14



Manually actuated directional control valves >

Pushbutton valves

	 Pushbutton valves VHEF-P	 Pushbutton valves, NPT VHEF-P	 Pushbutton valves K/O-3
Valve function	3/2, bistable, 3/2, open/closed, monostable, 5/2, bistable, 5/2, monostable	3/2, bistable, 3/2, open/closed, monostable, 5/2, bistable, 5/2, monostable	3/2, open/closed, monostable
Type of control	Direct, Pilot-controlled	Direct, Pilot-controlled	Direct
Standard nominal flow rate	750 ... 1200 l/min	750 ... 1200 l/min	80 l/min
Pneumatic working port	G1/4, G1/8	1/8 NPT, 1/4 NPT	PK-3
Operating pressure [MPa]	-0.095 ... 1 MPa	-0.095 ... 1 MPa	
Operating pressure	-0.95 ... 10 bar	-0.95 ... 10 bar	0 ... 8 bar
Description	<ul style="list-style-type: none"> • With button switch • Durable thanks to tried-and-tested piston slide and disc seat valve technology • Robust metal housing • Attractive price • Ergonomic and safe operation • Minimal actuating forces • Modern design • Reverse operation possible 	<ul style="list-style-type: none"> • With button switch • Durable thanks to tried-and-tested piston slide and disc seat valve technology • Robust metal housing • Attractive price • Ergonomic and safe operation • Minimal actuating forces • Modern design • Reverse operation possible 	<ul style="list-style-type: none"> • With button switch • Polymer design • Ducted exhaust air
online: →	vhf	vhf	k

Manually actuated directional control valves >



Pushbutton valves

	 Pushbutton valves K-3	 Pushbutton valves T-5/3	 Pushbutton valves F-3
Valve function	3/2, closed, monostable	5/3, closed	3/2, closed, monostable
Type of control	Direct	Pilot-controlled	Direct
Standard nominal flow rate	80 l/min	680 l/min	80 l/min
Pneumatic working port	M5	G1/4	M5
Operating pressure [MPa]		0.2 ... 1 MPa	
Operating pressure	-0.95 ... 8 bar	2 ... 10 bar	-0.9 ... 8 bar
Description	<ul style="list-style-type: none"> • With button switch • Suitable for vacuum operation • Sturdy die-cast zinc design 	<ul style="list-style-type: none"> • With pushbutton • For positioning, for stopping in the event of an emergency stop and for holding double-acting cylinders in any position • Aluminum design 	<ul style="list-style-type: none"> • With pedal • Suitable for vacuum operation • Sturdy die-cast zinc design
online: →	k-3	n_msv	f-3-m5

Product overview



Manually actuated directional control valves >

Finger lever valves

	 Finger lever valves VHEF-L	 Finger lever valves, NPT VHEF-L	 Finger lever valves TH/O-3
Valve function	3/2, open/closed, monostable, 5/2, monostable	3/2, open/closed, monostable, 5/2, monostable	3/2, open/closed, monostable
Type of control	Direct	Direct	Direct
Standard nominal flow rate	750 ... 1200 l/min	750 ... 1200 l/min	80 l/min
Pneumatic working port	G1/4, G1/8	1/8 NPT, 1/4 NPT	PK-3
Operating pressure [MPa]	-0.095 ... 1 MPa	-0.095 ... 1 MPa	
Operating pressure	-0.95 ... 10 bar	-0.95 ... 10 bar	0 ... 8 bar
Description	<ul style="list-style-type: none"> • With finger lever • Durable thanks to tried-and-tested piston slide and disc seat valve technology • Robust metal housing • Attractive price • Ergonomic and safe operation • Minimal actuating forces • Modern design • Reverse operation possible 	<ul style="list-style-type: none"> • With finger lever • Durable thanks to tried-and-tested piston slide and disc seat valve technology • Robust metal housing • Attractive price • Ergonomic and safe operation • Minimal actuating forces • Modern design • Reverse operation possible 	<ul style="list-style-type: none"> • With finger lever • Polymer design • Ducted exhaust air
online: →	vhf	vhf	th





Manually actuated directional control valves >

Finger lever valves

	 Finger lever valves TH-3, THO-3, TH-5	 Finger lever valves H-4/3
Valve function	3/2, closed, monostable, 3/2, open, monostable, 5/2, monostable	4/3, exhausted
Type of control	Direct	Pilot-controlled
Standard nominal flow rate	80 ... 600 l/min	125 l/min
Pneumatic working port	G1/4, M5	M5
Operating pressure [MPa]		
Operating pressure	-0.95 ... 10 bar	0 ... 8 bar
Description	<ul style="list-style-type: none"> • With finger lever • Die-cast zinc or die-cast aluminum design 	<ul style="list-style-type: none"> • With detenting finger lever • Front panel mounting or mounting on sub-base • Aluminum design
online: →	th-3-m5	h-4



Manually actuated directional control valves >

Toggle lever valves

	 Toggle lever valves VHEF-V	 Toggle lever valves, NPT VHEF-V	 Toggle lever valves KH/O-3	 Toggle lever valves H-5/3
Valve function	3/2, bistable, 3/2, open/closed, monostable, 5/2, bistable, 5/2, monostable	3/2, bistable, 3/2, open/closed, monostable, 5/2, bistable, 5/2, monostable	3/2, open/closed, monostable	5/3, closed
Type of control	Direct	Direct	Direct	Pilot-controlled
Standard nominal flow rate	750 ... 1200 l/min	750 ... 1200 l/min	80 l/min	680 l/min
Pneumatic working port	G1/4, G1/8	1/8 NPT, 1/4 NPT	PK-3	G1/4
Operating pressure [MPa]	-0.095 ... 1 MPa	-0.095 ... 1 MPa		0.2 ... 1 MPa
Operating pressure	-0.95 ... 10 bar	-0.95 ... 10 bar	0 ... 8 bar	2 ... 10 bar
Description	<ul style="list-style-type: none"> • With toggle lever • Durable thanks to tried-and-tested piston slide and disc seat valve technology • Robust metal housing • Attractive price • Ergonomic and safe operation • Minimal actuating forces • Modern design • Reverse operation possible 	<ul style="list-style-type: none"> • With toggle lever • Durable thanks to tried-and-tested piston slide and disc seat valve technology • Robust metal housing • Attractive price • Ergonomic and safe operation • Minimal actuating forces • Modern design • Reverse operation possible 	<ul style="list-style-type: none"> • With toggle lever • Polymer design • Ducted exhaust air 	<ul style="list-style-type: none"> • With toggle lever • For positioning, for stopping in the event of an emergency stop and for holding double-acting cylinders in any position • Aluminum design
online: →	vhf	vhf	kh	n_msv

Manually actuated directional control valves >



Foot valves

	 Foot valves F-3, FO-3, F-5	 Foot valves with detent FP-3, FPB-3, FP-5, FPB-5
Valve function	3/2, closed, monostable, 3/2, open, monostable, 5/2, monostable	3/2, bistable, 5/2, bistable
Type of control	Direct	Direct
Standard nominal flow rate	550 ... 600 l/min	550 ... 600 l/min
Pneumatic working port	G1/4	G1/4
Operating pressure	-0.95 ... 10 bar	-0.95 ... 10 bar
Description	<ul style="list-style-type: none"> • With foot pedal • Sturdy die-cast zinc design 	<ul style="list-style-type: none"> • With foot pedal with detent • Sturdy die-cast zinc design
online: →	fo-3	fpb-3

Product overview



Manually actuated directional control valves >

Selector switch

	 Selector valves VHEF-E	 Selector valves, NPT VHEF-E	 Selector switches HW-6-38
Valve function	3/2, bistable, 3/2, open/closed, monostable, 5/2, bistable, 5/2, monostable, 5/3, exhausted, 5/3, closed	3/2, bistable, 3/2, open/closed, monostable, 5/2, bistable, 5/2, monostable, 5/3, exhausted, 5/3, closed	8/6, bistable
Type of control	Direct	Direct	Direct
Standard nominal flow rate	530 ... 1200 l/min	530 ... 1200 l/min	180 l/min
Pneumatic working port	G1/4, G1/8	1/8 NPT, 1/4 NPT	M5
Operating pressure [MPa]	-0.095 ... 1 MPa	-0.095 ... 1 MPa	
Operating pressure	-0.95 ... 10 bar	-0.95 ... 10 bar	0 ... 8 bar
Description	<ul style="list-style-type: none"> • With selector switch on side or on top • Durable thanks to tried-and-tested piston slide and disc seat valve technology • Robust metal housing • Attractive price • Ergonomic and safe operation • Minimal actuating forces • Modern design • Reverse operation possible 	<ul style="list-style-type: none"> • With selector switch on side or on top • Durable thanks to tried-and-tested piston slide and disc seat valve technology • Robust metal housing • Attractive price • Ergonomic and safe operation • Minimal actuating forces • Modern design • Reverse operation possible 	<ul style="list-style-type: none"> • With rotary knob and arrow • Front panel mounting or mounting on sub-base • With six switching positions
online: →	vhf	vhf	hw-6





Manually actuated directional control valves >

Front panel valves

	 Front panel valves SV/O-3	 Front panel valves SVS-3, SVS-4, SVOS-3	 Front panel valves SV-3, SV-5
Valve function	2x3/2, closed, monostable	3/2, closed, monostable, 3/2, open, monostable, 4/2, monostable	3/2, closed, monostable, 5/2, monostable
Type of control	Direct	Direct, Pilot-controlled	Direct
Standard nominal flow rate	70 l/min	120 l/min	65 ... 95 l/min
Pneumatic working port	PK-3	G1/8	M5
Operating pressure [MPa]		0.35 ... 0.8 MPa	-0.095 ... 0.8 MPa
Operating pressure	0 ... 8 bar	3.5 ... 8 bar	-0.95 ... 8 bar
Description	<ul style="list-style-type: none"> • For actuator attachments such as toggle and selector switches • Reliable coupling system for quick mounting and dismounting • Polymer design 	<ul style="list-style-type: none"> • For actuator attachments such as pushbutton actuators, mushroom pushbuttons, selector switches, toggle switches, key actuators • Reliable coupling system for quick mounting and dismounting 	<ul style="list-style-type: none"> • For actuator attachments such as pushbutton actuators, mushroom pushbuttons, mushroom pushbuttons with detent, selector switches, or toggle levers • Reliable coupling system for quick mounting and dismounting • Polymer design
online: →	sv	svos	sv-3





Mechanically actuated directional control valves >

Stem actuated valves

	 Stem actuated valves VMEF-S	 Stem actuated valves, NPT VMEF-S	 Stem actuated valves V/O-3	 Stem actuated micro valves S-3, SO-3
Valve function	3/2, closed, monostable, 5/2, monostable	3/2, closed, monostable, 5/2, monostable	3/2, closed, monostable, 3/2, open/closed, monostable	3/2, closed, monostable, 3/2, open, monostable
Type of control	Direct, Pilot-controlled	Direct, Pilot-controlled	Direct	Direct
Standard nominal flow rate	750 ... 1200 l/min	750 ... 1200 l/min	80 ... 140 l/min	60 l/min
Pneumatic working port	G1/4, G1/8	1/8 NPT, 1/4 NPT	G1/8, M5, PK-3	PK-3
Operating pressure [MPa]	-0.095 ... 1 MPa	-0.095 ... 1 MPa		
Operating pressure	-0.95 ... 10 bar	-0.95 ... 10 bar	-0.95 ... 8 bar	-0.95 ... 8 bar
Description	<ul style="list-style-type: none"> • Durable thanks to tried-and-tested piston slide and disc seat valve technology • Robust metal housing • Outstanding pneumatic performance • Attractive price • Ergonomic and safe operation • Minimal actuating forces • Modern design • Reverse operation possible 	<ul style="list-style-type: none"> • Durable thanks to tried-and-tested piston slide and disc seat valve technology • Robust metal housing • Outstanding pneumatic performance • Attractive price • Ergonomic and safe operation • Minimal actuating forces • Modern design • Reverse operation possible 	<ul style="list-style-type: none"> • Through-holes in housing • Polymer, aluminum or die-cast zinc design 	<ul style="list-style-type: none"> • Dimensions to DIN 41635, type A • Polymer design • Various actuator attachments
online: →	vmef	vmef	v/o	so

Mechanically actuated directional control valves >



Stem actuated valves

	 Stem actuated valves VS-3, VS-4, VOS-3	 Stem actuated valves V-3, V-5, VO-3	 End stop limit switches with push-in connector SDK, SVK	 End stop signal transducers with push-in connector SDV
Valve function	3/2, closed, monostable, 3/2, open, monostable, 4/2, monostable	3/2, closed, monostable, 3/2, open, monostable, 5/2, monostable	3/2, closed, monostable	
Type of control	Pilot-controlled	Direct	Direct	
Standard nominal flow rate	140 ... 161 l/min	550 ... 600 l/min	16 ... 50 l/min	8 ... 16 l/min
Pneumatic working port	G1/8	G1/4	PK-3	PK-3
Operating pressure [MPa]	0.35 ... 0.8 MPa			
Operating pressure	3.5 ... 8 bar	-0.95 ... 10 bar	-0.9 ... 8 bar	0 ... 8 bar
Description	<ul style="list-style-type: none"> • Aluminum design • Minimal actuating force with pilot control 	<ul style="list-style-type: none"> • Die-cast aluminum design 	<ul style="list-style-type: none"> • For end-position sensing and position control • High accuracy • Stainless steel design 	<ul style="list-style-type: none"> • For end-position sensing and position control • High precision and low actuating forces • Sturdy design
online: →	vos	vo-3	sdk	sdv

Product overview



Mechanically actuated directional control valves >

Roller lever valves

	 Roller lever valves VMEF-R	 Roller lever valves, NPT VMEF-R	 Roller lever valves R/O-3-PK-3
Valve function	3/2, monostable, 5/2, monostable	3/2, monostable, 5/2, monostable	3/2, open/closed, monostable
Type of control	Direct	Direct	Direct
Standard nominal flow rate	750 ... 1200 l/min	750 ... 1200 l/min	80 l/min
Pneumatic working port	G1/4, G1/8	1/8 NPT, 1/4 NPT	PK-3
Operating pressure [MPa]	-0.095 ... 1 MPa	-0.095 ... 1 MPa	
Operating pressure	-0.95 ... 10 bar	-0.95 ... 10 bar	0 ... 8 bar
Description	<ul style="list-style-type: none"> • Durable thanks to tried-and-tested piston slide and disc seat valve technology • Robust metal housing • Outstanding pneumatic performance • Attractive price • Ergonomic and safe operation • Minimal actuating forces • Modern design • Reverse operation possible 	<ul style="list-style-type: none"> • Durable thanks to tried-and-tested piston slide and disc seat valve technology • Robust metal housing • Outstanding pneumatic performance • Attractive price • Ergonomic and safe operation • Minimal actuating forces • Modern design • Reverse operation possible 	<ul style="list-style-type: none"> • With roller lever • Polymer design • Ducted exhaust air
online: →	vmef	vmef	r/o





Mechanically actuated directional control valves >

Roller lever valves

	 Roller lever valves RS-3, RS-4, ROS-3	 Roller lever valves R-3
Valve function	3/2, closed, monostable, 3/2, open, monostable, 4/2, monostable	3/2, closed, monostable, 3/2, open, monostable, 5/2, monostable
Type of control	Pilot-controlled	Direct
Standard nominal flow rate	128 ... 169 l/min	80 ... 600 l/min
Pneumatic working port	G1/8	G1/4, M5
Operating pressure [MPa]	0.35 ... 0.8 MPa	-0.095 ... 1 MPa
Operating pressure	3.5 ... 8 bar	-0.95 ... 10 bar
Description	<ul style="list-style-type: none"> • With roller lever • Aluminum design • Minimal actuating force with pilot control 	<ul style="list-style-type: none"> • With roller lever • Die-cast aluminum design
online: →	ros-3	ro-3

Mechanically actuated directional control valves >





Roller lever valves

	 Roller lever valves VMEF-K	 Roller lever valves, NPT VMEF-K	 Toggle lever valves L/O-3	 Roller lever valves with idle return L-3, L-5, L0-3
Valve function	3/2, monostable, 5/2, monostable	3/2, monostable, 5/2, monostable	3/2, open/closed, monostable	3/2, closed, monostable, 3/2, open, monostable, 5/2, monostable
Type of control	Direct	Direct	Direct	Direct
Standard nominal flow rate	750 ... 1200 l/min	750 ... 1200 l/min	80 l/min	80 ... 600 l/min
Pneumatic working port	G1/4, G1/8	1/8 NPT, 1/4 NPT	PK-3	G1/4, M5
Operating pressure [MPa]	-0.095 ... 1 MPa	-0.095 ... 1 MPa		
Operating pressure	-0.95 ... 10 bar	-0.95 ... 10 bar	0 ... 8 bar	-0.95 ... 10 bar
Description	<ul style="list-style-type: none"> • Durable thanks to tried-and-tested piston slide and disc seat valve technology • Robust metal housing • Outstanding pneumatic performance • Attractive price • Ergonomic and safe operation • Minimal actuating forces • Modern design • Reverse operation possible 	<ul style="list-style-type: none"> • Durable thanks to tried-and-tested piston slide and disc seat valve technology • Robust metal housing • Outstanding pneumatic performance • Attractive price • Ergonomic and safe operation • Minimal actuating forces • Modern design • Reverse operation possible 	<ul style="list-style-type: none"> • With roller lever with idle return • Polymer design • Ducted exhaust air 	<ul style="list-style-type: none"> • With roller lever • Die-cast aluminum design
online: →	vmef	vmef	l/o	lo-3

Product overview

Mechanically actuated directional control valves >

Swivel lever valves

	 Swivel lever valves, NPT VMEF-V	 Swivel lever valves RW/O-3	 Pneumatic limit valves RWN/O-3	 Swivel lever valves RW-3
Valve function	3/2, monostable, 5/2, monostable	3/2, open/closed, monostable	3/2, open/closed, monostable	3/2, closed, monostable
Type of control	Direct	Direct		Direct
Standard nominal flow rate	750 ... 1200 l/min	80 ... 140 l/min	120 l/min	80 l/min
Pneumatic working port	1/8 NPT, 1/4 NPT	G1/8, PK-3	G1/8	M5
Operating pressure	-0.95 ... 10 bar	-0.95 ... 8 bar	-0.95 ... 8 bar	-0.95 ... 8 bar
Description	<ul style="list-style-type: none"> • Variants with switching range on both sides, left or right • Compact design • Durable thanks to tried-and-tested piston slide and disc seat valve technology • Robust metal housing • Attractive price • Ergonomic and safe operation • Minimal actuating forces • Modern design • Reverse operation possible 	<ul style="list-style-type: none"> • Basic valve for actuator attachments such as swivel lever short, long, swivel lever rod • Aluminum design 	<ul style="list-style-type: none"> • Directly actuated in one direction • Aluminum design 	<ul style="list-style-type: none"> • With swivel lever • Sturdy die-cast zinc design • Various actuator attachments
online: →	vmef	rw	rwn	rw-3





Mechanically actuated directional control valves >

Whisker valves

	 Whisker valves FVS-3, FVSO-3
Valve function	3/2, closed, monostable, 3/2, open, monostable
Type of control	Pilot-controlled
Standard nominal flow rate	146 ... 175 l/min
Pneumatic working port	G1/8
Operating pressure [MPa]	0.35 ... 0.8 MPa
Operating pressure	3.5 ... 8 bar
Description	<ul style="list-style-type: none"> • With whisker • For sensing dissimilar workpieces or workpieces not precisely in position • Aluminum design • Minimal actuating force with pilot control
online: →	fvs-3

Pneumatic shut-off valves >



Check valves

	 Check valves, piloted HGL	 Manual override tools HAB	 Check valves, piloted VBNF	 Check valves H, HA, HB
Pneumatic connection 1	1/8 NPT, 1/4 NPT, 3/8 NPT, 1/2 NPT, G1/2, G1/4, G1/8, G3/8, M5, QS-10, QS-12, QS-4, QS-6, QS-8	G1/2, G1/4, G1/8, G3/8	QS-4, QS-6, QS-8	10-32 UNF-2A, 1/8 NPT, 1/4 NPT, 3/8 NPT, 1/2 NPT, G1/2, G1/4, G1/8, G3/4, G3/8, M5, QS-1/2, QS-1/4, QS-10, QS-12, QS-3/16, QS-3/8, QS-4, QS-5/16, QS-5/32, QS-6, QS-8, R1/2, R1/4, R1/8, R3/8
Standard nominal flow rate	0 ... 1600 l/min		120 ... 260 l/min	115 ... 2230 l/min
Standard nominal flow rate, exhaust 0.6->0.5 MPa (6->5 bar, 87->72.5 psi)		165 l/min		
Standard nominal flow rate 1->2 (0.6->0.5 MPa, 6->5 bar, 87->72.5 psi)	130 ... 1600 l/min		130 ... 620 l/min	1000 ... 5900 l/min
Operating pressure [MPa]	0.02 ... 1 MPa		0.02 ... 1 MPa	0.04 ... 1.2 MPa
Operating pressure	0.2 ... 10 bar	0 ... 10 bar	0.2 ... 10 bar	-1 ... 12 bar
Operating pressure for entire temperature range			0.2 ... 10 bar	
Description	<ul style="list-style-type: none"> • Valve function: piloted non-return function • Screw-in with external thread • Pneumatically piloted • Pilot air connection: M5, G1/8, G1/4, G3/8, QS-4 • Manually actuated exhaust possible with separate accessory 	<ul style="list-style-type: none"> • Valve function: exhaust component • For non-return valve HGL • For manually exhausting air trapped in a cylinder 	<ul style="list-style-type: none"> • Valve function: piloted non-return function • Minimal height • High flow rate • Can be rotated horizontally through 360° when mounted • Manually actuated exhaust possible 	<ul style="list-style-type: none"> • Valve function: non-return function • Screw-in or in-line installation • With connecting thread at both ends, push-in connector at both ends, thread/push-in connector
online: →	hgl	hab	vbnf	h-qs

Product overview





Pneumatic shut-off valves >

Quick exhaust valves

	 Quick exhaust valves VBQF	 Quick exhaust valves SE, SEU
Pneumatic connection 1	G1/4, G1/8, QS-6, QS-8	1/8 NPT, 1/4 NPT, 3/8 NPT, 1/2 NPT, G1/2, G1/4, G1/8, G3/4, G3/8
Standard nominal flow rate, exhaust 0.6->0.5 MPa (6->5 bar, 87->72.5 psi)	850 ... 2500 l/min	390 ... 7500 l/min
Standard nominal flow rate pressurization 0.6->0.5 MPa (6->5 bar, 87->72.5 psi)	350 ... 960 l/min	300 ... 4560 l/min
Operating pressure	0.2 ... 10 bar	0.2 ... 10 bar
Description	<ul style="list-style-type: none"> • Minimal height • High flow rate • Reduced noise emission • Available with muffler • Available with ducted or unducted exhaust air • For higher cycle times 	<ul style="list-style-type: none"> • Valve function: quick exhaust • Stop valve, piloted • Screw-in • With or without muffler
online: →	vbqf	se



Pneumatic shut-off valves >

Shut-off valves and ball valves

	 Hand slide valves VBOH	 On-off valves HE	 Ball valves QH-QS, QHS-QS	 Ball valves QH
Valve function	3/2, bistable	2/2 bistable, 3/2, bistable	2/2 bistable	2/2 bistable
Pneumatic connection 1	G1/2, G1/4, G1/8, G3/4, G3/8, M5	1/8 NPT, 1/4 NPT, 3/8 NPT, 1/2 NPT, QS-1/2, QS-1/4, QS-10, QS-12, QS-3/16, QS-3/8, QS-5/16, QS-6, QS-8, R1/2, R1/4, R1/8, R3/8	QS-4, QS-6, R1/8	G1, G1 1/2, G1/2, G1/4, G3/4, G3/8
Standard nominal flow rate	236 ... 7691 l/min	155.7 ... 834.3 l/min	148 ... 560 l/min	3400 ... 84000 l/min
Operating pressure [MPa]	-0.095 ... 1.2 MPa	-0.095 ... 1 MPa	-0.1 ... 1 MPa	
Operating pressure	-0.95 ... 12 bar	-0.95 ... 10 bar	-1 ... 10 bar	
Description	<ul style="list-style-type: none"> Used as a shut-off function for pressurizing and exhausting compressed air systems, e.g. upstream of air preparation combination units, for air blow guns, and also for exhausting pneumatic cylinders Non-overlapping, so no pressure losses when switching Low installation costs 	<ul style="list-style-type: none"> Stop valve, manually operated Connection: thread at both ends, push-in connector at both ends, thread/push-in connector Different mounting options 	<ul style="list-style-type: none"> Stop valve, manually operated In-line installation, can be screwed in, bulkhead fitting Variants: thread at both ends, push-in connector at both ends, thread/push-in connector 	<ul style="list-style-type: none"> Stop valve, manually operated In-line installation Internal thread at both ends With hand lever Pipe thread to ISO 2281
online: →	vboh	he	qh	qh

Pneumatic shut-off valves >



Logic valves

	 OR gates OS	 Amplifier modules VK	 AND gates ZK
Valve function	OR function		AND function
Pneumatic connection 1	1/8 NPT, 1/4 NPT, G1/2, G1/4, G1/8, PK-3	M5	G1/8, PK-3
Standard nominal flow rate	100 ... 5000 l/min	80 l/min	100 ... 550 l/min
Operating pressure	1 ... 10 bar	0.001 ... 6 bar	1 ... 10 bar
Description	<ul style="list-style-type: none"> Pneumatic control system Mounting via through-holes 	<ul style="list-style-type: none"> For pneumatic sensors 	<ul style="list-style-type: none"> Dual-pressure valve Connects two input signals in the AND function Mounting via through-holes
online: →	os	vk	zk

Product overview





Pressure regulators

Pressure valves

	 Differential pressure regulators LRL, LRLI	 Pressure regulators VRPA	 Pressure regulators VRPA
Design	Directly controlled piston regulator, with continuous compressed air supply		
Pressure regulation range	2 ... 6 bar	1 ... 8 bar	1 ... 8 bar
Standard nominal flow rate		80 ... 130 l/min	95 ... 130 l/min
Nominal flow rate, closed	30 ... 730 l/min		
Nominal flow rate, open	30 ... 760 l/min		
Pneumatic connection 1	R1/8, R1/4, R3/8, R1/2, M5	M5, QS-4, QS-6, QS-8, R1/4, R1/8	1/8 NPT, 1/4 NPT, QS-1/4
Pneumatic connection 2	QS-10, QS-12, QS-4, QS-6, QS-8	QS-4, QS-6, QS-8	QS-1/4, QS-5/16
Ambient temperature	0 ... 60°C	0 ... 60°C	0 ... 60°C
Description	<ul style="list-style-type: none"> • Piston regulating valve with through pressure supply • Constant pressure differential between the input and output • Connections: thread/push-in connector on top or at the side • Without secondary exhaust • Without pressure gauge 	<ul style="list-style-type: none"> • Regulates operating pressure independently of fluctuating inlet pressure • With secondary exhausting and with return flow function • Piston regulating valve with through pressure supply • Greater energy efficiency thanks to movement-specific pressure adjustment • Directly actuated • With optional pressure gauge • Connections: push-in connector at both ends, thread/push-in connector • Sustainable in operation due to reduction of the pressure level 	<ul style="list-style-type: none"> • With NPT connecting thread • Regulates operating pressure independently of fluctuating inlet pressure • With secondary exhausting and with return flow function • Piston regulating valve with through pressure supply • Greater energy efficiency thanks to movement-specific pressure adjustment • Directly actuated • With optional pressure gauge • Connections: push-in connector at both ends, thread/push-in connector • Sustainable in operation due to reduction of the pressure level
online: →	lrl	vrpa	vrpa

Flow control valves >



One-way flow control valves

	 One-way flow control valves VFOE-L	 One-way flow control valves GRLA, GRLZ, GRLSA, CRGRLA	 One-way flow control valve GRLA	 Check valves VFOH
Valve function	Exhaust air flow control non-return function, Supply air flow control non-return function	Exhaust air flow control non-return function, Flow control non-return function, Supply air flow control non-return function	Exhaust air flow control non-return function	Exhaust air flow control non-return function
Pneumatic connection 1	QS-4, QS-6, QS-8, QS-10, QS-10, QS-4, QS-6, QS-8	Female thread G1/4, For barbed connector I.D. 4 Via union nut, 6 Via union nut, G1/2, G1/4, G1/8, G3/4, G3/8, M3, M5, PK-3, PK-3 Via union nut, PK-4, PK-4 Via union nut, PK-6 Via union nut, QS-10, QS-12, QS-3, QS-4, QS-6, QS-8	10-32 UNF-2B, 1/8 NPT, 3/8 NPT, 1/2 NPT, Internal thread 1/4 NPT, QB-1/2, QB-1/4, QB-1/8, QB-3/8, QB-5/16, QB-5/32	QS-10, QS-4, QS-6, QS-8
Standard nominal flow rate in flow control direction	85 ... 750 l/min	0 ... 4320 l/min	216.1 ... 6114.41 l/min	180 ... 530 l/min
Adjusting element	Rotary knob with detent	Internal hexagon, Knurled screw, Slotted screw	Slotted screw	External hexagon
Description	<ul style="list-style-type: none"> • Low-cost solution for standard applications • Simple and reliable adjustment of pneumatic cylinder speed • Extremely easy assembly • Fast commissioning • Compact dimensions 	<ul style="list-style-type: none"> • Functional combination of throttle check valve and piloted non-return valve • Flow control valve, throttling at one end • Polymer, metal, or stainless steel design • Standard, mini, in-line variants with different flow rates • Connections: thread at both ends, push-in connector at both ends, thread/push-in connector 	<ul style="list-style-type: none"> • Flow control valve, throttling at one end • Polymer design • For direct or inline mounting with different flow ranges • Connections: push-in connector at both ends, thread/push-in connector 	<ul style="list-style-type: none"> • Easy-to-clean design • Increased corrosion protection • Can be rotated horizontally through 360° when mounted
online: →	vfoe	grla	grla	vfoh

Product overview



Flow control valves >

One-way flow control valves

	 One-way flow control valves VFOF	 One-way flow control valves GR, GRA	 One-way flow control valves GG, GGO, GRR
Valve function	Exhaust air flow control non-return function	Flow control non-return function	Flow control non-return function
Pneumatic connection 1	QS-4, QS-6, QS-8	Internal thread G1/4, G1/2, G1/4, G1/8, G3/4, G3/8, M3, M5, QB-1/2, QB-1/4, QB-3/8, QB-5/16, QB-5/32, QS-3, QS-4, QS-6, QS-8	G1/2, G1/4
Standard nominal flow rate in flow control direction	120 ... 590 l/min	29.5 ... 3300 l/min	870 ... 1300 l/min
Adjusting element	Internal hexagon	Knurled screw, Slotted screw	Roller lever
Description	<ul style="list-style-type: none"> • Functional combination of throttle check valve and piloted non-return valve • High flow rate • Can be rotated horizontally through 360° when mounted • Compact and can be operated from the side 	<ul style="list-style-type: none"> • Non-return and flow control valve • In-line installation 	<ul style="list-style-type: none"> • Non-return and flow control valve • With roller lever
online: →	vfof	gra	gg



Flow control valves >

One-way flow control valves

	 Precision one-way flow control valves GRP	 One-way flow control valves, M5 Compact System GRF
Valve function	Flow control non-return function	Flow control non-return function
Pneumatic connection 1	G1/8, PK-3, PK-4	PK-3
Standard nominal flow rate in flow control direction	3.8 ... 75.8 l/min	45 l/min
Adjusting element	Rotary knob with scale	Knurled screw
Description	<ul style="list-style-type: none"> • Non-return and flow control valve • Mounting on sub-base or for front panel mounting 	<ul style="list-style-type: none"> • Complete system offering control elements with all the functions required for pneumatic sequence controls • For control cabinet installation • Fast replacement of components
online: →	grp	m5-compact



Flow control valves >

Flow control valves

			
	Flow control silencers VFFK	Flow control valves GRLO	Flow control valves, barbed Y-connector with restrictor GRO, Y-PK3
Valve function	Sound pressure flow control function	Flow control function	Flow control function
Pneumatic connection 1	M5, M7, R1/4, R1/8	M3, M5	G1/4, G1/8, M5, PK-3, QS-3, QS-4, QS-6
Standard flow rate in flow control direction 6 -> 0 bar		33 ... 169 l/min	
Standard nominal flow rate in flow control direction		18 ... 95 l/min	85 ... 350 l/min
Standard flow rate 0.6->0 MPa (6->0 bar, 87->0 psi)	0 ... 420 l/min		
Adjusting element	Knurled screw	Slotted screw	Knurled screw
Description	<ul style="list-style-type: none"> With polymer muffler 	<ul style="list-style-type: none"> Flow control valve, throttling at both ends Standard or mini throttle Precision adjustment for low and medium speeds Connections: thread at both ends, thread/push-in connector Connections: L-outlet Metal version 	<ul style="list-style-type: none"> Flow control valve, throttling at both ends In-line throttle Connections: push-in connector at both ends Connections: in-line, Y-shape Polymer design
online: →	vffk	glo	gro

Flow control valves >



Flow control valves

		
	Precision needle valves GRPO	Exhaust air flow control valves, flow control/silencers GRE, GRU
Valve function	Flow control function	Sound pressure flow control function
Pneumatic connection 1	G1/8, PK-3, PK-4	1/8 NPT, 1/4 NPT, 1/2 NPT, G1/2, G1/4, G1/8, G3/4, G3/8, NPT3/8-18
Standard flow rate in flow control direction 6 -> 0 bar	5.2 ... 129 l/min	
Standard nominal flow rate in flow control direction	3.8 ... 75.8 l/min	520 ... 3600 l/min
Standard flow rate 0.6->0 MPa (6->0 bar, 87->0 psi)		0 ... 8000 l/min
Adjusting element	Rotary knob with scale	Slotted screw
Description	<ul style="list-style-type: none"> Connections: threaded connection at both ends, push-in connector at both ends Metal version 	<ul style="list-style-type: none"> Exhaust air throttle GRE: sintered metal Flow control valve muffler GRU: polymer
online: →	grpo	gre

Product overview



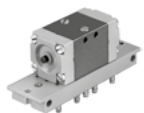

Flow control valves >

Time delay valves

		
	Solenoid and pneumatic valves, M5 Compact System J, JD, JMFH, MFH, VD, VL, VL/O, VLL	Time delay valves, M5 Compact System VLK, VZ, VZO
Pneumatic connection		PK-3
Standard nominal flow rate	100 ... 105 l/min	60 ... 90 l/min
Adjustable delay time		0.25 ... 5 s
Operating pressure	-0.9 ... 8 bar	2.5 ... 8 bar
Type of mounting	Optionally:, On sub-base, On mounting frame, With through-hole	Optionally:, Front panel mounting, On mounting frame
Description	<ul style="list-style-type: none"> Control elements with all functions for pneumatic sequence controls For control cabinet installation Fast replacement of components 	<ul style="list-style-type: none"> Complete system offering control elements with all the functions required for pneumatic sequence controls For control cabinet installation Fast replacement of components
online: →	m5-compact	m5-compact





Proportional valves >

Flow control valves

				
	Proportional directional control valves VPWI	Proportional directional control valves MPYE	Proportional directional control valves VPWP	Proportional directional control valves VPWS
Valve function	3-way proportional directional control valve	5/3, closed	5/3 proportional directional control valve, closed	2/2 proportional directional control valve, closed
Pneumatic connection 1	G1/8	G1/4, G1/8, G3/8, M5	G1/4, G1/8, G3/8	Cartridge 7.5 mm, Cartridge 8 mm, Cartridge 15 mm
Flow rate control range				
Operating pressure [MPa]	0 ... 1.3 MPa	0 ... 1 MPa	0 ... 1 MPa	0 ... 1 MPa
Operating pressure	0 ... 13 bar	0 ... 10 bar	0 ... 10 bar	0 ... 10 bar
Standard nominal flow rate	490 l/min	100 ... 2000 l/min	350 ... 2000 l/min	
Description	<ul style="list-style-type: none"> Dynamic range up to a maximum of 180Hz Full graphic display Stroke limitation Adjustable incline Actual value in pressure or stroke Food grade grease NSFH1 	<ul style="list-style-type: none"> Controlled piston spool valve Analog actuation Setpoint input as analog voltage signal (0 ... 10 V) Suitable for servo-pneumatic applications with SPC11 end-position controller 	<ul style="list-style-type: none"> Controlled piston spool valve Digital actuation Integrated pressure sensors for monitoring function and force control With auto identification Diagnostic function Integrated digital output, e.g. for a clamping/brake unit Suitable for servo-pneumatic applications with stepping motor driver CPX-CMAX and end-position controller CPX-CMPX 	<ul style="list-style-type: none"> Directly actuated poppet valve Operating medium: air, oxygen, inert gases Extremely small and lightweight Compact and cost-effective Mounting: on sub-base
online: →	vpwi	mpye	vpwp	vpws

Proportional valves >





Flow control valves

	 Proportional flow control valves VPCF	 Proportional flow control valves VEMD	 Valve units VPCB	 Mass flow controller VEFC
Valve function	3-way proportional flow control valve	2-way proportional flow control valve	3-way proportional pressure control valve	2-way proportional flow control valve
Pneumatic connection 1	G3/8	Internal thread G1/4, Female thread M5	G3/8	G1/4, R1/4, QS-10, front metal seal 1/4"
Flow rate control range	20 ... 1500 l/min	0 ... 200 l/min		5 ... 200 l/min
Operating pressure [MPa]	0.1 ... 1 MPa	0 ... 0.6 MPa	0.4 ... 0.8 MPa	0.6 MPa
Operating pressure	1 ... 10 bar	0 ... 6 bar	4 ... 8 bar	6 bar
Standard nominal flow rate		50 ... 200 l/min	725 l/min	
Description	<ul style="list-style-type: none"> • Linear characteristic curve for simple programming • As per EU explosion protection directive (ATEX) • Highly dynamic • Piston spool with integrated sensor • Electrical connection via M12x1 plug, 8-pin 	<ul style="list-style-type: none"> • Mass flow controller (MFC) with thermal flow rate sensor and integrated control electronics • Dynamic regulation with short response time • Operating medium: air, oxygen, nitrogen, argon, CO2 • The current flow rate value is available via the interface • Ideal for many applications where inert gases or oxygen need to be controlled • Sustainable operation due to efficient control 	<ul style="list-style-type: none"> • Valve unit for control of a pneumatic cylinder in balancer applications • Comprising 3/3-way proportional pressure control valve with special pressure control and stop valve actuation as well as two shut-off valves designed as 2/2-way stop valves • Diagnostic display for fast error detection 	<ul style="list-style-type: none"> • Very compact: only 24 mm wide • Directly controlled, dynamic piezo valve • Very flexible: customizable control parameters • Outstanding value for money
online: →	vpcf	vemd	vpcb	vefc

Product overview



Proportional valves >

Pressure regulators

	 Proportional pressure regulators MPPES	 Proportional pressure regulators VPPE	 Proportional pressure regulators VPPM	 Proportional-pressure regulators, NPT VPPM
Valve function	3-way proportional pressure control valve closed	3-way proportional pressure control valve, 3-way proportional pressure control valve closed	3-way proportional pressure control valve	3-way proportional pressure control valve
Pneumatic connection 1	G1/2, G1/4, G1/8	G1/8	Sub-base, G1/2, G1/4, G1/8	1/8 NPT, 1/4 NPT, 1/2 NPT
Pressure regulation range [MPa]	0 ... 1 MPa	0.002 ... 1 MPa	0.002 ... 1 MPa	0.002 ... 1 MPa
Pressure regulation range	0 ... 10 bar	0.02 ... 10 bar	0.02 ... 10 bar	0.02 ... 10 bar
Operating pressure [MPa]	≤1.2 MPa	0.8 MPa		
Operating pressure	≤12 bar	8 bar		
Standard nominal flow rate		310 ... 1250 l/min	380 ... 7000 l/min	380 ... 7000 l/min
Description	<ul style="list-style-type: none"> • Directly actuated (G1/8), pilot actuated (G1/4, G1/2) • Setpoint value input as analog voltage or current signal • Choice of pressure regulation ranges • With optional setpoint module • Electrical connection via plug, round design to DIN 45326, M16 x 0.75, 8-pin • With proportional solenoid 	<ul style="list-style-type: none"> • Pilot actuated pressure regulating valve • Setpoint input as analog voltage signal (0 ... 10 V) • Electrical connection via M12x1 plug, 4-pin • With optional setpoint module • Variant with display with three retrievable presets and digital controller electronics • For simple control tasks • Variants recommended for production facilities for the manufacture of lithium-ion batteries 	<ul style="list-style-type: none"> • Fits perfectly into our holistic product portfolio of electromechanical actuators, motors, drive controllers and control systems • Pilot actuated pressure regulating valve • Multi-sensor control (cascade control) • Three default presets for fast commissioning • Integration in valve manifold MPA • User interface with LED displays, LCD display, adjustment/selection buttons • Integrated pressure sensor • Electrical connection via plug, round design, 8-pin, M12 or manifold linking 	<ul style="list-style-type: none"> • Fits perfectly into our holistic product portfolio of electromechanical actuators, motors, drive controllers and control systems • Pilot actuated pressure regulating valve • Multi-sensor control (cascade control) • Three default presets for fast commissioning • Integration in valve manifold MPA • User interface with LED displays, LCD display, adjustment/selection buttons • Integrated pressure sensor • Electrical connection via plug, round design, 8-pin, M12 or manifold linking
online: →	mppes	vppe	vppm	vppm

Proportional valves >



Pressure regulators

	 Proportional pressure regulators VPPX	 Proportional pressure regulator VPPL	 Proportional pressure control valves VEAB
Valve function	3-way proportional pressure control valve	3-way proportional pressure control valve closed	3-way proportional pressure control valve, 3-way proportional pressure control valve closed
Pneumatic connection 1	Sub-base, G1/2, G1/4, G1/8	Flange, G1/4	Flange, QS-4, QS-4
Pressure regulation range [MPa]		0.02 ... 4 MPa	
Pressure regulation range	0.1 ... 10 bar	-0.8 ... 60 bar	
Operating pressure [MPa]		≤5 MPa	
Operating pressure		≤50 bar	
Standard nominal flow rate	1400 ... 7000 l/min	245 l/min	≥4.5 l/min
Description	<ul style="list-style-type: none"> • Pressure regulating valve with additional sensor input • Programmable, freely adjustable PID controller • Multi-sensor control (cascade control) • Control characteristic adjustable via FCT (Festo Configuration Tool) software • Integrated pressure sensor with separate output • Pressure is maintained if the controller fails 	<ul style="list-style-type: none"> • For high-pressure applications • Directly actuated piston regulating valve • Available in three variants: flanged valve, flanged valve with external pilot air supply, in-line valve 	<ul style="list-style-type: none"> • Control vacuum and/or overpressure with a single valve • Highly dynamic pressure control for low flow rates • Highest performance and optionally available with IO-Link® interface • Available as a pipe socket or sub-base valve • Additional IO-Link® features: customizable control parameters, diagnostics, 2-point calibration, etc. • Silent operation and low heat generation • Very short switching times • Sustainable operation due to lower pressure level and efficient control
online: →	vppx	vppl	veab

Product overview





Proportional valves >

Pressure regulators

	 Proportional pressure control valves VEAA	 Proportional pressure regulators VPPI	 Valve manifold VTEP
Valve function	3-way proportional pressure control valve	3-way proportional pressure control valve	3-way proportional pressure control valve closed
Pneumatic connection 1	Flange, QS-4	G1/8	For tubing O.D. 8
Pressure regulation range [MPa]		-0.1 ... 1.2 MPa	-0.1 ... 0.6 MPa
Pressure regulation range		-1 ... 12 bar	-1 ... 6 bar
Operating pressure [MPa]			0.2 ... 0.7 MPa
Operating pressure		0 ... 13 bar	2 ... 7 bar
Standard nominal flow rate	≥7 l/min	150 ... 1630 l/min	
Description	<ul style="list-style-type: none"> • High precision up to 10 bar • Very compact size • Highly dynamic pressure control for very low flow rates • Available as a pipe socket or sub-base valve • Silent operation and low heat generation • Very short switching times • Sustainable operation due to lower pressure level and efficient control 	<ul style="list-style-type: none"> • Fits perfectly into our holistic product portfolio of electromechanical actuators, motors, drive controllers and control systems • Select between three predefined and one customer-specific controller preset • With or without display • Low-noise, flexible and highly dynamic • Precise and stable changeover, rapid switching of setpoint by high-performance plunger coil drive • Control via analog current or voltage signal, digital pattern for adjustable setpoint values or pulse-width modulation signal 	<ul style="list-style-type: none"> • Proportional valve terminal with piezo technology • Very compact: 10 channels on a width of less than 120 mm • Highly dynamic and precise control of pressure and vacuum • Very flexible: customizable control parameters • Digital communication interface EtherCAT • Very low power consumption • No wear and tear, no emissions • Silent operation • Sustainable operation due to efficient control
online: →	veaa	vpqi	vtep

Process valves >



Ball valves

	 Ball valves VZBD	 Ball valves VZBE	 Ball valves VZBF	 Ball valves VAPB
Design	2-way ball valve	2-way ball valve, 2-way ball valve with hand lever, 3-way ball valve, Drilled L hole, Drilled T hole	2-way ball valve	2-way ball valve
Actuation type	Mechanical	Mechanical	Mechanical	Mechanical
Nominal width DN	15, 20, 25, 32, 40, 50, 65, 80, 100	8, 10, 15, 20, 25, 32, 40, 50, 65, 80, 100	15, 20, 25, 32, 40, 50, 65, 80, 100, 150, 200	8, 10, 15, 20, 25, 32, 40, 50, 65
Fitting connection	Clamp as per ASME-BPE, Clamp as per DIN 32676 series A, Weld-on end as per ASME-BPE, Weld-on end as per ISO 1127	1/4 NPT, 3/8 NPT, 1/2 NPT, 3/4 NPT, 1 NPT, 1 1/4 NPT, 1 1/2 NPT, 2 NPT, 2 1/2 NPT, 3 NPT, 4 NPT, Weld-on end according to ASME B16.11	Flange as per ANSI B16.5 class 150	Rp1, Rp1 1/2, Rp1 1/4, Rp1/2, Rp1/4, Rp2, Rp2 1/2, Rp3/4, Rp3/8
Flow rate Kv	13 ... 1641 m ³ /h	5.1 ... 1637 m ³ /h	32 ... 7816 m ³ /h	5.9 ... 535 m ³ /h
Temperature of medium	-20 ... 200°C	-20 ... 200°C	-20 ... 200°C	-20 ... 150°C
Nominal pressure of fitting PN	16	63	20	25, 40
Description	<ul style="list-style-type: none"> • Electropolished surfaces SFV4 • PTFE seal with only little dead space • The high-performance ball valve for the pharmaceutical and cosmetics industry • FDA-compliant seal to FDA 21 CFR 177.1550 	<ul style="list-style-type: none"> • 2-way manual, with lockable hand lever • 2- and 3-way with ISO 5211 head flange, with optional lockable hand lever • Stainless steel design • Pipe thread to ASME B1.20.1 or welded end to ASME B16.11 • Optionally with pre-assembled hand lever 	<ul style="list-style-type: none"> • Flanged connections to ANSI B 16.5. class 150 • Static discharge assured • API 607 Fire Safe certification • Stainless steel design • Easy to service • Optionally with pre-assembled hand lever 	<ul style="list-style-type: none"> • Automatable 2-way ball valve • Brass design • Blow-out proof shaft • Manual operation possible using hand lever • Connecting thread according to EN 10226-1 • Mounting flange to ISO 5211
online: →	vzbd	vzbe	vzbf	vapb

Product overview



Process valves >

Ball valves

	 Ball valves VZBM	 Ball valves VZBA	 Ball valves VZBC
Design	2-way ball valve, 3-way ball valve, Drilled L hole, Drilled T hole	2-way ball valve, 3-way ball valve, Drilled L hole, Drilled T hole	2-way ball valve
Actuation type	Mechanical	Mechanical	Mechanical
Nominal width DN	8, 10, 15, 20, 25, 32, 40, 50	8, 10, 15, 20, 25, 32, 40, 50, 65, 80, 100	15, 20, 25, 32, 40, 50, 65, 80, 100
Fitting connection	Rp1, Rp1 1/2, Rp1 1/4, Rp1/2, Rp1/4, Rp2, Rp3/4, Rp3/8	Weld-on ends/weld-on ends, Rp1, Rp1 1/2, Rp1 1/4, Rp1/2, Rp1/4, Rp2, Rp2 1/2, Rp3, Rp3/4, Rp3/8, Rp4	Ring housing with threaded flange
Flow rate Kv	6 ... 156 m ³ /h	7 ... 1414 m ³ /h	19.4 ... 1414 m ³ /h
Temperature of medium	-20 ... 130°C	-10 ... 200°C	-10 ... 200°C
Nominal pressure of fitting PN	25, 40, 50	63	16, 40
Description	<ul style="list-style-type: none"> • Brass design • Pipe thread to EN 10226-1 	<ul style="list-style-type: none"> • Automatable 2-way or 3-way ball valve • Stainless steel design • Blow-out proof shaft • Manual operation possible using hand lever • Connecting thread according to EN 10226-1 • Mounting flange to ISO 5211 • Use in zone 1, 21, 2, 22 	<ul style="list-style-type: none"> • Automatable 2-way ball valve with compact flange • Stainless steel design • Short installed length • Blow-out proof shaft • Manual operation possible using hand lever • Flange to DIN 1092-1 • Mounting flange to ISO 5211 • Use in zone 1, 21, 2, 22
online: →	vzbm	vzba	vzbc

Process valves >



Angle seat valves

	 Angle seat valves VZXA	 Angle seat valves VZXF
Design	Poppet valve with piston actuator, Poppet valve with diaphragm actuator	Poppet valve with piston actuator
Actuator size	46 mm, 75 mm, 90 mm	
Valve function	2/2	2/2, closed, monostable
Control function	Closed by reduced spring force, NC, Double-acting, Opened by spring force, N/O, Closed by spring force, NC	
Actuation type	Pneumatic	Pneumatic
Flow rate Kv	4.6 ... 77.9 m ³ /h	3.3 ... 43 m ³ /h
Medium pressure [MPa]	0 ... 3 MPa	-0.09 ... 4 MPa
Medium pressure	0 ... 30 bar	-0.9 ... 40 bar
Temperature of medium	-30 ... 230°C	-40 ... 200°C
Nominal pressure of fitting PN		16, 40
Description	<ul style="list-style-type: none"> • Highly flexible, extremely high flow rates • Long service life • Stainless steel or Ecobross process valves with stainless steel or polymer actuators • Modular design • Hygienic design, insensitive to dirt • Quick and easy maintenance • Simple and sturdy: an ideal choice for virtually all media with a viscosity of 600 mm²/s • High chemical and thermal resistance • Sustainable thanks to extended life cycle due to simplified repairability • Sustainable in production through the use of alternative materials 	<ul style="list-style-type: none"> • Sturdy design • Stainless steel and gunmetal process valves with stainless steel, brass, or aluminum actuators • Different actuator sizes and housing materials • Selection of different seat and shaft seals • For liquids, gases, and other easily contaminated media • Easy-to-clean design
online: →	vzxa	vzxf

Product overview





Process valves >

Pinch valves

	 <p>Pinch valves VZQH</p>	 <p>Pinch valves VZQA</p>
Design	Pinch valve	Pinch valve, pneumatically operated
Actuation type	Manual	Pneumatic
Valve function	2/2, closed, monostable	2/2, closed, monostable, 2/2, open, monostable
Nominal width DN	6	6, 15, 25, 50
Fitting connection	Clamp as per ASME-BPE, type A, Clamp as per DIN 32676 series A, 1/4 NPT, G1/4	Clamp as per ASME-BPE, type A, Clamp as per ASME-BPE, type B, Clamp as per DIN 32676 series A, 1/4 NPT, 1/2 NPT, 1 NPT, 2 NPT, G1, G1/2, G1/4, G2
Flow rate Kv	0.7 m3/h	0.7 ... 72 m3/h
Medium pressure [MPa]	0 ... 0.6 MPa	0 ... 0.6 MPa
Medium pressure	0 ... 6 bar	0 ... 6 bar
Medium pressure [psi]	0 ... 87 psi	0 ... 87 psi
Temperature of medium	-5 ... 100°C	-5 ... 150°C
Nominal pressure of fitting PN	10	10
Description	<ul style="list-style-type: none"> Manually operated 2/2 directional control valve for liquids, dusty media, solids and mixtures Closed at 90° lever position, secured by locking the blue safety element Automatic return to closed position (NC) when the hand lever is released by means of spring force Can be latched every 15° via the blue safety element for an even media flow Can be secured against unintentional actuation Suitable for direct food contact according to European Regulation (EC) No. 1935/2004 	<ul style="list-style-type: none"> Modular design Quick and easy replacement of the diaphragm Sustainable thanks to extended life cycle due to simplified repairability For critical, abrasive, and viscous media Easy-to-clean design Flow direction is freely selectable Versions with end-position sensing
online: →	vzqh	vzqa

Process valves >



Solenoid-actuated media valves

	 Solenoid valves VZWD-B	 Solenoid valves VZWD	 Solenoid valves VZWF	 Solenoid valves VZWM
Design	Directly controlled poppet valve	Directly controlled poppet valve	Diaphragm valve, Force pilot operated	Diaphragm valve, servo-controlled
Actuation type	Electrical	Electrical	Electrical	Electrical
Nominal width	1 ... 6.4 mm	1 ... 6 mm	13.5 ... 50 mm	13 ... 50 mm
Fitting connection	G1/8, G1/4, 1/8 NPT, 1/4 NPT	1/8 NPT, 1/4 NPT, G1/4, G1/8, NPT1/4	1/4 NPT, 3/8 NPT, 1/2 NPT, 3/4 NPT, 1 NPT, 1 1/4 NPT, 1 1/2 NPT, 2 NPT, G1, G1 1/2, G1 1/4, G1/2, G1/4, G2, G3/4, G3/8	G1, G1 1/2, G1 1/4, G1/2, G1/4, G2, G3/4, G3/8
Flow rate Kv	0.04 ... 0.64 m ³ /h	0.06 ... 0.4 m ³ /h	1.8 ... 28 m ³ /h	1.6 ... 39 m ³ /h
Medium pressure [MPa]	0 ... 10 MPa	0 ... 9 MPa	0 ... 1 MPa	
Medium pressure	0 ... 100 bar	0 ... 90 bar	0 ... 10 bar	
Medium pressure [psi]	0 ... 1450 psi	0 ... 1305 psi	0 ... 145 psi	
Temperature of medium	-10 ... 140°C	-10 ... 80°C	-10 ... 80°C	-10 ... 60°C
Description	<ul style="list-style-type: none"> • Feature-optimized • Large print area • No differential pressure necessary 	<ul style="list-style-type: none"> • Extensive pressure range • Directly actuated poppet valve • No pressure difference required • Can also be used in vacuum technology 	<ul style="list-style-type: none"> • High flow rates • Large nominal diameters with relatively small solenoids • No pressure difference required • Can also be used in vacuum technology 	<ul style="list-style-type: none"> • Brass or stainless steel casting design • Electrical connection via solenoid armature tube • Wide range of coils • Coil can be ordered separately
online: →	vzwd	vzwd	vzwf	vzwm

Product overview

Process valves >

Solenoid-actuated media valves

	 Solenoid valves, NPT VZWM	 Solenoid valves VZWP	 Media separated solenoid valves VYKA
Design	Diaphragm valve, servo-controlled	Pilot-controlled piston poppet valve	Rocker valve with diaphragm seal
Actuation type	Electrical	Electrical	Electrical
Nominal width	13 ... 50 mm	13 ... 25 mm	1.2 mm
Fitting connection	1/4 NPT, 3/8 NPT, 1/2 NPT, 3/4 NPT, 1 NPT, 1 1/4 NPT, 1 1/2 NPT, 2 NPT	1/4 NPT, 3/8 NPT, 1/2 NPT, 3/4 NPT, 1 NPT, G1, G1/2, G1/4, G3/4, G3/8	
Flow rate Kv	1.6 ... 39 m ³ /h	1.5 ... 11.5 m ³ /h	0.013 ... 0.021 m ³ /h
Medium pressure [MPa]		0.05 ... 4 MPa	-0.05 ... 0.2 MPa
Medium pressure		0.5 ... 40 bar	-0.5 ... 2 bar
Medium pressure [psi]		7.25 ... 580 psi	-7.25 ... 29 psi
Temperature of medium	-10 ... 60°C	-10 ... 80°C	
Description	<ul style="list-style-type: none"> • Brass or stainless steel casting design • Electrical connection via solenoid armature tube • Wide range of coils • Coil can be ordered separately 	<ul style="list-style-type: none"> • For all applications with a differential pressure of min. 0.5 bar • For high pressures and high flow rates with relatively small solenoids • For controlling gaseous and liquid media in open circuits 	<ul style="list-style-type: none"> • Highest power density and precision in the smallest of spaces (1.2 mm nominal width, with a width of only 7 mm) • High repeat accuracy and precision in dosing processes, even for the smallest volumes • Very easy to flush and minimized media consumption thanks to optimized fluid chamber and small internal volume • FDA-listed materials (PEEK, EPDM, FKM, FFKM) also suitable for aggressive media • Also ideal for gas applications due to minimal leakage values • Optionally with slide-on electrical sub-base VAVE-K1 with holding current reduction as accessories to minimize heat input • Developed according to ISO 13485 • Sustainable in operation through efficient control and active air shut-off
online: →	vzwm	vzwp	vyka

Process valves >



Solenoid-actuated media valves

	 Media separated solenoid valves VYKB	 Media separated solenoid valves VYKC
Design	Electrical connection at top, Electrical connection at side, Rocker valve with diaphragm seal	Electrical connection at side, Rocker valve with diaphragm seal
Actuation type	Electrical	Electrical
Nominal width	1.6 ... 2 mm	1.6 ... 2 mm
Fitting connection		
Flow rate Kv	0.034 ... 0.056 m ³ /h	0.026 ... 0.048 m ³ /h
Medium pressure [MPa]	-0.075 ... 0.3 MPa	-0.075 ... 0.3 MPa
Medium pressure	-0.75 ... 3 bar	-0.75 ... 3 bar
Medium pressure [psi]	-10.875 ... 43.5 psi	-10.875 ... 43.5 psi
Temperature of medium	0 ... 50°C	0 ... 50°C
Description	<ul style="list-style-type: none"> • Compact width of 10 mm and 12 mm for large nominal widths (1.6 mm and 2.0 mm) • For dosing, aspirating and for continuous flow applications • Very easy to clean thanks to media separation • High-quality materials, therefore also suitable for aggressive media • Developed according to ISO 13485 • Sustainable in operation through efficient control and active air shut-off 	<ul style="list-style-type: none"> • Flexible nominal widths (1.2 mm/1.6 mm/2.0 mm) with the same size (16 mm) • High-quality materials, therefore also suitable for aggressive media • Minimised heating effect thanks to intelligent holding current reduction • FDA-listed materials • Visual feedback via two LEDs simplifies use • Optionally with holding current reduction • Low energy consumption thanks to efficient control
online: →	vykb	vykc

Product overview

Process valves >

Pneumatically actuated media valves

	 Pneumatic valves VLX	 Pneumatic valves, NPT VLX	 Media separated pneumatic valves VZDB
Design	Diaphragm valve	Diaphragm valve	Rocker valve with diaphragm seal
Valve function	2/2, closed, monostable	2/2, closed, monostable	2/2, closed, monostable, 3/2, open/closed, monostable
Actuation type	Pneumatic	Pneumatic	Pneumatic
Nominal width	13 ... 25 mm	13 ... 25 mm	1.6 mm
Fitting connection	G1, G1/2, G1/4, G3/4, G3/8	NPT1, NPT1/2, NPT1/4, NPT3/4, NPT3/8	External thread/external thread
Flow rate Kv			0.034 m ³ /h
Standard nominal flow rate	2400 ... 14000 l/min	2400 ... 14000 l/min	
Temperature of medium	-10 ... 80°C	-10 ... 80°C	0 ... 50°C
Medium pressure	1 ... 10 bar	1 ... 10 bar	
Operating pressure			-0.75 ... 1 bar
Description	<ul style="list-style-type: none"> • Poppet valve • Indirectly actuated • Brass design • In-line mounting 	<ul style="list-style-type: none"> • Poppet valve • Indirectly actuated • Brass design • In-line mounting 	<ul style="list-style-type: none"> • Compact width of 10 mm • Very easy to clean thanks to media separation • High-quality materials, therefore also suitable for aggressive media • For dosing, aspirating and for continuous flow applications • Developed according to ISO 13485
online: →	vlx	vlx	vzdb

Software tools

Configurator for ball valve units KVZB



Fast, easy, safe: Dimension and order your customized ball valve units now via the configurator – without any waiting time. You will receive data sheets suitable for configuration and CAD data or CAD models to match.

You can find the configurator at
 → www.festo.com/process



Process valve units >

Ball valve units

	 <p>Ball valve units KVZB</p>
Description	<ul style="list-style-type: none"> Manually actuated with hand lever Automatically actuated with quarter turn actuator Controlled operation with quarter turn actuator and valve positioner Variants in accordance with EU Explosion Protection Directive (ATEX)
online: →	kvzb

Process valve units >



Ball valve actuator units

	 <p>Ball valve units VAPB</p>	 <p>Ball valve units VZBE</p>	 <p>Ball valve actuator units VZBM</p>
Design	2-way ball valve, Quarter turn actuator	2-way ball valve, Quarter turn actuator	3-way ball valve, Quarter turn actuator
Actuation type	Pneumatic	Pneumatic	Pneumatic
Nominal width DN	15, 20, 25, 32, 40, 50, 63	8, 10, 15, 20, 25, 32, 40, 50, 65, 80, 100	8, 10, 15, 20, 25, 32, 40, 50
Fitting connection	Rp1/4, Rp3/8, Rp1/2, Rp3/4, Rp1, Rp1 1/2, Rp1 1/4, Rp2, Rp2 1/2	1/4 NPT, 3/8 NPT, 1/2 NPT, 3/4 NPT, 1 NPT, 1 1/4 NPT, 1 1/2 NPT, 2 NPT, 2 1/2 NPT, 3 NPT, 4 NPT	Rp1, Rp1 1/2, Rp1 1/4, Rp1/2, Rp1/4, Rp2, Rp3/4, Rp3/8
Flow rate Kv	5.9 ... 535 m ³ /h	19 ... 1637 m ³ /h	
Temperature of medium	-10 ... 200°C	-10 ... 200°C	-20 ... 130°C
Nominal pressure of fitting PN	25, 40	63	25
Description	<ul style="list-style-type: none"> Ball valve actuator unit with double-acting semi-rotary valve DFPD Brass ball valve NAMUR port pattern for solenoid valves/ limit switch attachments to VDI/VDE 3845 Flow is fully opened or closed in both directions 	<ul style="list-style-type: none"> Ball valve actuator unit with double-acting semi-rotary valve DFPD Stainless steel ball valve NAMUR port pattern for solenoid valves/ limit switch attachments to VDI/VDE 3845 Flow is fully opened or closed in both directions 	<ul style="list-style-type: none"> Ball valve actuator unit with double- or single-acting quarter turn actuator DFPD Brass ball valve 2-way ball valve actuator with pipe thread in accordance with EN 10226-1 3-way ball valve actuator with drilled L-hole and pipe thread in accordance with EN 10226-1 3-way ball valve actuator with drilled T-hole and pipe thread in accordance with EN 10226-1 Flow is fully opened or closed in both directions
online: →	vapb	vzbe	vzbm

Product overview

Process valve units >

Ball valve actuator units

	 Ball valve actuator units VZBC	 Ball valve actuator units VZBA	 Ball valve actuator units VZPR
Design	2-way ball valve, Quarter turn actuator	2-way ball valve, 3-way ball valve, Drilled L hole, Quarter turn actuator, Drilled T hole	2-way ball valve, Quarter turn actuator
Actuation type	Pneumatic	Pneumatic	Electrical, Pneumatic
Nominal width DN	15, 20, 25, 32, 40, 50, 65, 80, 100	8, 10, 15, 20, 25, 32, 40, 50, 65, 80, 100	15, 20, 25, 32, 40, 50, 63
Fitting connection	Ring housing with threaded flange	Weld-on ends/weld-on ends, Rp1, Rp1 1/2, Rp1 1/4, Rp1/2, Rp1/4, Rp2, Rp2 1/2, Rp3, Rp3/4, Rp3/8, Rp4	Rp1, Rp1 1/2, Rp1 1/4, Rp1/2, Rp1/4, Rp2, Rp2 1/2, Rp3/4, Rp3/8
Flow rate Kv	19.4 ... 1414 m ³ /h	7 ... 1414 m ³ /h	
Temperature of medium	-10 ... 200°C	-10 ... 200°C	-20 ... 150°C
Nominal pressure of fitting PN	16, 40	63	25, 40
Description	<ul style="list-style-type: none"> • Ball valve actuator with double or single-acting quarter turn actuator DAPS • Stainless steel ball valve in compact design • NAMUR port pattern for solenoid valves/ limit switch attachments to VDI/VDE 3845 • Flow is fully opened or closed in both directions • Use in zone 1, 21, 2, 22 	<ul style="list-style-type: none"> • Ball valve actuator with double or single-acting quarter turn actuator DAPS • Stainless steel ball valve • NAMUR port pattern for solenoid valves/ limit switch attachments to VDI/VDE 3845 • Flow is fully opened or closed in both directions • Use in zone 1, 21, 2, 22 	<ul style="list-style-type: none"> • Ball valve actuator unit with double-acting quarter turn actuator DAPS • Brass ball valve • NAMUR port pattern for solenoid valves/ limit switch attachments to VDI/VDE 3845 • Flow is fully opened or closed in both directions
online: →	vzbc	vzba	vzpr

Software tools

Configurator for butterfly valve units KVZA



Fast, easy and safe: Dimension and order your customized butterfly valve units now via the configurator – without any waiting time.

You will receive data sheets suitable for configuration and CAD data or CAD models to match.

You can find the configurator at
 → www.festo.com/process

Process valve units >

Butterfly valve units



Actuated butterfly valves
KVZA

Description	<ul style="list-style-type: none"> • For versatile use in various industry sectors • Manually actuated with hand lever • Automatically actuated with quarter turn actuator • Controlled operation with quarter turn actuator and valve positioner • Butterfly valve type: wafer or lug • Nominal width DN25 ... DN200 • Connection standard DIN EN 1092-1 or ANSI CLASS 150
online: →	kvza

Dispense and pipette heads >

Dispense heads



Dispense heads
VTOE

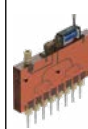

Dispense heads
VTOI

	Dispense heads VTOE	Dispense heads VTOI
Valve function	2/2, closed, monostable	2/2, closed, monostable
Width dimension	9 mm	9 mm
Operating pressure	0 bar, 0.5 bar	-0.2 bar, 0 bar, 0.65 bar, 1 bar
Internal volume	113 µl valve with fluid connections	10 µl fluid space valve, 178 µl distributor block with valve, needle and fittings
Fluid connection	8x UNF1/4-28, UNF1/4-28	Internal thread 1/4-28 UNF-2B
Medium	Liquid media	Liquid media, Gaseous media
Materials in contact with the media	ETFE, FFPM, FPM, PC, PEEK, PPS, High-alloy stainless steel	ETFE, FPM, PEI, PPS, High-alloy stainless steel
Nominal width of dosing needle	0.32 mm, 0.6 mm, 1 mm	0.3 mm
Ambient temperature	5 ... 40°C	5 ... 40°C
Description	<ul style="list-style-type: none"> • Basic function: dosing • Ready-to-install dosing solution saves time and costs • Compact 9 mm width dimension • Suitable for sensitive and aggressive liquids • Ideally suited to non-contact dosing of liquid media • Maximum dosing precision down to the microliter range • Small internal volume makes it easy to rinse • 1 or 8-channel dispense head • Typical coefficient variation (CV): < 1% at 10 to 1000 µl 	<ul style="list-style-type: none"> • One valve control for distribution into 8 dispensing channels • Grid size 9 mm – ideal for microwell plates • Simple design with side-by-side mounting for increased throughput • Just a few components needed for a complete system • Suitable for aggressive liquids
online: →	vtoe	vtoi

Product overview

Dispense and pipette heads >

Accessories for dispense heads



Valve control modules
VAEM

Dimensions (W x L x H)	92 mm x 100 mm x 28 mm
Parameterization	Parameter setting per output
Max. no. of outputs	8
Inrush current, per output	20 ... 1000 mA
Holding current, per output	20 ... 400 mA
Inrush current, total	4 A
Holding current, total	1.8 A
Trigger level	Level 14 V ... 24 V
Time resolution	0.2 ms
Communication interface, protocol	ASCII via RS232
Ethernet interface, protocol	Modbus® TCP
Description	<ul style="list-style-type: none"> • Electronic control with integrated, adjustable holding current reduction for controlling up to 8 solenoid valves • Parameterization, diagnostics and control via graphical user interface (GUI), Ethernet and RS232 interface as well as external 24 V trigger input • Graphical user interface (GUI) for the easiest possible operation and clear visualization • Very fast valve control with a temporal resolution of 0.2 ms • Easy setting of a calibration factor between the individual channels (opening times per valve)
online: →	vaem

Dispense and pipette heads >

Accessories for dispense heads





Dosing elements
VAVN



Disposable tips
DHAP



Design		Pipette tip holder for 20...1000 µl single-use tips from Festo
Operating pressure [MPa]	0 ... 0.4 MPa	
Flow rate Kv	0.003 ... 0.039 m³/h	
Medium	Liquid media, Gaseous media	
Materials in contact with the media	High-alloy stainless steel	
Ambient temperature	5 ... 60°C	5 ... 40°C
Description	<ul style="list-style-type: none"> • For dosing applications with the highest precision • Length of dosing needle 30 mm or 60 mm • Outside diameter 1.6 mm • Nominal width 0.3 mm, 0.6 mm or 1.2 mm • High corrosion resistance (corrosion resistance class CRC 3 to Festo standard 940 070) • Design with chamfer and/or with taper • Pack of 10 	<ul style="list-style-type: none"> • Volume: 20, 300, 1000 µl • Disposable tip material: polypropylene (clear, not colored) • Filter material: polyethylene (white) • Optional: sterile packaging • Delivered stacked or in a framework • Packaging unit: 960 pieces
online: →	vavn	dhap

Piezo valves





	 Piezo valve VEVP	 Proportional flow control valves VEMD	 Proportional pressure control valves VEAA
Valve function	3-way proportional pressure control valve closed	2-way proportional flow control valve	3-way proportional pressure control valve
Standard nominal flow rate		50 ... 200 l/min	≥7 l/min
Operating pressure [MPa]	0.2 ... 0.7 MPa	0 ... 0.6 MPa	
Operating pressure	2 ... 7 bar	0 ... 6 bar	
Pneumatic connection 1	Flange	Internal thread G1/4, Female thread M5	Flange, QS-4
Nominal width	4 mm	1.4 ... 6 mm	
Nominal operating voltage DC	24 V	12 ... 24 V	24 V
Control range		0 ... 200 l/min	0.001 ... 1 MPa
Description	<ul style="list-style-type: none"> • Developed for valve terminal VTEP • High precision with very low power consumption • Valve status display via LED • 4 Piezo valves in a bridge circuit for precise control • Available in two versions: Standard and low pressure • Easy to replace thanks to screw fastening on the connecting plate 	<ul style="list-style-type: none"> • Mass flow controller (MFC) with thermal flow rate sensor and integrated control electronics • Dynamic regulation with short response time • Operating medium: air, oxygen, nitrogen, argon, CO₂ • The current flow rate value is available via the interface • Ideal for many applications where inert gases or oxygen need to be controlled • Sustainable operation due to efficient control 	<ul style="list-style-type: none"> • High precision up to 10 bar • Very compact size • Highly dynamic pressure control for very low flow rates • Available as a pipe socket or sub-base valve • Silent operation and low heat generation • Very short switching times • Sustainable operation due to lower pressure level and efficient control
online: →	vevp	vemd	veaa

Product overview

Piezo valves



	 Proportional pressure control valves VEAB	 Valves VEVM
Valve function	3-way proportional pressure control valve, 3-way proportional pressure control valve closed	Can be assigned using Motion App
Standard nominal flow rate	≥4.5 l/min	
Operating pressure [MPa]		0.3 ... 0.8 MPa
Operating pressure		3 ... 8 bar
Pneumatic connection 1	Flange, QS-4, QS-4	G3/8
Nominal width		4.2 mm
Nominal operating voltage DC	24 V	24 V
Control range	-0.1 ... 0.6 MPa	
Description	<ul style="list-style-type: none"> • Control vacuum and/or overpressure with a single valve • Highly dynamic pressure control for low flow rates • Highest performance and optionally available with IO-Link® interface • Available as a pipe socket or sub-base valve • Additional IO-Link® features: customizable control parameters, diagnostics, 2-point calibration, etc. • Silent operation and low heat generation • Very short switching times • Sustainable operation due to lower pressure level and efficient control 	<ul style="list-style-type: none"> • Functionality assignable via Motion app • For Motion Terminal VTEM • Consisting of 4 wired piezo pilot-controlled piston seat valves • Extremely long service life • Very low power consumption • Low leakage with the function of a proportional pressure regulator
online: →	veab	vevm

Pneumatic control systems

	 Control blocks for two-hand start ZSB	 Pneumatic counters, M5 Compact System PZA, PZV	 Timers, M5 Compact System PZVT	 Electric counters CCES
Design		Mechanical sequence counter with pneumatic actuator	Mechanical sequence counter with pneumatic actuator	Electrical adding counter with battery
Actuation type	Pneumatic			
Pneumatic connection		M5	Female thread M5	
Pneumatic connection 2	G1/8			
Type of mounting	Optionally, With through-hole, With internal thread	Front panel mounting, With through-hole	Front panel mounting	Front panel mounting
Operating pressure	4 ... 8 bar	2 ... 8 bar	2 ... 6 bar	
Performance Level (PL)	Two-hand control/category 1, performance level c			
Description	<ul style="list-style-type: none"> Used wherever manual actuation poses a risk of accident to operating personnel With safety functions 	<ul style="list-style-type: none"> Complete system offering control elements with all the functions required for pneumatic sequence controls For control cabinet installation Fast replacement of components Available with protective cap 	<ul style="list-style-type: none"> Complete system offering control elements with all the functions required for pneumatic sequence controls For control cabinet installation Fast replacement of components Mechanical sequence counter with pneumatic actuator Adjustable delay time Available with protective cap 	<ul style="list-style-type: none"> 8-digit LCD display Independent power supply Connection via terminal strip Reset button
online: →	zsb	pza	pzvt	cces

Accessories for pneumatic valves >

Function components

	 Vacuum blocks VABF-S4-1-V2B1	 Vacuum generators VABF-S4-2-V2B1
Width		35 mm
Nominal width of Laval nozzle	2 mm	1.4 mm, 2 mm, 3 mm
Ejector characteristics	High vacuum, Standard	High suction rate, High vacuum, Standard
Integrated function	Ejector pulse valve, electric, Flow control, On/off valve, electric, Air saving function, electrical, Non-return valve, Pneumatic muffler open, Vacuum switch	Electric ejector pulse, Flow control, On/off valve, electric, Air saving function, electrical, Power ejector pulse valve, electric, Non-return valve, Pneumatic muffler open, Vacuum switch
Max. vacuum		0.092 MPa
Display type		LED, LED display, 2-digit
Description	<ul style="list-style-type: none"> In conjunction with a suction gripper to pick up, hold and place components Can be integrated in valve terminal VTSA, VTSA-F With air saving function and adjustable ejector pulse 	<ul style="list-style-type: none"> In conjunction with a suction gripper to pick up, hold and place components Can be integrated in valve terminal VTSA-F-CB With air saving function and adjustable ejector pulse Variants with high vacuum or high suction volume flow Variants with energy- and air-saving power ejector pulse
online: →	vabf-s4	vabf-s4

Product overview

Customized components – for your specific requirements

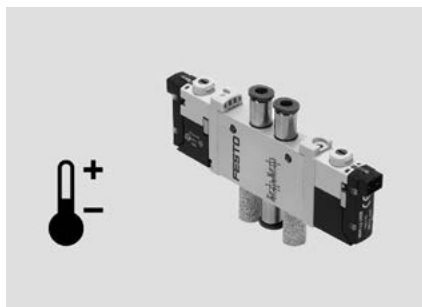

Valves with customized designs

Can't find the valve you need in our catalog?

We can offer you customized components that are tailored to your specific requirements.

Common product modifications:

- Coatings for special ambient conditions
- Customized cables: length, pin allocation, pre-assembled with plug
- Modified actuating elements
- Modified connecting thread
- Modified valve sub-bases

Many additional variants are possible.

Ask your Festo sales engineer, who will be happy to help:

→ www.festo.com/contact

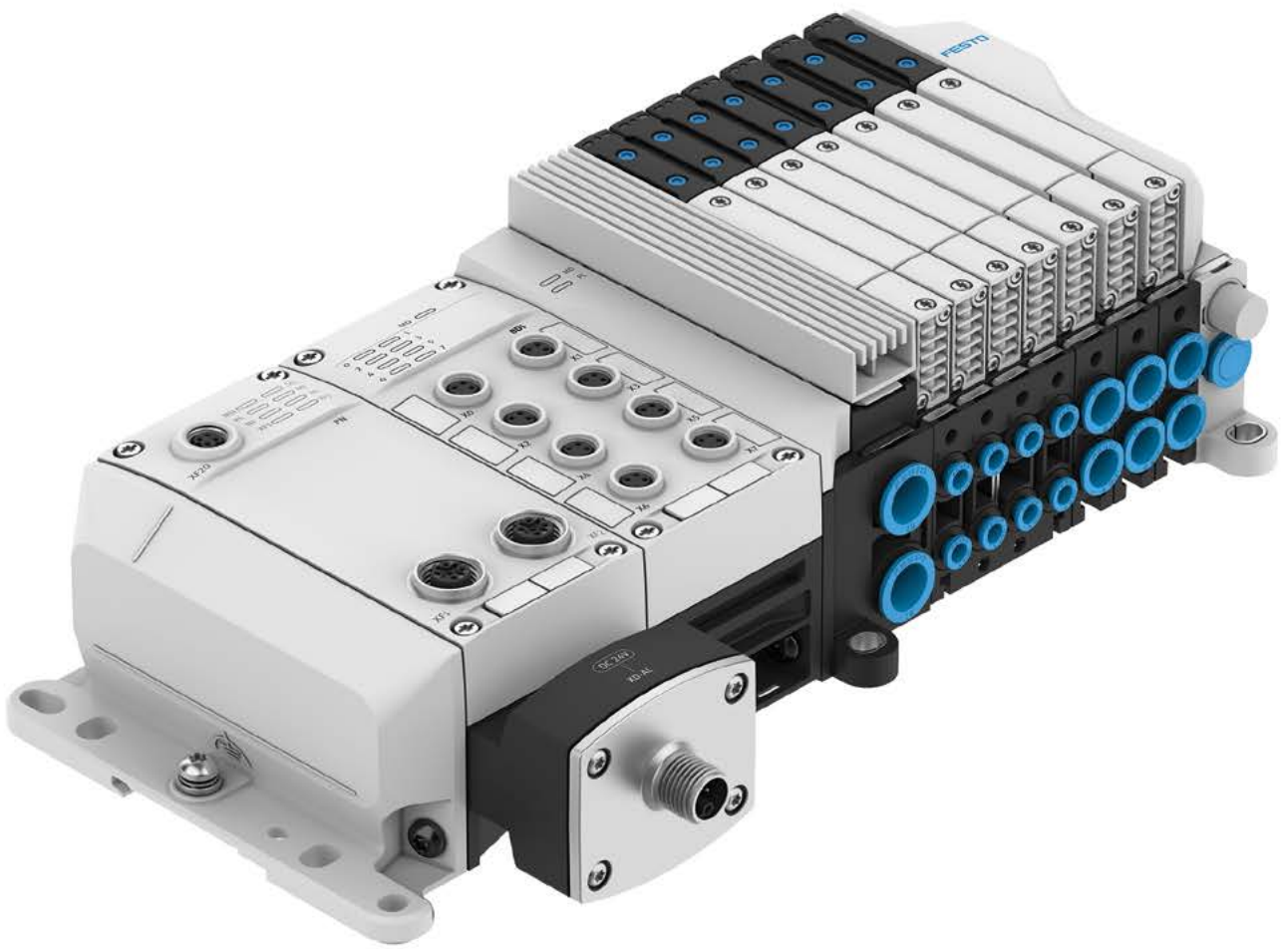

Product overview

Software tools

Configurator for valve terminals

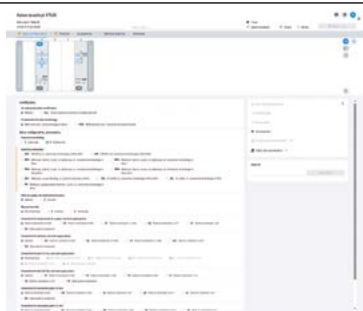

Design a product with a number of features quickly and reliably with the help of the configurator.

Select all the required product features step-by-step. The use of logic checks ensures that only correct configurations are available for selection.



A dynamic graphic generated based on the configuration provides visual assistance in selecting the correct product features.

You can find the configurator for your product at

1. www.festo.com/catalogue > Valves and valve terminals > Valve terminals
2. Select your desired product
3. Click on the blue „Configure product“ button



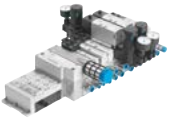

Industry standard valve manifolds

Standards-based valve terminals

	 Valve manifolds VTSA	 Valve manifolds VTSA-NPT	 Manifold assemblies, to ISO 15407-1 VTIA
Valve size	18 mm, 26 mm, 42 mm, 52 mm, 65 mm	18 mm, 26 mm, 42 mm, 52 mm, 65 mm	18 mm, 26 mm
Pneumatic working port	1/8 NPT, 1/4 NPT, 3/8 NPT, 1/2 NPT, G1, G1/2, G1/4, G1/8, G3/8, QS-1/2, QS-10, QS-12, QS-14, QS-16, QS-3/8, QS-5/16, QS-6, QS-8	1/8 NPT, 1/8 NPTF, 1/4 NPT, 3/8 NPT, 1/2 NPT, 1 1/2 NPT, QS-10, QS-12, QS-16, QS-6, QS-8	G1/2, G1/4, G1/8, G3/8, QS-10, QS-12, QS-16, QS-8
Valve function	2x2/2 closed, monostable, 2x3/2, closed, monostable, 2x3/2, open, monostable, 2x3/2, open/closed, monostable, 5/2, bistable, 5/2, bistable, dominant, 5/2, monostable, 5/2, monostable, safety function, 5/3, pressurized, 5/3, exhausted, 5/3, closed, 5/3, connection 2 pressurized, 4 exhausted	2x2/2 closed, monostable, 2x3/2, closed, monostable, 2x3/2, open, monostable, 2x3/2, open/closed, monostable, 5/2, bistable, 5/2, bistable, dominant, 5/2, monostable, 5/2, monostable, safety function, 5/3, pressurized, 5/3, exhausted, 5/3, closed, 5/3, connection 2 pressurized, 4 exhausted	2x3/2, closed, monostable, 2x3/2, open, monostable, 2x3/2, open/closed, monostable, 5/2, bistable, 5/2, bistable, dominant, 5/2, monostable, 5/3, pressurized, 5/3, exhausted, 5/3, closed
Max. standard nominal flow rate	550 l/min at 18 mm, 700 l/min at 18 mm, 1100 l/min at 26 mm, 1300 l/min at 42 mm, 1350 l/min at 26 mm, 1860 l/min at 42 mm, 2900 l/min at 52 mm, 4000 l/min at 65 mm	550 l/min at 18 mm, 1100 l/min at 26 mm, 1300 l/min at 42 mm, 2900 l/min at 52 mm, 4000 l/min at 65 mm	550 l/min at 18 mm, 1100 l/min at 26 mm
Max. no. of valve positions	32	32	16
Max. no. of pressure zones	32	32	3
Electrical actuation	AP interface, Ethernet, Fieldbus, IO-Link®, Multi-pin, Integrated controller	AP interface, Ethernet, Fieldbus, IO-Link®, Multi-pin, Integrated controller	Individual connection
Valve manifold design	Modular, pneumatic valve sizes can be mixed	Modular, pneumatic valve sizes can be mixed	Modular, pneumatic valve sizes can be mixed
Description	<ul style="list-style-type: none"> • Conforms to ISO 15407-2/ISO 5599-2 • Multi-pin plug connection or fieldbus connection via the CPX system • Five pneumatic valve sizes can be combined on one valve manifold • Integratable safety functions 	<ul style="list-style-type: none"> • Conforms to ISO 15407-2/ISO 5599-2 • Multi-pin plug connection or fieldbus connection via the CPX system • Five pneumatic valve sizes can be combined on one valve manifold • Integratable safety functions 	<ul style="list-style-type: none"> • Conforms to ISO 15407-1 • Wide range of individual electrical connections • Two valve sizes can be combined: ISO size 01/26 mm and ISO size 02/18 mm • Standardized electrical connection: type C square plug or individual connection with M8/M12 central plug
online: →	vtsa	vtsa	vtia

Universal valve manifolds





Universal valve terminals

	 Valve terminals VTUX-A-P	 Manifold assemblies VTUG-S	 Valve manifolds with multi-pin plug/fieldbus connection VTUG	 Valve manifold VTUG-EX with multi-pin plug, fieldbus interface VTUG-EX
Valve size	10 mm	10 mm, 14 mm, 18 mm	10 mm, 14 mm, 18 mm	10 mm, 14 mm, 18 mm
Valve function	2x3/2, closed, monostable, 2x3/2, open, monostable, 2x3/2, open/closed, monostable, 5/2, bistable, 5/2, monostable, 5/3, closed, 5/3-way valve, with holding function, for vacuum switching unit, 5/4-way valve, with holding function, for vacuum generator, 5/4 closed, 2 or 4 exhausted	2x3/2, closed, monostable, 2x3/2, open, monostable, 2x3/2, open/closed, monostable, 5/2, bistable, 5/2, monostable, 5/3, pressurized, 5/3, exhausted, 5/3, closed	2x3/2, closed, monostable, 2x3/2, open, monostable, 2x3/2, open/closed, monostable, 3/2, closed, monostable, 3/2, open, monostable, 5/2, bistable, 5/2, monostable, 5/3, pressurized, 5/3, exhausted, 5/3, closed	2x3/2, closed, monostable, 2x3/2, open, monostable, 2x3/2, open/closed, monostable, 3/2, closed, monostable, 3/2, open, monostable, 5/2, bistable, 5/2, monostable, 5/3, pressurized, 5/3, exhausted, 5/3, closed
Max. standard nominal flow rate		380 l/min at 10 mm, 780 l/min at 14 mm, 1380 l/min at 18 mm	330 l/min at 10 mm, 630 l/min at 14 mm, 1200 l/min at 18 mm	330 l/min at 10 mm, 630 l/min at 14 mm, 1200 l/min at 18 mm
Max. no. of valve positions	32, 64	16	24	24
Max. no. of pressure zones	16	9	13	13
Electrical actuation		Individual connection	AP interface, Individual connection, Fieldbus, I-Port, IO-Link®, Multi-pin	Fieldbus, I-Port, IO-Link®, Multi-pin
Valve manifold design	Modular and expandable	Fixed grid	Fixed grid	Fixed grid
Description	<ul style="list-style-type: none"> • Flexible for centralized and decentralized installation • Compact, lightweight yet robust • Modular and cost-effective • High flow rate • Versatile options for creating pressure zones 	<ul style="list-style-type: none"> • Compact with small pneumatic valves VUVG • Connection technology easy to change via the E-box • Wide range of valve functions • Also with semi in-line valves 	<ul style="list-style-type: none"> • Low-cost fixed grid • Extremely easy assembly • Exchangeable electrical actuation • IO-Link® capable • Pneumatic valves VUVG with individual electrical connection can be integrated • Also available with pneumatic multiple connector plate • Part of the VG series • Energy-efficient thanks to reverse operation and targeted pressure reduction • Optimized, space-saving variant available for installation in control cabinets • Variants with hot swap connections: pneumatic valves can be replaced during ongoing process • Variants recommended for production facilities for the manufacture of lithium-ion batteries 	<ul style="list-style-type: none"> • As per EU explosion protection directive (ATEX) • Stainless-steel-coated terminal strips for extreme corrosion resistance, suitable for control cabinets and environments up to IP69k
online: →	vtux	vtug	vtug	vtug

Product overview



Universal valve manifolds

Universal valve terminals

	 Valve terminal with multi-pin, fieldbus interface VTUG-F1A	 Manifold assemblies VTUS	 Valve manifolds MPA-L	 Valve manifolds MPA-S
Valve size	10 mm, 14 mm	21 mm, 26.5 mm, 31 mm	10 mm, 14 mm, 20 mm	10 mm, 14 mm, 20 mm
Valve function	2x3/2, closed, monostable, 2x3/2, open, monostable, 2x3/2, open/closed, monostable, 3/2, closed, monostable, 3/2, open, monostable, 5/2, bistable, 5/2, monostable, 5/3, pressurized, 5/3, exhausted, 5/3, closed	2x3/2, closed, monostable, 2x3/2, open, monostable, 2x3/2, open/closed, monostable, 3/2, closed, monostable, 3/2, open, monostable, 5/2, bistable, 5/2, monostable, 5/3, pressurized, 5/3, exhausted, 5/3, closed	2/2, closed, monostable, 2x3/2, closed, monostable, 2x3/2, open, monostable, 2x3/2, open/closed, monostable, 3/2, closed, monostable, 3/2, open, monostable, 5/2, bistable, 5/2, monostable, 5/3, pressurized, 5/3, exhausted, 5/3, closed	2/2, closed, monostable, 2x3/2, closed, monostable, 2x3/2, open, monostable, 2x3/2, open/closed, monostable, 3-way proportional pressure control valve, 3/2, closed, monostable, 3/2, open, monostable, 5/2, bistable, 5/2, monostable, 5/3, pressurized, 5/3, exhausted, 5/3, closed
Max. standard nominal flow rate	330 l/min at 10 mm, 630 l/min at 14 mm		360 l/min at 10 mm, 670 l/min at 14 mm, 870 l/min at 20 mm	360 l/min at 10 mm, 550 l/min at 14 mm, 700 l/min at 20 mm
Max. no. of valve positions	24	16	32	24, 64, 8
Max. no. of pressure zones	13	9	20	3, 7, 17
Electrical actuation	AP interface, I-Port, IO-Link®, Multi-pin	Individual connection	Fieldbus, I-Port, IO-Link®, Multi-pin	AP interface, AS-Interface, Fieldbus, Multi-pin
Valve manifold design	Fixed grid	Fixed grid	Valve sizes can be mixed	Modular, pneumatic valve sizes can be mixed
Description	<ul style="list-style-type: none"> Recommended for production systems for the manufacture of Li-ion batteries (F1A) Low-cost fixed grid Extremely easy assembly Exchangeable electrical actuation IO-Link® capable Part of the VG series Energy-efficient thanks to reverse operation and targeted pressure reduction 	<ul style="list-style-type: none"> Robust pneumatic valves VUUS with long service life Individual electrical connection Pilot air supply in the manifold rail Comprehensive range of accessories 	<ul style="list-style-type: none"> Maximum modularity System can be extended as required with individual sub-bases and modular tie rods Polymer sub-bases 3 pneumatic valve sizes Tamper-proof fixed flow restrictor Fieldbus connection via CPX IO-Link® capable 	<ul style="list-style-type: none"> Valve manifolds for universal applications High-performance valves in a sturdy metal housing Metal linking Two valve sizes can be combined Excellent communication thanks to serial linking Fieldbus connection via CPX Max. 128 pneumatic valves
online: →	vtug-f1a	vtus	mpa-l	mpa-s

Universal valve manifolds

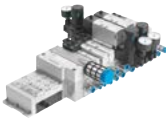

Universal valve terminals

	 Valve manifolds VTSA-F	 Valve manifolds VTSA-F-CB	 Valve manifolds VTSA-F-NPT
Valve size	18 mm, 26 mm, 42 mm, 52 mm, 65 mm	18 mm, 26 mm, 42 mm, 52 mm	18 mm, 26 mm, 42 mm, 52 mm, 65 mm
Valve function	2x2/2 closed, monostable, 2x3/2, closed, monostable, 2x3/2, open, monostable, 2x3/2, open/closed, monostable, 5/2, bistable, 5/2, bistable, dominant, 5/2, monostable, 5/2, monostable, safety function, 5/3, pressurized, 5/3, exhausted, 5/3, closed, 5/3, connection 2 pressurized, 4 exhausted	2x2/2 closed, monostable, 2x3/2, closed, monostable, 2x3/2, open, monostable, 2x3/2, open/closed, monostable, 5/2, bistable, 5/2, bistable, dominant, 5/2, monostable, 5/3, pressurized, 5/3, exhausted, 5/3, closed, 5/3, connection 2 pressurized, 4 exhausted	2x2/2 closed, monostable, 2x3/2, closed, monostable, 2x3/2, open, monostable, 2x3/2, open/closed, monostable, 5/2, bistable, 5/2, bistable, dominant, 5/2, monostable, 5/2, monostable, safety function, 5/3, pressurized, 5/3, exhausted, 5/3, closed, 5/3, connection 2 pressurized, 4 exhausted
Max. standard nominal flow rate	700 l/min at 18 mm, 1350 l/min at 26 mm, 1860 l/min at 42 mm, 2900 l/min at 52 mm, 4000 l/min at 65 mm	700 l/min at 18 mm, 1350 l/min at 26 mm, 1860 l/min at 42 mm, 2900 l/min at 52 mm	700 l/min at 18 mm, 1350 l/min at 26 mm, 1860 l/min at 42 mm, 2900 l/min at 52 mm, 4000 l/min at 65 mm
Max. no. of valve positions	32		32
Max. no. of pressure zones	16		16
Electrical actuation	AP interface, Ethernet, Fieldbus, IO-Link®, Multi-pin, Integrated controller	Ethernet, Fieldbus, Integrated controller	AP interface, Ethernet, Fieldbus, IO-Link®, Multi-pin, Integrated controller
Valve manifold design	Modular, pneumatic valve sizes can be mixed	Modular, pneumatic valve sizes can be mixed	Modular, pneumatic valve sizes can be mixed
Description	<ul style="list-style-type: none"> Flow rate-optimized valve manifold VTSA Linking with increased flow rates Functions like industry standard valve manifolds VTSA 	<ul style="list-style-type: none"> Valve terminal VTSA optimized for flow rate and communication Extended diagnostic functions via CBUS and LED display Previous external cabling is now unnecessary – yet the installation space remains the same Up to 96 valve addresses and up to four voltage zones, three of which can be safely shut down For applications with heightened safety requirements such as manual work stations Control via CPX pneumatic interface with serial communication Five pneumatic valve sizes can be combined on one valve manifold 	<ul style="list-style-type: none"> Flow rate-optimized valve manifold VTSA Linking with increased flow rates Functions like industry standard valve manifolds VTSA
online: →	vtsa	vtsa-f	vtsa

Product overview



Universal valve manifolds

Universal valve terminals

	 Valve manifolds CPV-SC	 Valve manifolds, Compact Performance CPV10, CPV14, CPV18	 Manifold assemblies, Compact Performance CPV10-EX-I
Valve size	10 mm	10 mm, 14 mm, 18 mm	10 mm
Valve function	2/2, closed, monostable, 3/2, closed, monostable, 3/2, open, monostable, 5/2, bistable, 5/2, monostable	2x2/2 closed, monostable, 2x2/2, open/closed, monostable, 2x3/2, closed, monostable, 2x3/2, open, monostable, 2x3/2, open/closed, monostable, 5/2, bistable, 5/2, monostable, Vacuum generator, Vacuum generator + 2/2, closed, monostable	2x2/2 closed, monostable, 2x2/2, open/closed, monostable, 2x3/2, closed, monostable, 2x3/2, open, monostable, 2x3/2, open/closed, monostable, 5/2, bistable, 5/2, monostable, 5/3, closed
Max. standard nominal flow rate	170 l/min at 10 mm	400 l/min at 10 mm, 800 l/min at 14 mm, 1600 l/min at 18 mm	400 l/min at 10 mm
Max. no. of valve positions	16	8	8
Max. no. of pressure zones	8	2	2
Electrical actuation	CPI installation system, Individual connection, Multi-pin	AS-Interface, CPI installation system, Individual connection, Fieldbus, Multi-pin	Individual connection
Valve manifold design	Fixed grid	Fixed grid	Fixed grid
Description	<ul style="list-style-type: none"> • Small and compact • High flow rate even with compact design • Suitable for vacuum • Multi-pin or fieldbus control 	<ul style="list-style-type: none"> • Maximum performance in the smallest of spaces • Three sizes • Wide range of connection and mounting options • Multi-pin or fieldbus control • IO-Link® capable 	<ul style="list-style-type: none"> • Intrinsically safe valve manifold design to ATEX Category 2 (zone 1) • Optimized for control cabinet assembly • Optimal for pilot control of process valves
online: →	cpv-sc	cpv	cpv10-ex



Application-specific valve manifolds

Application-specific valve terminals



	 Valve manifolds MPA-C	 Valve manifolds VTOC	 Valve manifolds MH1
Valve size	14 mm	10 mm	10 mm
Width dimension	26.8 mm		
Valve function	2/2, closed, monostable, 2x3/2, closed, monostable, 2x3/2, open, monostable, 2x3/2, open/closed, monostable, 3/2, closed, monostable, 3/2, open, monostable, 5/2, bistable, 5/2, monostable, 5/3, pressurized, 5/3, exhausted, 5/3, closed	2x3/2, closed, monostable	2/2, closed, monostable, 3/2, closed, monostable, 3/2, open, monostable
Max. standard nominal flow rate	780 l/min at 14 mm	10 l/min at 10 mm	10 l/min at 10 mm
Operating pressure [MPa]	-0.09 ... 0.8 MPa	0 ... 0.8 MPa	
Operating pressure	-0.9 ... 8 bar	0 ... 8 bar	-0.9 ... 8 bar
Operating pressure [psi]	-13.05 ... 116 psi	0 ... 116 psi	
Electrical actuation	I-Port, IO-Link®, Multi-pin	I-Port, IO-Link®, Multi-pin	Individual connection, Multi-pin
Nominal operating voltage DC	24 V	24 V	5 V, 12 V, 24 V
Max. no. of valve positions	32	24	24
Valve manifold design	Modular and expandable	Fixed grid	Fixed grid
Description	<ul style="list-style-type: none"> • Valve manifolds in Clean Design • Easy-to-clean design • High corrosion resistance • Degree of protection IP69K • FDA-compliant materials • Redundant sealing system 	<ul style="list-style-type: none"> • Compact pilot valves • Compact assembly • Greater safety thanks to interlock function • Multi-pin or fieldbus control • IO-Link® capable 	<ul style="list-style-type: none"> • Miniaturized poppet valves • Multi-pin or electrical individual connection
online: →	mpa-c	vtoc	mh1

Product overview

Application-specific valve manifolds

	 Dispense heads VTOE	 Dispense heads VTOI
Width dimension	9 mm	9 mm
Valve function	2/2, closed, monostable	2/2, closed, monostable
Nominal width	0.8 mm	0.8 mm
Nominal width of dosing needle	0.32 ... 1 mm	0.3 mm
Length of dosing needle	30 mm	30 mm
Operating pressure [MPa]	0 ... 0.05 MPa	-0.02 ... 0.1 MPa
Operating pressure	0 ... 0.5 bar	-0.2 ... 1 bar
Operating pressure [psi]	0 ... 7.25 psi	-2.9 ... 14.5 psi
Electrical connection	2-wire, 9-pin, Cable, Plug, Sub-D, Open end	2-wire, 2x single wires, Open end
Nominal operating voltage DC	24 V	24 V
Description	<ul style="list-style-type: none"> • Basic function: dosing • Ready-to-install dosing solution saves time and costs • Compact 9 mm width dimension • Suitable for sensitive and aggressive liquids • Ideally suited to non-contact dosing of liquid media • Maximum dosing precision down to the microliter range • Small internal volume makes it easy to rinse • 1 or 8-channel dispense head • Typical coefficient variation (CV): < 1% at 10 to 1000 µl 	<ul style="list-style-type: none"> • One valve control for distribution into 8 dispensing channels • Grid size 9 mm – ideal for microwell plates • Simple design with side-by-side mounting for increased throughput • Just a few components needed for a complete system • Suitable for aggressive liquids
online: →	vtoe	vtoi

Application-specific valve manifolds

	 Valve manifold VTEP	 Valve manifolds VTOP
Size		100 mm
Width dimension	16 mm	
Variants		Manifold block for safety functions, HFT0 prepared for exhaust, VDI/VDE 3845, Manifold block for safety functions, HFT0 prepared for exhaust, VDI/VDE 3847, Manifold block for safety functions, HFT1 prepared for exhaust, VDI/VDE 3847, End plate, double-acting, active direction, can be switched, Filter regulator, pressure range 0.5 ... 12 bar, grade of filtration 40 µm, Filter regulator, pressure range 0.5 ... 12 bar, grade of filtration 5 µm, Module for reaching a specific end position in case of a pressure failure, Volume booster, double-acting, Volume booster, single-acting
Operating pressure [MPa]	0.2 MPa, 0.7 MPa	0 MPa, 0.9 MPa
Operating pressure	2 bar, 7 bar	0 bar, 9 bar
Operating pressure [psi]	29 psi, 101.5 psi	0 psi, 130.5 psi
Pneumatic connection		Sub-base design, airing
Description	<ul style="list-style-type: none"> • Proportional valve terminal with piezo technology • Very compact: 10 channels on a width of less than 120 mm • Highly dynamic and precise control of pressure and vacuum • Very flexible: customizable control parameters • Digital communication interface EtherCAT • Very low power consumption • No wear and tear, no emissions • Silent operation • Sustainable operation due to efficient control 	<ul style="list-style-type: none"> • Innovative, modular, compact complete solution for control applications • Modules such as fail-safe, volume booster and filter regulator can be combined with one another as desired, are easy to install, and can be extended and retrofitted without any problems • Patented integrated air ducting to supply all modules as well as actuator and positioner, without leak-prone, external pipework • Standardized mounting interface for direct attachment of a positioner according to VDI/VDE 3847-2 • Optimized for positioner CMSH for controlling single and double-acting quarter turn and linear drives • Suitable for quarter turn actuators DFPD-C with mechanical interface according to VDI/VDE 3847-2 and for linear drives DFPI-NB3 based on ISO 15552 • Sustainable in operation due to leakage reduction at sealing points
online: →	vtep	vtop

Product overview

Software tools

Automation Suite commissioning software



Quickly and reliably to a ready-to-use drive system – the Festo Automation Suite combines the parameterization, programming and maintenance of complete drive systems from the mechanical to the control system – and all with just one software. Perfect for making industrial automation simple, efficient and consistent.

Plug-in automation system CPX-E

- Controller programming in CODESYS as a system expansion for applications ranging from SoftMotion to robotics
 - Just two mouse clicks instead of 100: greatly simplified integration of the servo drive CMMT-AS into the control program with CPX-E-CEC
 - Conveniently install the plug-in using the software
- You can find this tool on the Internet at

→ www.festo.com/AutomationSuite

Connectivity Finder





This tool can be used to find the optimum way to connect a Festo solution to your preferred (non-Festo) controller. You will also be provided with expert knowledge for your selected connection option, making it really easy to integrate the Festo solution into your machine.

This tool can be found at



→ www.festo.com/x/connectivity-finder

Electrical peripherals



	 Terminals CPX	 Remote I/O systems CPX-AP-A
Protocol		ACD (Address Conflict Detection), AP, DLR (Device Level Ring), EtherCAT, EtherCAT CoE, EtherCAT Distributed Clocks (DC), EtherCAT EoE, EtherCAT FoE, EtherCAT Modular Device Profile (MDP), EtherNet/IP, EtherNet/IP QoS, EtherNet/IP Quickconnect, LLDP, MRP, MRPD (ring redundancy), Modbus/TCP (Modbus/UDP), PROFINET FSU, PROFINET I&MO .. 3, PROFINET IRT, PROFINET RT, PROFINET Shared device, S2 system redundancy, SNMP
Electrical actuation	Fieldbus, Integrated controller	AP interface, Ethernet
Max. address capacity, inputs	64 byte	1024 ... 4096 byte
Maximum address volume for outputs	64 byte	1024 ... 4096 byte
Parameterization	Diagnostic behavior, Fail-safe response, forcing of channels, Signal setup	
Degree of protection	IP65, IP67	IP65, IP67
Nominal operating voltage DC	24 V	
DC operating voltage range	18 ... 30 V	
Description	<ul style="list-style-type: none"> Automation platform Open to all common fieldbus protocols and Ethernet Integrated diagnostic and maintenance functions Can be used as stand-alone remote I/O or with valve manifolds MPA-S, MPA-L, VTSA/VTSA-F Interlinking block in either polymer or metal with individual linking Analog inputs and outputs, 2-way/4-way, with optional HART protocol 	<ul style="list-style-type: none"> Modular and lightweight IO system in IP65/IP67 Highly flexible remote IO system with maximum performance Can be expanded and easily combined with CPX-AP-A and CPX-AP-I to form an integrated system End-to-end connectivity with extended diagnostics option increases machine availability and productivity Simple integration into the controller of your choice: PROFINET, PROFIBUS, EtherCAT®, EtherNet/IP, ModbusTCP, Profibus Module for IO-Link® available Fits perfectly into our holistic product portfolio of electromechanical actuators, motors, drive controllers and control systems High-performance remote I/O system that flexibly networks 80 modules in real time with a 200 Mbaud data rate Sustainable in operation due to energy shutdown
online: →	cpx	cpx-apa

Product overview

Electrical peripherals



	 <p>Automation systems CPX-AP-I</p>	 <p>For automation systems CPX-AP-I</p>
Protocol		EtherCAT, EtherNet/IP, IO-Link®, PROFIBUS DP-V1, PROFINET IRT, PROFINET RT
Max. address capacity, inputs		244 ... 2048 byte
Maximum address volume for outputs		244 ... 2048 byte
Degree of protection		IP65, IP67
Description	<ul style="list-style-type: none"> • Fits perfectly into our holistic product portfolio of electromechanical actuators, motors, drive controllers and control systems • High-performance remote I/O system that flexibly networks 80 modules in real time with a 200 Mbaud data rate • End-to-end connectivity with extended diagnostics option increases machine availability and productivity • Easy to integrate into the controller of your choice: PROFINET, EtherCAT, EtherNet/IP, ModbusTCP • Real-time capability and deterministic system behavior enable a cycle time of up to 250 µs • Cable lengths of up to 50 m between each module enable giant system dimensions • IO-Link master and configuration software enable any IO-Link devices to be integrated simply • Ethernet performance up to valve manifold and digital or analog I/O modules • Sustainable in operation due to energy shutdown 	<ul style="list-style-type: none"> • Fits perfectly into our holistic product portfolio of electromechanical actuators, motors, drive controllers and control systems • Decentralized and lightweight I/O system in IP65/IP67 • Highly flexible remote IO system with maximum performance • Can be expanded and easily combined with CPX-AP-I and CPX-AP-A to form an integrated system • End-to-end connectivity with extended diagnostics option increases machine availability and productivity • Easy to integrate into the controller of your choice: PROFINET, EtherCAT, EtherNet/IP, ModbusTCP • Module for IO-Link® available • High-performance remote I/O system that flexibly networks 80 modules in real time with a 200 Mbaud data rate • Cable lengths of up to 50 m between each module enable giant system dimensions
online: →	cpx-api	cpx-api

Electrical peripherals

	 Automation systems CPX-E	 Electrical interface CPX-CTEL	 Measuring modules CPX-CMIX
Protocol		I-Port, IO-Link®	
Electrical actuation	Fieldbus, Integrated controller		
Max. address capacity, inputs	64 byte	32 byte	
Maximum address volume for outputs	64 byte	32 byte	
Parameterization		Diagnostic behavior, Fail-safe modes per channel, Forcing per channel, Idle mode per channel, Module parameters, Tool change mode	
Degree of protection	IP20	IP65, IP67	IP65, as per IEC 60529
Nominal operating voltage DC		24 V	24 V
DC operating voltage range		18 ... 30 V	18 ... 30 V
Description	<ul style="list-style-type: none"> • Fits perfectly into our holistic product portfolio of electromechanical actuators, motors, drive controllers and control systems • Modern control system with high performance • Fieldbus master interfaces, EtherCAT® master, fieldbus slave interfaces, PROFINET, EtherNet/IP, PROFIBUS, EtherCAT digital input modules (16DI), digital output modules (8DO/0.5A) • Analog input modules (current, voltage), analog output modules (current, voltage) • Modern programming with CoDeSys V3 to IEC 61131-3 • Integration of SoftMotion functions (SoftMotion) • Compact I/O assembly • Easy mounting of the control system 	<ul style="list-style-type: none"> • CPX-CTEL master module with 4 I-Port connections • Decentralized pneumatic components and sensors for fast processes • Standardized M12 connections 	<ul style="list-style-type: none"> • Pneumatics and electrics – movement and measurement on one platform • Innovative measurement technology for piston rod actuators, rodless actuators, rotary actuators • Control via fieldbus • Remote maintenance, remote diagnostics, web server, SMS and e-mail alerts are all possible via TCP/IP • Modules can be quickly exchanged and expanded without altering the wiring
online: →	cpx-e	cpx-ctel	cpx-cmix

Product overview

Electrical peripherals

	 <p>Fieldbus modules CTEU</p>	 <p>AS-Interface® module ASI</p>
Protocol	AS-Interface, CANopen, CC-LINK®, DeviceNet, EtherCAT, EtherNet/IP, PROFINET, PROFIBUS DP, PROFINET RT, VARAN, Modbus® TCP, PROFIBUS DP	
Electrical actuation		
Max. address capacity, inputs	2 ... 64 byte	
Maximum address volume for outputs	2 ... 64 byte	
Parameterization	Activate diagnostics, Diagnostic behavior, Fail-safe and idle response, Fail-safe response, IO-Link mode, Watchdog disable, Watchdog enable	
Degree of protection	IP65, IP67	
Nominal operating voltage DC	24 ... 30 V	
DC operating voltage range	18 ... 31.6 V	
Description	<ul style="list-style-type: none"> • For pneumatic valve manifolds VTUG, MPA-L, VTOC • Can be expanded into the installation system CTEL • Fieldbus-typical LEDs, interfaces, and switching elements • Isolated power supply for electronics and pneumatic valves 	<ul style="list-style-type: none"> • Accessories for the AS-Interface® installation system • Compact I/O modules (IP65, IP67)
online: →	cteu	as-interface

Customized components – for your specific requirements



Valve manifolds with customized designs

Can't find the valve manifold you need in our catalog?

We can offer you customized components that are tailored to your specific requirements.

Common product modifications:

- Coatings for special ambient conditions
- Customized cables: length, pin allocation, pre-assembled with plug
- Modified actuating elements
- Modified connecting thread
- Modified valve sub-bases

Many additional variants are possible.

Ask your Festo sales engineer, who will be happy to help:

→ www.festo.com/contact



Product overview

Software tools

Connectivity Finder



This tool can be used to find the optimum way to connect a Festo solution to your preferred (non-Festo) controller. In addition, you will be provided with expert knowledge for your selected connection option, making the integration of the Festo solution into your machine extremely easy.

This tool can be found at
→ www.festo.com/x/connectivity-finder

Configurator

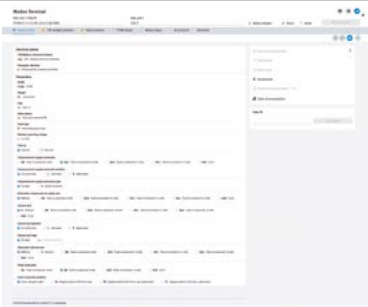

Design a product with numerous characteristics reliably and quickly with the help of the configurator.

Select all the required product characteristics step-by-step. The use of logic checks ensures that only correct configurations are available for selection.

You will find the configurator

- at www.festo.com/catalogue/vtem
- Click the product
- Click the blue „Configure product“ button

Motion Terminal



Motion Terminal
VTEM

Valve manifold design	Fixed grid
Width dimension	28 mm
Max. no. of valve positions	8
Valve function	Can be assigned using Motion App
Standard nominal flow rate exhaust air 6->5 bar	480 l/min
Pneumatic connection 1	G3/8
Operating pressure [MPa]	0.3 ... 0.8 MPa
Operating pressure	3 ... 8 bar
Operating pressure [psi]	43.5 ... 116 psi
Information on operating pressure	0 - 8 bar with external pilot air, Vacuum operation at connection 3 only
Pilot pressure [MPa]	0.3 ... 0.8 MPa
Pilot pressure	3 ... 8 bar
Pilot pressure [psi]	43.5 ... 116 psi
Motion Apps	Leakage diagnostics, Flow control, ECO drive, Positioning, Proportional pressure regulation, Proportional directional control valve, Soft Stop, Presetting of travel time, Directional control valve functions, Supply and exhaust air flow control, Model-based proportional pressure regulation, Selectable pressure level
Actuation type	Electrical
Nominal operating voltage DC	24 V
Temperature of medium	5 ... 50°C
LABS conformity	VDMA24364 zone III
Description	<ul style="list-style-type: none"> • Many functions for movement, pressure and flow in one component – thanks to apps • Maximum repeat accuracy through digital parameter sets • Simple traceability – ideal for Industry 4.0 • Simple duplicability of the parameters • Increased industrial energy efficiency • Reduced complexity and time to market • Increasing profitability and know-how protection • Predictive maintenance • Low installation costs • Sustainable operation due to pressure-reduced return stroke and leakage detection
online: →	vtem

Product overview

Motion apps

Motion Apps



Motion apps
GAMM

Description	<ul style="list-style-type: none"> • Open and closed loop control programs for pneumatic valves VEVN • A new dimension in flexibility thanks to Motion Apps – a single pneumatic valve with nine different functions • Accelerated engineering processes • Short response times without the need to adapt the hardware • Reduced system complexity • Shorter time to market for your application
online: →	gamm

Accessories for Motion Terminal >

Piezo valves



Valves
VEVM

Valve function	Can be assigned using Motion App
Standard flow rate 0.8->0 MPa (8->0 bar, 116->0 psi)	1000
Operating pressure [MPa]	0.3 ... 0.8 MPa
Operating pressure	3 ... 8 bar
Pneumatic connection 1	G3/8
Nominal width	4.2 mm
Nominal operating voltage DC	24 V
Description	<ul style="list-style-type: none"> • Functionality assignable via Motion app • For Motion Terminal VTEM • Consisting of 4 wired piezo pilot-controlled piston seat valves • Extremely long service life • Very low power consumption • Low leakage with the function of a proportional pressure regulator
online: →	vevm

Accessories for Motion Terminal >

Position sensors



Position transmitters
SDAP-MHS

Design	for T-slot
Sensing range	0 ... 160000 µm
Analog output	4 - 20 mA
Electrical connection, connection type	Cable with plug
Electrical connection, connection technology	M8x1 A-coded as per EN 61076-2-104
Electrical connection 3, occupied pins/wires	4
Description	<ul style="list-style-type: none"> • Only for use with Festo Motion Terminal VTEM • Analog sensor for VTEM input module CTMM • Measuring principle: magnetic Hall • Can be inserted into the slot from above, secured with screw • LED status indications • Cable length 0.3 m • Suitable for T-slot
online: →	sdap

Accessories for Motion Terminal >

Input modules



Input modules
CTMM

Electrical connection input, function	Analog input, Digital input
Electrical connection input, connection type	8x socket
Electrical connection input, connection technology	M8x1, A-coded as per EN 61076-2-104
Electrical connection, input, number of pins/wires	3, 4
No. of inputs	8
Nominal operating voltage DC	24 V
Signal range	4 - 20 mA
Diagnostics via LED	Faults per module, Status per channel
Degree of protection	IP65, IP67
Description	<ul style="list-style-type: none"> • For connecting analog and digital sensors to the Motion Terminal • Digital module with PNP logic or analog module for 4 ... 20 mA • Input signals can be transmitted to a higher-level controller by the Motion Apps
online: →	ctmm

Product overview



Product overview

Software tools

Festo Design Tool 3D



The Festo Design Tool 3D is a 3D product configurator for generating specific CAD product combinations from Festo.





The configurator makes your search for the right accessory quicker, easier, and more reliable

You can then order the module that has been created as a single order item – either completely pre-assembled or as individual parts in a single box. This considerably reduces your bill of materials, and downstream processes such as product ordering, order picking and assembly are significantly simplified.

This tool can be found at
[→ www.festo.com/fdt-3D](http://www.festo.com/fdt-3D)





Proximity switches >

Proximity switches for T-slot

	 Proximity sensors SMT-8M-A	 Proximity sensors SDBT-MSX	 Proximity sensors SDBT-BSW	 Proximity sensors SDBT-MS-EX6
Electrical connection, connection type	Cable, Cable with plug	Cable, Cable with plug	Cable, Cable with plug	Cable
Electrical connection, connection technology	M12x1 A-coded as per EN 61076-2-101, M8x1 A-coded as per EN 61076-2-104, Open end	M12x1 A-coded as per EN 61076-2-101, M8x1 A-coded as per EN 61076-2-104, Open end	M12x1 A-coded as per EN 61076-2-101, Open end	Open end
DC operating voltage range	5 ... 30 V	10 ... 30 V	10 ... 30 V	7.5 ... 18 V
Switching element function	N/C contact, N/O contact	N/C contact/N/O contact switchable	N/O contact	NAMUR
Switching output	NPN, PNP, Non-contact, 2-wire	PNP/NPN switchable	NPN, PNP, Non-contact, 2-wire	NAMUR
Description	<ul style="list-style-type: none"> Measuring principle: magneto-resistive Universal applications Individually configurable or pre-assembled Can be inserted into the slot from above, flush with the cylinder profile LED switching status indication LED operating reserve indication Cable length 0.1 ... 30 m 	<ul style="list-style-type: none"> Measuring principle: magnetic Hall Auto teach-in: automatic teach-in of the switching point at system start-up Programmable: PNP/NPN, NO/NC and switching window width between 2 ... 15 mm Can be inserted into the slot from above, secured with screw LED status indications Cable length 0.3 ... 5 m 	<ul style="list-style-type: none"> Measuring principle: magneto-resistive Welding field resistant Resistant to welding spatter For contactless piston-rod position sensing on Festo pneumatic cylinders, in particular the hinge cylinder DW/DWA/DWB/DWC for AMI Can be inserted into the slot from above, secured with screw LED switching status indication Cable length 0.3 ... 5 m 	<ul style="list-style-type: none"> Measuring principle: magneto-resistive As per EU explosion protection directive (ATEX) Can be inserted into the slot from above, secured with screw LED switching status indication Cable length 2.5 ... 20 m
online: →	smt-8m	sdbt	sdbt	sdbt

Proximity switches >





Proximity switches for T-slot

	 Proximity sensors SMT-8-SL	 Proximity sensors SMT-8G	 Proximity sensors CRSMT-8M	 Proximity switch SME-8
Electrical connection, connection type	Plug	Cable, Cable with plug	Cable, Cable with plug	Cable
Electrical connection, connection technology	M8x1 A-coded as per EN 61076-2-104	M8x1 A-coded as per EN 61076-2-104, Open end	M12x1 A-coded as per EN 61076-2-101, M8x1 A-coded as per EN 61076-2-104, Open end	Open end
DC operating voltage range	10 ... 30 V	10 ... 30 V	5 ... 30 V	0 ... 230 V
Switching element function	N/O contact	N/O contact	N/O contact	N/O contact
Switching output	PNP	NPN, PNP	PNP	Contact-based, bipolar
Description	<ul style="list-style-type: none"> • Measuring principle: magneto-resistive • SMT-8-SL: sturdy thanks to long guides and plug directly at the sensor • Can be inserted into the slot lengthwise or from above • LED switching status indication • Cable length 0.3, 2.5, 5 m 	<ul style="list-style-type: none"> • Measuring principle: magneto-resistive • SMT-8G: design ideal for gripper sensing • Can be inserted into the slot lengthwise or from above • LED switching status indication • Cable length 0.3, 2.5, 5 m 	<ul style="list-style-type: none"> • Measuring principle: magneto-resistive • Corrosion-resistant design • Food-safe (see www.festo.com/certificates/CRSMT_8M), resistant to acids and cooling lubricants • Can be inserted into the slot from above, flush with the cylinder profile • LED switching status indication • Cable length 0.3 m, 5 m, 10 m 	<ul style="list-style-type: none"> • Measuring principle: magnetic reed • Can be inserted into the slot lengthwise • LED switching status indication • Cable length 0.3, 2.5, 5, 7.5, 0.2 ... 10 m
online: →	smt-8	smt-8G	crsmt-8m	sme-8

Product overview



Proximity switches >

Proximity switches for T-slot

	 Proximity switch SME-8M	 Proximity sensors SMT0-8E	 Proximity sensors SMPO-8E	 Proximity sensors SMTSO-8E
Electrical connection, connection type	Cable, Cable with plug	Plug		Plug
Electrical connection, connection technology	M8x1 A-coded as per EN 61076-2-104, Open end	M12x1 A-coded as per EN 61076-2-101, M8x1 A-coded as per EN 61076-2-104		M12x1 A-coded as per EN 61076-2-101
DC operating voltage range	5 ... 30 V	10 ... 30 V		10 ... 30 V
Switching element function	N/O contact	N/O contact		N/O contact
Switching output	Contact-based, bipolar	NPN, PNP		NPN, PNP
Description	<ul style="list-style-type: none"> Measuring principle: magnetic reed Individually configurable or pre-assembled Can be inserted into the slot from above, flush with the cylinder profile LED switching status indication Cable length 0.3, 2.5, 5, 7.5, 0.2 ... 10 m 	<ul style="list-style-type: none"> Measuring principle: magneto-resistive Sturdy sensor in block design Plug integrated in housing LED switching status indication Insertable in slot from above 	<ul style="list-style-type: none"> Measuring principle: magnetic Pneumatic proximity sensor Function: 3/2-way valve, normally closed Pneumatic connection via internal thread M5 Visual switching status indication 	<ul style="list-style-type: none"> Measuring principle: magneto-inductive Welding field immune design Sturdy sensor in block design Insertable in slot from above Plug integrated in housing LED switching status indication
online: →	sme-8m	smt0	smpo	smtso

Proximity switches >



Round slot proximity sensor

	 Proximity switch SMT-10M	 Proximity switch SMT-10G	 Proximity switch SME-10M
Electrical connection, connection type	Cable, Cable with plug	Cable, Cable with plug	Cable, Cable with plug
Electrical connection, connection technology	M12x1 A-coded as per EN 61076-2-101, M8x1 A-coded as per EN 61076-2-104, Open end	M8x1 A-coded as per EN 61076-2-104, Open end	M8x1 A-coded as per EN 61076-2-104, Open end
Electrical connection, number of pins/wires	2, 3	3	3
DC operating voltage range	5 ... 30 V	10 ... 30 V	5 ... 30 V
Switching element function	N/O contact	N/O contact	N/O contact
Switching output	NPN, PNP, Non-contact, 2-wire	NPN, PNP	Contact-based, bipolar
Description	<ul style="list-style-type: none"> • Measuring principle: magneto-resistive • Universal applications • Individually configurable or pre-assembled • Can be inserted into the slot from above, flush with the cylinder profile • LED switching status indication • Cable length 0.3, 2.5 m 	<ul style="list-style-type: none"> • Measuring principle: magneto-resistive • SMT-10G: design ideal for gripper sensing • Can be inserted into the slot lengthwise or from above • LED switching status indication • Cable length 0.3, 2.5 m 	<ul style="list-style-type: none"> • Measuring principle: magnetic reed • Individually configurable or pre-assembled • Can be inserted into the slot from above, flush with the cylinder profile • LED switching status indication • Cable length 0.3, 2.5 m
online: →	smt-10M	smt-10	sme-10m

Product overview

Proximity switches >

Proximity switches with block design

	 <p>Proximity sensors SMT-C1</p>	 <p>Proximity switch SDBF</p>
Electrical connection, connection type	Cable, Cable with plug	Cable, Cable with socket
Electrical connection, connection technology	M12x1 A-coded as per EN 61076-2-101, M8x1 A-coded as per EN 61076-2-104, Open end	M12x1 A-coded as per EN 61076-2-101, M8x1 A-coded as per EN 61076-2-104, Open end
Electrical connection, number of pins/wires	3	3
DC operating voltage range	10 ... 30 V	5 ... 28 V
Switching element function	N/O contact	N/O contact
Switching output	PNP	NPN, PNP
Description	<ul style="list-style-type: none"> • Measuring principle: magneto-inductive • Easy-to-clean design • Food grade see www.festo.com/certificates/SMT_C1 • For Clean Design ISO cylinder DSBF with mounting rail for sensors • LED switching status indication 	<ul style="list-style-type: none"> • Measuring principle: magneto-resistive • LED switching status indication
online: →	smt-c1	sdbf





Proximity switches >

Cylinder signal transducers

	 <p>Cylinder signal transducers PPL</p>
Description	<ul style="list-style-type: none"> • For contactless pneumatic signal generation at the end of cylinder strokes • Function: 3/2-way valve, normally open • Can be screwed directly into the supply port of the cylinder using a hollow bolt
online: →	ppl



Inductive proximity sensors

Inductive sensors

	 Proximity switch SIEN	 Proximity switch SIED	 Proximity switch SIEF	 Proximity switch SIEH
Size	4 mm, 6.5 mm, M12, M12x1, M18, M18x1, M30, M30x1.5, M5x0.5, M8x1	M12, M18, M30	40x40x65 mm, M12, M18, M30, M8	3 mm, M12, M18
Switching output	NPN, PNP	Non-contact, 2-wire	NPN, PNP	NPN, PNP
Switching element function	N/C contact, N/O contact	N/O contact	Antivalent, N/O contact	N/C contact, N/O contact
Electrical connection	3-wire, Cable	2-wire, 2-pin, Cable, Plug, M12x1	3-wire, 3-pin, 4-pin, Fixcon, Cable, Plug, M8x1, M12x1	
DC operating voltage range	10 ... 30 V	10 ... 320 V	10 ... 65 V	10 ... 30 V
Description	<ul style="list-style-type: none"> • With standard switching distance • For DC voltage • Round design • Metric thread • Flush or non-flush mounting • LED switching status indication • Design with metal or polyamide housing 	<ul style="list-style-type: none"> • With standard switching distance • For DC and AC voltage • Metric thread • Flush or non-flush mounting • LED switching status indication • Design with metal or polyamide housing 	<ul style="list-style-type: none"> • Reduction factor 1 for all metals • Welding field resistant • Design with housing resistant to welding spatter • Flush, partially flush, or non-flush mounting • LED switching status indication 	<ul style="list-style-type: none"> • With increased switching distance • Flush installation • Metric thread • LED switching status indication • Design with stainless steel housing
online: →	sien	sied	sief	sieh

Inductive proximity sensors



Inductive sensors

	 Proximity switch SIES-Q	 Proximity switch SIES-8M	 Distance sensor SOIA
Size	8x8x59 mm, 15x20x30 mm, 40x40x120 mm, 5x5x25 mm, 8x8x40 mm	Slot 8	M8, M12, M18, M30, Q40
Switching output	NPN, PNP	NPN, PNP	PNP/NPN switchable, Push-pull
Switching element function	Antivalent, N/C contact, N/O contact	N/C contact, N/O contact	Switchable
Electrical connection	Screw terminal		
DC operating voltage range	10 ... 30 V	10 ... 30 V	10 ... 30 V
Description	<ul style="list-style-type: none"> • Block design • Flush installation • LED switching status indication 	<ul style="list-style-type: none"> • Suitable for position sensing for electric axes and grippers with T-slot • Flush installation • Switching status indication with 2 LEDs for better visibility regardless of the direction from which it is approached • Single inductive proximity sensor for 8 slot with patented LED status indication 	<ul style="list-style-type: none"> • Inductive distance, speed and acceleration sensor • Sensor for monitoring pneumatic, hydraulic and elastic cushioning • IO-Link® 1.1 Smart Sensor Profile • Sizes: M8, M12, M18, M30, Q40 • Enables predictive maintenance and prevents expensive production downtime
online: →	sies	sies	soia

Product overview



Position sensors >

Position transmitter

	 Position transmitter SDAC-MHS	 Position transmitters SDAT-MHS	 Position transmitters SDAS-MHS
Design	for round slot	for T-slot	for T-slot
Sensing range	25000 ... 35000 µm	0 ... 160000 µm	≤52000 µm
Analog output	0 - 10 V	0 - 10 V, 4 - 20 mA	
Electrical connection, connection type	Cable, Cable with plug	Cable with plug	Cable, Cable with plug
Electrical connection, connection technology	M8x1 A-coded as per EN 61076-2-104, Open end	M8x1 A-coded as per EN 61076-2-104	M8x1 A-coded as per EN 61076-2-104, Open end
Electrical connection 3, occupied pins/wires	3, 4	4	4
Description	<ul style="list-style-type: none"> Measuring principle: magnetic Hall Sensing range up to 35 mm IO-Link, 2 programmable switching outputs Analog output 0 ... 10 V Very compact design makes the unit especially well suited to work with pneumatic grippers, compact air cylinders and any application that needs to be performed in a tight space LED status indications Cable length 0.3, 2.5 m Suitable for round groove 	<ul style="list-style-type: none"> Measuring principle: magnetic Hall Analog output 0 ... 10 V or 4 ... 20 mA Programmable IO-Link®/switching output Can be inserted into the slot from above, secured with screw LED status indications Cable length 0.3 m Suitable for T-slot 	<ul style="list-style-type: none"> Measuring principle: magnetic Hall IO-Link, 2 programmable switching outputs Insertable in slot from above Very compact design makes the unit especially well suited to work with pneumatic grippers, compact air cylinders and any application that needs to be performed in a tight space LED status indications Cable length 0.3, 2.5 m Suitable for T-slot
online: →	sdac	sdat	sdas

Position sensors >

Position transmitter

	 Position transmitter SMAT-8M	 Position transmitters SDAP-MHS
Design	for T-slot	for T-slot
Sensing range	≤52000 µm	0 ... 160000 µm
Analog output	0 - 10 V, 0 - 10 V	4 - 20 mA
Electrical connection, connection type	Cable, Cable with plug	Cable with plug
Electrical connection, connection technology	M8x1 A-coded as per EN 61076-2-104, Open end	M8x1 A-coded as per EN 61076-2-104
Electrical connection 3, occupied pins/wires	3, 4	4
Description	<ul style="list-style-type: none"> Measuring principle: magnetic Hall Analog output 0 ... 10 V Very compact design makes the unit especially well suited to work with pneumatic grippers, compact air cylinders and any application that needs to be performed in a tight space Can be inserted into the slot from above, secured with screw LED status indications Cable length 0.3 m Suitable for T-slot 	<ul style="list-style-type: none"> Only for use with Festo Motion Terminal VTEM Analog sensor for VTEM input module CTMM Measuring principle: magnetic Hall Can be inserted into the slot from above, secured with screw LED status indications Cable length 0.3 m Suitable for T-slot
online: →	smat-8m	sdap



Position sensors >

Position sensors for rotary drives

	 <p>Position sensors SRBS</p>
Design	Round
Sensing range	270 deg
Max. output current	50
Electrical connection 1, connection type	Cable with plug
Electrical connection, connection technology	M8x1 A-coded as per EN 61076-2-104
Electrical connection 1, number of pins/wires	4
Description	<ul style="list-style-type: none"> • Used to detect rotation of the shaft on rotary actuators DRVS and DSM • Simple and reliable operation using just one pushbutton directly on the device • Switching output 2x PNP or 2x NPN, switchable • The sensor can be quickly assembled without having to manually search for switching points
online: →	srbs

Position sensors >





Linear measuring systems

	 <p>Linear measuring systems MME-MTS-TLF</p>	 <p>Displacement encoders MLO-POT-TLF</p>	 <p>Displacement encoders MLO-POT-LWG</p>
Stroke	225 ... 2000 mm	225 ... 2000 mm	100 ... 750 mm
Measuring principle of linear potentiometer	Digital	Analog	Analog
Output signal	CAN protocol type SPC-AIF	Analog	Analog
Displacement resolution	<0.01 mm	0.01 mm	0.01 mm
Electrical connection	6-pin, Plug, as per DIN 45322, Round design	4-pin, Form A, Plug, as per DIN 43650, Rectangular design	4-pin, Plug, Rectangular design, 16 mm
Description	<ul style="list-style-type: none"> • Measuring principle: magnetostrictive • Contactless with absolute measurement • High travel speed • System product for servopneumatic positioning technology and Soft Stop • IP65 Rating 	<ul style="list-style-type: none"> • Conductive plastic potentiometer • Absolute measurement with high resolution • High travel speed and long service life • Plug-in connections 	<ul style="list-style-type: none"> • Connecting rod potentiometer • Absolute measurement with high resolution • Long service life • IP65 Rating • Plug-in connections
online: →	mme	mlo	mlo

Product overview





Vacuum pressure switches

Pressure and vacuum sensors

	 Pressure sensors SPAF	 Pressure sensors SPAE	 Pressure sensors SDE5	 Pressure sensors SPAN, SPAN-B
Pressure measuring range [MPa]	-0.1 ... 1 MPa	-0.1 ... 1 MPa		-0.1 ... 1.6 MPa
Pressure measuring range	-1 ... 10 bar	-1 ... 10 bar	-1 ... 10 bar	-1 ... 16 bar
Pressure measuring range [psi]	-14.5 ... 145 psi	-14.5 ... 145 psi		-14.5 ... 232 psi
Switching element function	N/C contact/N/O contact switchable	N/C contact, N/O contact, Switchable	N/C contact, N/O contact, Switchable	N/C contact/N/O contact switchable
Switching output	PNP/NPN switchable	PNP/NPN switchable	NPN, PNP	2 x PNP or 2 x NPN switchable, PNP/NPN switchable
Pneumatic connection	External thread G1/8, QS-4, QS-6	Flange, Cartridge 10, Push-in sleeve QS-4, QS-6, QS-3, QS-4	QS-1/4, QS-4, QS-5/32, QS-6	external thread 1/8 NPT, Female thread G1/8, M5, For tubing O.D. 4, Male thread G1/8, R1/8
Electrical connection		3-wire, Cable, Open end	3-wire, 3-pin, Cable, Plug, as per EN 60947-5-2, Round design, M8x1	
Electrical connection 1, connection type	Plug			Plug
Display type	Illuminated LCD blue, LED display	LED display, 2-digit		Illuminated LCD
Description	<ul style="list-style-type: none"> • IO-Link® communication interface • IP65 Rating • Designs with display or LED switching status indication • Replication function for quick transfer of settings • Switching output (PNP / NPN; NO / NC) adjustable via software • One key teach-in switching point setting 	<ul style="list-style-type: none"> • Electronic pressure sensor with piezoresistive pressure measuring cell, integrated signal processing, numeric pressure gauge in percent, operating key and a switching output, PNP/NPN switchable • Display of minimum and maximum readings • All parameters entered can be transferred to other SPAEs (replicator function) • Communication interface IO-Link® 	<ul style="list-style-type: none"> • Programmable and configurable pressure switch for simple pressure sensing tasks • Threshold/window comparator • Switching point adjustment by teach-in function • Integrated microprocessor • Switching status indicated by an LED visible from all sides • Certification: c UL us Listed (OL), C-Tick 	<ul style="list-style-type: none"> • For monitoring compressed air and non-corrosive gases • For network monitoring, regulator monitoring, leak test, object detection • Relative method of measurement based on a piezoresistive measuring cell • Serial communication integrated using IO-Link® 1.1 • Compact design 30 x 30 mm • High-contrast display with blue backlight
online: →	spaf	spae	sde5	span

Vacuum pressure switches

Pressure and vacuum sensors

	 Pressure sensors SPAU	 Pressure sensors SPAW	 Pressure sensors SDE3	 Pressure switches SPBA
Pressure measuring range [MPa]	-0.1 ... 1.6 MPa	-0.1 ... 10 MPa	-0.1 ... 1 MPa	
Pressure measuring range [bar]	-1 ... 16 bar	-1 ... 100 bar	-1 ... 10 bar	
Pressure measuring range [psi]	-14.5 ... 232 psi	-14.5 ... 1450 psi	-14.5 ... 145 psi	
Switching element function	N/C contact/N/O contact switchable	Switchable	Switchable	Antivalent, Changeover switch
Switching output	2 x PNP or 2 x NPN switchable, 2xPNP	2xNPN, 2xPNP	2xNPN, 2xPNP	2xPNP, Contact-based
Pneumatic connection	Flange, G1/8, 1/8 NPT, QS-6, G1/8, M5, M7, QS-4, QS-5/32, QS-6, R1/4, R1/8	Female thread G1/4, Male thread G1/2	QS-4, QS-5/32	G1/8
Electrical connection				4-pin, Plug, as per EN 60947-5-2, Round design, M12x1
Electrical connection 1, connection type	Plug	Plug	Cable, Cable with plug, Plug	Plug
Display type	Illuminated LCD, LED	4-character alphanumeric, LED display	Illuminated LCD	
Description	<ul style="list-style-type: none"> • For monitoring compressed air and non-corrosive gases • With or without display • Transfer of the pressure value as switch signal, analog signal, or via IO-Link® to the connected control system • Maximum versatility thanks to a wide range of pneumatic adaptations and switchable electrical outputs 	<ul style="list-style-type: none"> • Highly robust • For liquid and gaseous media • Quick and easy adjustment of the switching outputs using three pushbuttons • Optimal legibility: display housing rotatable 320°, display at an angle of 45° 	<ul style="list-style-type: none"> • Five pressure measuring ranges • Measurement of relative or differential pressure or two independent pressure inputs • Switching output 2x PNP or 2x NPN • Numerical and graphical pressure gauge • Mounting: via H-rail, via wall/surface bracket, front panel mounting, with through-holes • Certification: C-Tick, ATEX, c UL us Listed (OL) 	<ul style="list-style-type: none"> • Pressure sensor with permanently set switching point • For solenoid valve VSVA • Mounting: screw-in
online: →	spau	spaw	sde3	spba



Product overview

Vacuum pressure switches

Pressure and vacuum sensors



	 Pressure switches, vacuum switches PEV, VPEV	 Pressure transmitters SPTE	 Pressure transmitters SPTW	 Pressure switches PEN, PE, VPE
Pressure measuring range [MPa]		-0.1 ... 1 MPa	-0.1 ... 10 MPa	
Pressure measuring range		-1 ... 10 bar	-1 ... 100 bar	
Pressure measuring range [psi]		-14.5 ... 145 psi	-14.5 ... 1450 psi	
Switching element function	Changeover switch			N/O contact, Changeover switch
Switching output				PNP, Contact-based
Pneumatic connection	G1/4, G1/8, M5	Flange, Cartridge 10, Push-in sleeve QS-4, QS-6, QS-3, QS-4	G1/4	G1/8, M5, PK-4
Electrical connection	4-pin, Form A, Plug, as per DIN 43650, as per EN 60947-5-2, Round design, Rectangular design, M12x1	3-wire, Cable, Open end		3 connecting wires, 3-wire, 4-wire, Cable, Open end
Electrical connection 1, connection type	Screw terminal, Plug		Plug	Cable
Display type				
Description	<ul style="list-style-type: none"> • Mechanical pressure and vacuum switch • Adjustable switching point • Mounting: screw-in, via through-holes or via H-rail • Visual scale for pressure adjustment • Certification: CCC, c UL us – Recognized (OL), RCM Mark 	<ul style="list-style-type: none"> • Piezoresistive pressure sensor • Measured variable: relative pressure • Cable length 2.5 m • Compact: 8-bracket wall mount for manifold assembly 	<ul style="list-style-type: none"> • Sensor versions: piezoresistive pressure sensor or metal thin-film pressure sensor • Measured variable: relative pressure • Operating medium: liquid media and gaseous media • Seal-free: pressure measuring cell and interfaces in stainless steel • Protection: IP67 	<ul style="list-style-type: none"> • Pneumatic/electric differential pressure switch • Pneumatic/electric pressure transducer • Design for vacuum • Mounting via through-holes, on mounting frame 1n, on mounting frame 2n • Splash-proof design • Certification: CCC, RCM Mark
online: →	pev	spte	sptw	pen

Flow sensors

	 Flow transmitter SFTE	 Air flow sensors SFAH	 Air flow sensors SFAW
Flow measuring range	0 ... 10 l/min	0.002 ... 200 l/min	1.8 ... 100 l/min
Operating medium	Nitrogen, Compressed air ISO 8573-1:2010 [6:4:4]	Argon, Nitrogen, Compressed air ISO 8573-1:2010 [6:4:4]	Liquid media, Water, Neutral liquids
Operating pressure	-0.9 ... 10 bar	-0.9 ... 10 bar	0 ... 12 bar
Pneumatic connection	Female thread M5, For push-in connector O.D. 3, 4	Female thread G1/4, G1/8, For tubing O.D. 4, 6, 8	
Switching output		2 x PNP or 2 x NPN switchable	2 x PNP or 2 x NPN switchable
Electrical connection, connection type	Cable, Cable with plug	Plug	Plug
Electrical connection, connection technology	M8x1 A-coded as per EN 61076-2-104, Open end	Connection diagram L1J, M8x1 A-coded as per EN 61076-2-104	M12x1 A-coded as per EN 61076-2-101
Electrical connection			
Description	<ul style="list-style-type: none"> • Compact design • Universal flow detection • Simple installation • Reliable pick & place application for extremely small workpieces 	<ul style="list-style-type: none"> • Process, compressed air, forming gas and pneumatic object monitoring, parts handling of ultra-small parts, leak test • Compact design 20x58 mm • Clear 2-line display • Mounting: H-rail mounting, wall or surface mounting, front panel mounting • Serial communication integrated using IO-Link® 1.1 	<ul style="list-style-type: none"> • Cooling circuit monitoring, leakage, or line break monitoring, process water monitoring, fill level monitoring • Input connection: clamped terminal connection DN15, DN20, barbed hose fitting 13 mm, internal thread G1/2, G3/4, G1, user-specific connection • With optional integrated temperature sensor • Connection to higher-level systems is provided by two switching outputs, an analog output and/or an IO-Link® interface • Certification: RCM, c UL us Listed (OL) • Rotatable display, 90° anticlockwise and 180° clockwise
online: →	sfte	sfah	sfaw





Product overview

Flow sensors

	 Flow sensors SFAB	 Flow sensors SFAM
Flow measuring range	0.1 ... 1000 l/min	10 ... 15000 l/min
Operating medium	Argon, Carbon dioxide, Nitrogen, Compressed air ISO 8573-1:2010 [7:4:4], ISO 8573-1:2010 [6:4:4]	Argon, Compressed air as per ISO 8573-1:2010 [7:4:4], Carbon dioxide, Nitrogen, Compressed air ISO 8573-1:2010 [7:4:4]
Operating pressure	0 ... 10 bar	16 bar
Pneumatic connection	For tubing O.D. 1/4, 10, 12, 3/8, 5/16, 6, 8	Battery module, 1/2 NPT, 1 NPT, 1 1/2 NPT, G1, G1 1/2, G1/2
Switching output	2 x PNP or 2 x NPN switchable	2 x PNP or 2 x NPN switchable
Electrical connection, connection type	Plug	Plug
Electrical connection, connection technology	M12x1 A-coded as per EN 61076-2-101	M12x1 A-coded as per EN 61076-2-101
Electrical connection		5-pin, Plug, straight, M12x1
Description	<ul style="list-style-type: none"> • Air flow sensor with integrated digital display • With unidirectional flow input • Mounting: H-rail mounting, wall or surface mounting • Certification: C-Tick • Sustainable operation through monitoring of system consumption 	<ul style="list-style-type: none"> • IO-Link® communication with efficient remote parameterization and replication function • All-in-one solution with integrated pressure and temperature measurement • As a stand-alone device or as a space-saving version in the service unit components of the MS series • Supplies absolute flow information and accumulated air consumption measurements • High accuracy, even at compressed air quality [7:4:4] to ISO 8573 • Reliable measurement even of high flow rates • Sustainable operation through monitoring of system consumption
online: →	sfab	sfam

Optical sensors





Opto-electrical sensors

	 Retro-reflective sensors, diffuse sensors, light barriers SOOD	 Retro-reflective sensors, diffuse sensors, distance sensor, light barriers SOOE	 Diffuse scans, retro-reflective sensors SOEG-RT, SOEG-RS	 Through-beam sensors SOEG-E, SOEG-S
Method of measurement	Reflection light barrier, Through-beam sensor, Transmitter, Receiver, Reflection light sensor with HGA	Reflection light barrier, Distance sensor, Through-beam sensor, Transmitter, Receiver, Reflection light sensor with HGA, Laser contrast sensor, Reflection light barrier for transparent objects, Reflection light sensor	Reflection light barrier, Reflection light sensor, Diffuse sensor with background suppression	Through-beam sensor, Receiver, Transmitter
Working range	0 ... 10000 mm	0 ... 20000 mm	10 ... 2000 mm	20000 mm
Size			M12, M12x1, M18, M18x1	M18x1
Setting options		IO-Link®, Potentiometer, Teach-in	Potentiometer	
Type of light	Laser, Red, LED	Laser, Red, LED	Red, Red polarized	Red
Switching output	Push-pull	Push-pull	NPN, PNP	NPN, PNP
Description	<ul style="list-style-type: none"> • Simple operation • Fast commissioning • Reliable and stable detection • Attractive price/performance ratio 	<ul style="list-style-type: none"> • Simple operation • Fast commissioning • Reliable and stable detection • Attractive price/performance ratio 	<ul style="list-style-type: none"> • Round design • Electrical connection via open cable end or plug 	<ul style="list-style-type: none"> • Round design • Electrical connection via open cable end or plug
online: →	sood	sooe	soeg	soeg

Product overview

Optical sensors

Opto-electrical sensors

	 Color sensors SOEC	 Fiber optic units SOE4	 Fork light barriers SOOF	 Light guides SOEZ, SOOC
Method of measurement	Color sensor	Fiber-optic unit	Fork light barrier	Through-beam sensor, Fork light barrier, Fiber-optic cable, Reflection light sensor
Working range	12 ... 32 mm			5 ... 400 mm
Size	50x50x17 mm		Clevis 120x60 mm, 30x35 mm, 50x55 mm, 80x55 mm	M4, M6
Setting options	Teach-in, Teach-in via electrical connection	Teach-in, Teach-in via electrical connection	IO-Link®, Potentiometer, Teach-in	
Type of light	White	Red	Red	
Switching output	PNP	NPN, PNP	Push-pull, NPN, PNP	
Description	<ul style="list-style-type: none"> • Diffuse scan • Block design • Electrical connection via M12x1 plug, 8-pin • Display via 7 LEDs 	<ul style="list-style-type: none"> • Use for precise and space-saving position sensing in electronics and light assembly • Switching frequencies of up to 8000 Hz • Operational with fiber optic cable SOOC as accessory • Variants: LED or LED display, timer function • Mounting: H-rail mounting or via through-holes • With protection against mutual interference 	<ul style="list-style-type: none"> • Through-beam sensor with minimal installation effort • Design: polymer or metal • Sturdy housing: high shock and vibration resistance • Protection: IP67 • Electrical connection via M8x1 plug connector, 3-pin • LED indicators 	<ul style="list-style-type: none"> • Cable connection, push-in connector
online: →	soec	soe4	soof	soez

Signal conditioner

Signal converters

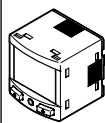



**Signal conditioner
SCDN**



Signal range	0 - 10 V, 0 - 20 mA
Switching output	2 x PNP or 2 x NPN switchable
Switching function_EN-US	Freely programmable
Electrical connection, connection type	Plug
Electrical connection, connection technology	Connection diagram L1J
Electrical connection, number of pins/wires	4
Electrical connection 2, connection type	2x socket
Electrical connection 2, connection technology	Connection diagram EC
Electrical connection 2, number of pins/wires	4
Description	<ul style="list-style-type: none"> • Converts analog signals into IO-Link® signals • Switching function freely programmable with teach-in • Mounting: wall or surface mounting, front panel mounting, manifold mounting using mounting brackets • Large, illuminated LCD display
online: →	scdn

Product overview

Limit switch attachments

	 Limit switch attachments SRBK	 End switch attachments SRBC	 End switch attachments SRBG
Information on housing materials	PA, PA66, electrically conductive	Die-cast aluminum	PBT
Operating voltage range AC	0 ... 230 V	0 ... 230 V	
DC operating voltage range	0 ... 175 V	0 ... 175 V	6 ... 60 V
Measuring principle	Inductive, Magnetic reed, Mechanical/ electrical	Inductive, Magnetic reed, Mechanical/ electrical	Inductive
Switching element function	N/O contact, Toggle switch, single-pin	N/C contact, N/O contact, Toggle switch, single-pin	N/C contact, N/C contact/N/O contact switchable, N/O contact
Safety integrity level (SIL)	SIL 3	SIL 3	SIL 2
Description	<ul style="list-style-type: none"> • Robust plastic housing with UV resistance • Different switch variants – mechanical, inductive and reed switches • Multifunctional mounting flange adapter for adaptations on the ISO3845 interface • Variants with M12 plug connection for easy installation (Plug&Play) 	<ul style="list-style-type: none"> • Pre-assembled mounting adapter for ease of installation • Trip cams can be set easily without additional tools • Sturdy, corrosion-resistant design, ideal for use in harsh operating conditions • Clearly visible 3D position indicator allows rapid detection of the current position of the quarter turn actuator • With safety functions • Variants in accordance with EU Explosion Protection Directive (ATEX) 	<ul style="list-style-type: none"> • Compact housing with M12 plug connection • Direct mounting on quarter turn actuators to VDI/VDE 3845 • For quarter turn actuators for the process automation with position indicators • AS-Interface® version with extended addressing options • LED status indicator for switching status, supply voltage and solenoid valve output • With safety functions • Variants in accordance with EU Explosion Protection Directive (ATEX)
online: →	srbk	srbc	srbg

Limit switch attachments





	 End switch attachments SRBE	 Limit switch attachments SRAP	 Limit switch box SRBI
Information on housing materials	Die cast aluminum, painted	Wrought aluminum alloy	PBT
Operating voltage range AC	0 ... 240 V		
DC operating voltage range	0 ... 60 V	15 ... 30 V	10 ... 30 V
Measuring principle	Inductive, Magnetic reed, Mechanical/ electrical, For proximity sensor	Magnetic Hall	Inductive
Switching element function	N/C contact, N/O contact, Toggle switch, single-pin, Toggle switch, double-pin		N/O contact
Safety integrity level (SIL)	SIL 3		
Description	<ul style="list-style-type: none"> • Trip cams can be set easily without additional tools • Sturdy, corrosion-resistant design, ideal for use in harsh operating conditions • Clearly visible 3D position indicator allows rapid detection of the current position of the quarter turn actuator • With safety functions • As per EU explosion protection directive (ATEX) 	<ul style="list-style-type: none"> • Based on standard VDI/VDE 3845 (NAMUR) • Analog • For monitoring the position of quarter turn actuators • Sensors based on 2D Hall technology • Variants in accordance with EU Explosion Protection Directive (ATEX) 	<ul style="list-style-type: none"> • Compact housing with M12 plug connection • Direct mounting on quarter turn actuators to VDI/VDE 3845 • For quarter turn actuators for the process automation with position indicators • LED status indicator for switching status and supply voltage
online: →	srbe	srap	srbi

Accessories for limit switch attachments

	 Position indicators SASF
Setting range of swivel angle	0 ... 360 deg
Ambient temperature	-40 - 80°C
Type of mounting	as per VDI/VDE 3845
Description	<ul style="list-style-type: none"> • For SRBG, SRBI, SRBC limit switch attachments • Variants for mounting on drive shafts of standard drives according to VDI/VDE 3845 • Variants with adjustable swivel angle • Variants for clockwise and anticlockwise rotating actuators with 90° and 180° rotation • Variants with position indicator in yellow/red, I, T, L design or with 180° arrow
online: →	sasf

Product overview



Air gap sensors

	 Air gap sensors SOPA	 Micro reflex sensors, reflex sensors RML, RFL	 Dynamic pressure transducers SD-2, SD-3, SD-3-N	 Air barriers SFL, SML
Sensing range	20 ... 200 µm			
Operating pressure	4 ... 7 bar			
Display type	Illuminated LCD, multi-color			
Operating medium	Compressed air ISO 8573-1:2010 [7:4:4]			
Description	<ul style="list-style-type: none"> • Convenient solution for high-precision contact and distance monitoring • Setting option: IO-Link® teach-in or numerical setting using three-button operation • Integrated air jet function • Multi-colored LCD display • Mounting: H-rail mounting, wall mounting, through-hole • Certification: C-Tick 	<ul style="list-style-type: none"> • Back pressure actuated valve • For contactless sensing of indicating instruments, checking pressing and stamping tools, edge control, magazine control, for measuring and counting • Can be used even in very dirty environments, in complete darkness, with translucent or magnetic objects 	<ul style="list-style-type: none"> • Can be used for stroke-dependent signal generation as a limit switch and fixed stop • Ideal for end-position sensing and position control with high accuracy requirements and small actuating forces • SD-3-N for sensing fluid levels and heavily foaming liquids • For use in inaccessible places 	<ul style="list-style-type: none"> • Sender nozzle, receiver nozzle, gap sensor • Back pressure actuated valve • Operational reliability even in very dirty environments • Reliable even at high ambient temperatures • Insensitive to mechanical influences and sound waves • Reliable even in complete darkness and when sensing translucent objects
online: →	sopa	rfl	sd	sfl



Product overview

Software tools

<p>Air consumption</p>		<p>Calculate your system's air consumption quickly and conveniently. Simply enter all the actuators and tubing, set the cycle times and working pressure and the air consumption per minute and per day will be calculated for you. It includes a feature for exporting the input table together with the result directly to Excel.</p> <p>This tool can be found at → www.festo.com/x/air-consumption</p>
<p>Configurator</p>		<p>Design a product with numerous characteristics reliably and quickly with the help of the configurator.</p> <p>Select all the required product characteristics step-by-step. The use of logic checks ensures that only correct configurations are available for selection.</p> <p>A dynamic graphic generated on the basis of the configuration provides visual assistance in selecting the correct product characteristics.</p> <p>This tool can be found at → www.festo.com/x/service-unit-sizing</p>



Maintenance units compressed air >

Series MS-B

	<p>Service units MS4-EM1FR, MS6-EM1FR</p>
<p>Size</p>	<p>4, 6</p>
<p>Pressure indicator</p>	<p>G1/8 prepared, with pressure gauge</p>
<p>Operating pressure [MPa]</p>	<p>0.1 ... 1 MPa</p>
<p>Operating pressure</p>	<p>1 ... 10 bar</p>
<p>Standard nominal flow rate</p>	<p>1500 ... 5300 l/min</p>
<p>Type of mounting</p>	<p>Optionally, Line installation, With mounting bracket, With accessories</p>
<p>Description</p>	<ul style="list-style-type: none"> • Combination of on/off valve and filter regulating valve • With condensate drain manually rotating or fully automatic • For filtered and unlubricated compressed air supply • Supply pressure can be switched on or off • Outlet pressure is continuously adjustable within the pressure regulation range
<p>online: →</p>	<p>ms4-em1fr</p>

Maintenance units compressed air >



MS series

	 Service unit combinations MSB4, MSB6, MSB9	 Air preparation combination units MSB4N, MSB6N	 Energy efficiency module MSE6
Pneumatic connection 1	G1/8, G1/4, G3/8, G1/2, G3/4, G1, 1/2 NPT, 3/4 NPT, 1 NPT, 1 1/4 NPT, 1 1/2 NPT, G1, G1 1/2, G1 1/4, G1/2, G1/4, G1/8, G3/4	1/8 NPT, 1/4 NPT, 1/2 NPT	G3/4, G1/2
Standard nominal flow rate	750 ... 18000 l/min	700 ... 5100 l/min	4500 ... 7000 l/min
Flow measuring range			50 ... 5000 l/min
Pressure regulation range	0.1 ... 16 bar	0.3 ... 12 bar	2.5 ... 10 bar
Operating pressure [MPa]	0 ... 2 MPa	0.15 ... 1.4 MPa	0.35 ... 1.3 MPa
Operating pressure	0 ... 20 bar	0.8 ... 20 bar	3.5 ... 13 bar
Grade of filtration	0.01 ... 40 µm	0.01 ... 40 µm	
Fieldbus interface			2x socket, M12x1, 4-pin, D-coded, 2x RJ45 push-pull socket, AIDA, Sub-D socket, 9-pin
Description	<ul style="list-style-type: none"> • Combination of filter regulating valve, compressed air filter, air line lubricator, shut-off valve, soft-start valve • Width dimensions 40, 62, 90 mm (size 4, 6, 9) 	<ul style="list-style-type: none"> • Combination of filter regulating valve, compressed air filter, air line lubricator, shut-off valve, soft-start valve • Width dimensions 40, 62 mm (size 4, 6) 	<ul style="list-style-type: none"> • Intelligent air preparation unit for optimizing the use of compressed air as an energy medium in industrial automation technology • Combination of air flow sensor and stop valve with pressure sensor • Identification of production downtime and leakages • Equipped with measuring, control, and diagnostic functions • Fieldbus connection (PROFIBUS DP, PROFINET IO, EtherNet/IP or EtherCAT) via integrated fieldbus nodes enable connection to a higher-level controller • Sustainable operation due to active air shut-off and pressure reduction
online: →	msb4	msb4n	mse6

Product overview

Filter regulator lubricators >

MS series

	 Service unit combinations MSB4-FRC, MSB6-FRC	 Air preparation combination units MSB4N-FRC, MSB6N-FRC
Pneumatic connection 1	G1/2, G1/4, G1/8, G3/8	1/8 NPT, 1/4 NPT, 3/8 NPT, 1/2 NPT
Standard nominal flow rate	850 ... 4800 l/min	800 ... 4800 l/min
Pressure regulation range	0.3 ... 12 bar	0.3 ... 12 bar
Operating pressure	0.8 ... 20 bar	1.5 ... 20 bar
Grade of filtration	5 µm, 40 µm	5 µm, 40 µm
Description	<ul style="list-style-type: none"> Compressed air filter, regulator, and lubricator functions in a single unit High flow rate and highly efficient in removing contaminants Good control characteristics with minimal pressure hysteresis Width dimensions 40, 62 mm (size 4, 6) 	<ul style="list-style-type: none"> Compressed air filter, regulator, and lubricator functions in a single unit High flow rate and highly efficient in removing contaminants Good control characteristics with minimal pressure hysteresis Width dimensions 40, 62 mm (size 4, 6)
online: →	msb4-frc	msb4n-frc



Filter regulators >

Series MS-B

	 Filter regulators MS2-LFR-B, MS4-LFR-B, MS6-LFR-B
Pneumatic connection 1	G1/2, G1/4, M5, QS-6
Standard nominal flow rate	140 ... 5300 l/min
Pressure regulation range [MPa]	0.03 ... 0.7 MPa
Pressure regulation range	0.3 ... 7 bar
Grade of filtration	5 µm, 40 µm
Operating pressure [MPa]	0.1 ... 1 MPa
Operating pressure	1 ... 10 bar
Description	<ul style="list-style-type: none"> Competitively priced basic component with a technical focus Lightweight and robust due to modern polymer materials Compatible with the MS series for the ideal combination of low-cost basic functionality and high-end function requirements Stable control response With or without pressure gauge Rotary knob with latch With integrated secondary venting and primary venting with return flow function MS2: Direct operated diaphragm regulator MS4, MS6: directly controlled piston regulator Width dimension 25, 40, 62 mm (sizes 2, 4, 6)
online: →	ms2-lfr

Filter regulators >



MS series

	 Filter regulating valves MS4-LFR, MS6-LFR, MS9-LFR, MS12-LFR	 Filter regulators MS4N-LFR, MS6N-LFR, MS12N-LFR
Pneumatic connection 1	G1/8, G1/4, G3/8, G1/2, G3/4, G1, Internal, G1/2, G1/4, G1/8, G3/8	1/8 NPT, 1/4 NPT, 3/8 NPT, 1/2 NPT
Standard nominal flow rate	850 ... 24000 l/min	850 ... 7200 l/min
Pressure regulation range	0.3 ... 16 bar	0.3 ... 16 bar
Operating pressure	0 ... 20 bar	0.8 ... 20 bar
Grade of filtration	5 µm, 40 µm	5 µm, 40 µm
Description	<ul style="list-style-type: none"> MS4-LFR, MS6-LFR: directly actuated diaphragm regulator, MS9-LFR: piloted or directly actuated filter-diaphragm regulator, MS12-LFR: piloted diaphragm regulator without internal air consumption Good regulation characteristics with minimal pressure hysteresis and primary pressure compensation Good particle and condensate separation With or without secondary venting High flow rate Lockable rotary knob Return flow option for exhausting from output 2 to input 1 already integrated Variants in accordance with EU Explosion Protection Directive (ATEX) With or without pressure gauge Width dimensions 40, 62, 90, 124 mm (size 4, 6, 9, 12) 	<ul style="list-style-type: none"> Good regulation characteristics with minimal pressure hysteresis and primary pressure compensation Good particle and condensate separation High flow rate Lockable rotary knob Return flow option for exhausting from output 2 to input 1 already integrated Size 4, 6, 12
online: →	ms4-lfr	ms4n-lfr

Product overview

Filter regulators >

Individual devices

	 Filter regulator PCRI	 Compressed air filter regulators PCRPs	 Compressed air filter regulator LFR-EX4
Pneumatic connection 1		1/4 NPT, 1/2 NPT, G1/2, G1/4, NPT1/2-14, NPT1/4-18	1/4 NPT, 1/2 NPT, G1/2, G1/4
Standard nominal flow rate	1400 l/min	1600 ... 4115 l/min	1150 ... 3400 l/min
Pressure regulation range	0.5 ... 8 bar	0.5 ... 12 bar	0.5 ... 16 bar
Grade of filtration	5 µm, 40 µm	5 µm, 40 µm	5 µm, 40 µm
Operating pressure [MPa]	0.1 ... 0.9 MPa	0.1 ... 2 MPa	0.1 ... 2 MPa
Operating pressure	1 ... 9 bar	1 ... 20 bar	1 ... 20 bar
Description	<ul style="list-style-type: none"> • Pneumatic extension module for valve terminal VTOP • Smooths pressure fluctuations and regulates the compressed air to the set outlet pressure • Removes dirt particles from the compressed air that passes through it 	<ul style="list-style-type: none"> • Robust housing for the specific requirements of the process automation industry • Suitable for use outdoors and at temperatures down to -60 °C • Resistant to UV radiation and corrosive environments • Two pressure gauge connections for different installation options • With manual condensate drain, rotating • Size 44, 64 • Sustainable in operation due to reduction of the pressure level 	<ul style="list-style-type: none"> • Sturdy thanks to full metal design • High corrosion resistance (corrosion resistance class CRC 3 to Festo standard 940 070) • Ambient temperature -40 ... +80 °C • Resistant to UV radiation and corrosive environments • With or without pressure gauge • Reliable manual drain • Energy efficient: excellent leakage values • Attractive price • As per EU explosion protection directive (ATEX) • Size: Midi
online: →	pcri	pcrp	lfr





Compressed air filters >

Series MS-B

	 Filter MS2-LF-B
Pneumatic connection 1	M5, QS-6
Standard nominal flow rate	225 ... 250 l/min
Operating pressure	1 ... 10 bar
Grade of filtration	5 µm
Description	<ul style="list-style-type: none"> • Very compact and extremely lightweight series for use close to the process directly in the machine • Lightweight and robust due to modern polymer materials • Compatible with the MS series for the ideal combination of low-cost basic functionality and high-end function requirements • With manual condensate drain, rotating • Variants recommended for production facilities for the manufacture of lithium-ion batteries
online: →	ms2-lf-b

Compressed air filters >





MS series

	 Filters MS4-LF, MS6-LF, MS9-LF, MS12-LF	 Filters MS4N-LF, MS6N-LF, MS12N-LF	 Coalescing filters MS4-LFM-B, MS6-LFM-B, MS9-LFM-B, MS12-LFM-B	 Fine filters MS4N-LFM-B, MS6N-LFM-B, MS12N-LFM-B
Pneumatic connection 1	G3/8, G3/4, G1, Internal, G1/2, G1/4, G1/8, G3/8	1/8 NPT, 1/4 NPT, 3/8 NPT, 1/2 NPT, Internal	Battery module, 1/2 NPT, 3/4 NPT, 1 NPT, 1 1/4 NPT, 1 1/2 NPT, G1, G1 1/2, G1 1/4, G1/2, G1/4, G1/8, G3/4, G3/8	1/8 NPT, 1/4 NPT, 3/8 NPT, 1/2 NPT
Standard nominal flow rate	1000 ... 16000 l/min	1000 ... 4100 l/min		
Operating pressure	0 ... 20 bar	0 ... 20 bar	0 ... 20 bar	0 ... 20 bar
Grade of filtration	5 µm, 40 µm	5 µm, 40 µm	0.01 µm, 1 µm	0.01 µm, 1 µm
Description	<ul style="list-style-type: none"> • Good particle and condensate separation • High flow rate with minimal pressure drop • Available with manual, semi-automatic, fully automatic, or fully automatic, electrically actuated condensate drain • Width dimensions 40, 62, 90, 124 mm (size 4, 6, 9, 12) 	<ul style="list-style-type: none"> • Good particle and condensate separation • High flow rate with minimal pressure drop • Available with manual, semi-automatic, fully automatic, or fully automatic, electrically actuated condensate drain • Size 4, 6, 12 	<ul style="list-style-type: none"> • High-efficiency filter for exceptionally clean compressed air • Removal of oil aerosols from compressed air • Available with differential pressure gauge for indication of contamination • Available with electronic filter pollution indicator • Width dimensions 40, 62, 90, 124 mm (size 4, 6, 9, 12) 	<ul style="list-style-type: none"> • High-efficiency filter for exceptionally clean compressed air • Removal of oil aerosols from compressed air • Available with differential pressure gauge for indication of contamination • Available with electronic filter pollution indicator • Size 4, 6, 12
online: →	ms4-lf	ms4n-lf	ms4-lfm-b	ms4n-lfm

Product overview

Compressed air filters >

MS series

				
	Micro filters MS4-LFM-A, MS6-LFM-A, MS9-LFM-A, MS12-LFM-A	Micro filters MS4N-LFM-A, MS6N-LFM-A, MS12N-LFM-A	Activated carbon filters MS4-LFX, MS6-LFX, MS9-LFX, MS12-LFX	Active carbon filters MS4N-LFX, MS6N-LFX, MS12N-LFX
Pneumatic connection 1	Battery module, 1/2 NPT, 3/4 NPT, 1 NPT, 1 1/4 NPT, 1 1/2 NPT, G1, G1 1/2, G1 1/4, G1/2, G1/4, G1/8, G3/4, G3/8	1/8 NPT, 1/4 NPT, 3/8 NPT, 1/2 NPT	Battery module, 1/2 NPT, 3/4 NPT, 1 NPT, 1 1/4 NPT, 1 1/2 NPT, G1, G1 1/2, G1 1/4, G1/2, G1/4, G1/8, G3/4, G3/8	1/8 NPT, 1/4 NPT, G1/2, G3/8
Standard nominal flow rate			4800 ... 6000 l/min	4800 ... 6000 l/min
Operating pressure	0 ... 20 bar	0 ... 20 bar	0 ... 20 bar	0 ... 20 bar
Grade of filtration	0.01 µm, 1 µm	0.01 µm, 1 µm	0.01 µm, 1 µm	0.01 µm, 1 µm
Description	<ul style="list-style-type: none"> • High-efficiency filter for exceptionally clean compressed air • Removal of oil aerosols from compressed air • Available with differential pressure gauge for indication of contamination • Available with electronic filter pollution indicator • Width dimensions 40, 62, 90, 124 mm (size 4, 6, 9, 12) 	<ul style="list-style-type: none"> • High-efficiency filter for exceptionally clean compressed air • Removal of oil aerosols from compressed air • Available with differential pressure gauge for indication of contamination • Available with electronic filter pollution indicator • Size 4, 6, 12 	<ul style="list-style-type: none"> • Removal of gaseous oil particles from compressed air using activated carbon • Air quality class at the output [1.4.1] to ISO 8573-1 • Eliminates odors and vapors • Residual oil content = 0.003 mg/m³ • Width dimensions 40, 62, 90, 124 mm (size 4, 6, 9, 12) 	<ul style="list-style-type: none"> • Removal of gaseous oil particles from compressed air using activated carbon • Air quality class at the output [1.4.1] to ISO 8573-1 • Eliminates odors and vapors • Residual oil content = 0.003 mg/m³ • Size 4, 6, 12
online: →	ms4-lfm-a	ms4n-lfm	ms4-lfx	ms4n-lfx

Compressed air filters >

Individual devices

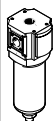
		
	Filter mufflers LFU	Micro filter PFML
Size	G1/2, G1, G1/4, G3/8	90, 186
Grade of filtration	1 µm	0.01 µm
Operating pressure [MPa]	0 ... 1.6 MPa	0 ... 5 MPa
Operating pressure	0 ... 16 bar	0 ... 50 bar
Operating pressure [psi]	0 ... 232 psi	0 ... 725 psi
Flow rate with respect to atmosphere	4000 ... 12500 l/min	
Noise reduction	Reduction by 40 dB	
Description	<ul style="list-style-type: none"> • Removes up to 99.99% of oil and other contaminants from exhaust air • Manual rotary condensate drain • Reduced exhaust noise regardless of frequency 	<ul style="list-style-type: none"> • For high-pressure applications • Food grade www.festo.com/certificates/PFML
online: →	lfu	pfml

Pressure regulators >

Series MS-B







Pressure regulators
MS2-LR-B, MS4-LR-B, MS6-LR-B

Pneumatic connection 1	G1/2, G1/4, M5, QS-6
Standard nominal flow rate	170 ... 6000 l/min
Pressure regulation range	0.3 ... 7 bar
Operating pressure [MPa]	0.1 ... 1 MPa
Operating pressure	1 ... 10 bar
Description	<ul style="list-style-type: none"> • Competitively priced basic component with a technical focus • Lightweight and robust due to modern polymer materials • Compatible with the MS series for the ideal combination of low-cost basic functionality and high-end function requirements • Stable control response • With or without pressure gauge • Rotary knob with latch • With integrated secondary venting and primary venting with return flow function • MS2: Direct operated diaphragm regulator • MS4, MS6: directly controlled piston regulator • Width dimension 25, 40, 62 mm (sizes 2, 4, 6) • Sustainable in operation due to reduction of the pressure level
online: →	ms-lr-b

Product overview





Pressure regulators >

MS series

	 Pressure regulators MS4-LR, MS6-LR, MS9-LR	 Pressure regulators MS4N-LR, MS6N-LR	 Pressure regulators MS12-LR	 Pressure regulators MS12N-LR
Pneumatic connection 1	G1/8, G1/4, G3/8, G1/2, G3/4, G1, G1/2, G1/4, G1/8, G3/8	1/8 NPT, 1/4 NPT, 3/8 NPT, 1/2 NPT, 3/4 NPT	Sub-base	
Standard nominal flow rate	800 ... 30000 l/min	1000 ... 7500 l/min	12000 ... 22000 l/min	12000 ... 22000 l/min
Pressure regulation range	0.1 ... 16 bar	0.3 ... 16 bar	0.15 ... 16 bar	0.15 ... 16 bar
Operating pressure [MPa]	0.08 ... 2 MPa	0.08 ... 2 MPa	0.08 ... 2.1 MPa	0.08 ... 2.1 MPa
Operating pressure	0.8 ... 20 bar	0.8 ... 20 bar	0.8 ... 21 bar	0.8 ... 21 bar
Description	<ul style="list-style-type: none"> • High flow rate with minimal pressure drop • Good regulation characteristics with minimal pressure hysteresis and primary pressure compensation • With or without secondary venting • Lockable rotary knob • Optional pressure sensor and rotary knob pressure gauge • Width dimensions 25, 40, 62, 90 mm (size 2, 4, 6, 9) 	<ul style="list-style-type: none"> • High flow rate with minimal pressure drop • Good regulation characteristics with minimal pressure hysteresis and primary pressure compensation • With or without secondary venting • Lockable rotary knob • Optional pressure sensor and rotary knob pressure gauge • Width dimensions 40, 62 mm (size 4, 6) 	<ul style="list-style-type: none"> • High flow rate with minimal pressure drop • Good regulation characteristics with minimal pressure hysteresis and primary pressure compensation • With secondary venting • Lockable rotary knob • With or without pressure gauge • MS12-LR-...-PO: pneumatically actuated (pressure range determined by pilot regulator) • MS12-LR-...-PE6: solenoid actuated (pilot control by proportional pressure control valve) • Width dimensions 124 mm (size 12) • Sustainable in operation due to reduction of the pressure level 	<ul style="list-style-type: none"> • Standard nominal flow rate <=22.000 l/min with grid dimension 124 mm • High flow rate with minimal pressure drop • Good regulation characteristics with minimal pressure hysteresis and primary pressure compensation • With secondary venting • Lockable rotary knob
online: →	ms4-lr	ms4n-lr	ms12-lr	ms12-lr

Pressure regulators >

MS series

	 Pressure regulators MS4-LRB, MS6-LRB	 Pressure regulators MS4N-LRB, MS6N-LRB	 Precision pressure regulators MS6-LRP, MS6-LRPB	 Precision pressure regulating valves MS6N-LRP, MS6N-LRPB
Pneumatic connection 1	G1/2, G1/4	1/4 NPT, 1/2 NPT	G1/4, G3/8, G1/2, G3/4, 1/4 NPT, 3/8 NPT, 3/4 NPT, G1/2, G1/4, G3/8	G1/4, G3/8, G1/2, G3/4, 1/4 NPT, 3/8 NPT, 1/2 NPT, 3/4 NPT
Standard nominal flow rate	300 ... 7300 l/min	300 ... 7300 l/min	800 ... 9000 l/min	800 ... 9000 l/min
Pressure regulation range	0.3 ... 16 bar	0.3 ... 16 bar	0.05 ... 12 bar	0.05 ... 12 bar
Operating pressure [MPa]			0.1 ... 1.4 MPa	0.1 ... 1.4 MPa
Operating pressure	0.8 ... 20 bar	0.8 ... 20 bar	1 ... 14 bar	1 ... 14 bar
Description	<ul style="list-style-type: none"> • To build up a regulator manifold with through air supply for pressure ranges that can be adjusted independently of one another • Good regulation characteristics with minimal pressure hysteresis and primary pressure compensation • Lockable rotary knob • With or without secondary venting • Integrated return flow option for exhausting from output 2 to input 1 • Optional pressure sensor and rotary knob pressure gauge • Variants in accordance with EU Explosion Protection Directive (ATEX) • Width dimensions 40, 62 mm (size 4, 6) 	<ul style="list-style-type: none"> • To build up a regulator manifold with through air supply for pressure ranges that can be adjusted independently of one another • Good regulation characteristics with minimal pressure hysteresis and primary pressure compensation • Lockable rotary knob • With or without secondary venting • Integrated return flow option for exhausting from output 2 to input 1 • Optional pressure sensor and rotary knob pressure gauge • Variants in accordance with EU Explosion Protection Directive (ATEX) • Width dimensions 40, 62 mm (size 4, 6) 	<ul style="list-style-type: none"> • As individual device and for manifold assembly with through air supply • Good regulation characteristics with minimal pressure hysteresis and primary pressure compensation • High secondary venting • Lockable rotary knob • Optional pressure sensor and rotary knob pressure gauge • Width dimensions 62 mm (size 6) 	<ul style="list-style-type: none"> • As individual device and for manifold assembly with through air supply • Good regulation characteristics with minimal pressure hysteresis and primary pressure compensation • High secondary venting • Lockable rotary knob • Optional pressure sensor and rotary knob pressure gauge • Width dimensions 62 mm (size 6)
online: →	ms4-lrb	ms4n-lrb	ms6-lrp	ms6n-lrp

Product overview

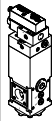

Pressure regulators >

Individual devices

	 Precision pressure regulators LRP, LRPS	 Electric pressure regulators PREL
Pneumatic connection 1	For sub-base Ø 7 mm, G1/4, G1/8	G1
Standard nominal flow rate	240 ... 2300 l/min	
Pressure regulation range	0.05 ... 10 bar	0.4 ... 40 bar
Operating pressure [MPa]	0.1 ... 1.2 MPa	0 ... 5 MPa
Operating pressure	1 ... 12 bar	0 ... 50 bar
Description	<ul style="list-style-type: none"> • Lockable design • Good regulation characteristics with minimal pressure hysteresis and primary pressure compensation • High secondary venting • Variants in accordance with EU Explosion Protection Directive (ATEX) • Variants recommended for production facilities for the manufacture of lithium-ion batteries 	<ul style="list-style-type: none"> • For high-pressure applications • Food grade see www.festo.com/certificates/PREL • Sizes: 90 mm, 186 mm
online: →	lrp	prel



Compressed air lubricator >

MS series

	 Lubricators MS4-LOE, MS6-LOE, MS9-LOE, MS12-LOE	 Lubricators MS4N-LOE, MS6N-LOE, MS12N-LOE
Pneumatic connection 1	G3/8, G3/4, G1, Internal, G1/2, G1/4, G1/8, G3/8	1/8 NPT, 1/4 NPT, 3/8 NPT, 1/2 NPT
Standard nominal flow rate	1100 ... 27000 l/min	1100 ... 7200 l/min
Operating pressure	1 ... 16 bar	1 ... 16 bar
Minimum flow rate for lubricator function	40 ... 400 l/min	40 ... 400 l/min
Description	<ul style="list-style-type: none"> • Proportional air line lubricator with precision oil metering • Quick and easy top-up even under pressure • Oil capacity 30 ... 1500 cm³ • Width dimensions 40, 62, 90, 124 mm (size 4, 6, 9, 12) 	<ul style="list-style-type: none"> • Proportional air line lubricator with precision oil metering • Quick and easy top-up even under pressure • Oil capacity 30 ... 1500 cm³ • Width dimensions 40, 62, 124 mm (size 4, 6, 12)
online: →	ms4-loe	ms4n-loe

On-off and soft start valves >





Series MS-B

	 On/off valves MS4-EE-B, MS6-EE-B	 Pressure build-up valves MS4-EDE-B, MS6-EDE-B
Design	Poppet valve, electrically actuated	Poppet valve, electrically actuated
Pneumatic connection 1	G1/4, G1/2, G1/2, G1/4	G1/4, G1/2, G1/2, G1/4
Operating pressure [MPa]	0.3 ... 0.7 MPa	0.3 ... 0.7 MPa
Operating pressure	3 ... 7 bar	3 ... 7 bar
Standard nominal flow rate	2000 ... 5000 l/min	2000 ... 5000 l/min
Exhaust air function	Without flow control option	Without flow control option
Electrical connection	Form C, as per EN 175301-803	Form C, as per EN 175301-803
Description	<ul style="list-style-type: none"> • Very compact and extremely lightweight series for use close to the process directly in the machine • Electrically operated 3/2-way valve for pressurizing and exhausting pneumatic systems • Ducted exhaust air possible via threaded connection with silencer • Detenting and non-detenting manual override • Supply voltage 24 V DC • With solenoid coil, without plug socket • Variants recommended for production facilities for the manufacture of lithium-ion batteries • Width dimensions 40, 62 mm (size 4, 6) 	<ul style="list-style-type: none"> • Very compact and extremely lightweight series for use close to the process directly in the machine • Electrically operated 3/2-way valve for slow pressurizing and exhausting of pneumatic systems • Switch-through pressure can be precisely controlled via solenoid valve • Adjustable switch-through time delay • Built-in connections into which the tubing can be directly inserted • Detenting and non-detenting manual override • Supply voltage 24 V DC • With solenoid coil, without plug socket • Variants recommended for production facilities for the manufacture of lithium-ion batteries • Width dimensions 40, 62 mm (size 4, 6)
online: →	ms-ee-b	ms-ed-e-b

Product overview





On-off and soft start valves >

MS series

	 Soft-start/quick exhaust valves MS6-SV-E, MS6-SV-D	 Soft-start/quick exhaust valves MS6-SV-C, MS9-SV-C	 Soft-start/quick exhaust valves MS6N-SV, NPT	 On/off valves MS4-EM1, MS6-EM1, MS9-EM, MS12-EM
Pneumatic connection 1	G1/2	G1/2		Battery module, G3/8, G3/4, G1, G1/2, G1/4, G1/8, G3/8
Standard nominal flow rate	4300 ... 16550 l/min	4300 ... 16550 l/min	4300 ... 5700 l/min	1200 ... 32000 l/min
Operating pressure	3 ... 16 bar	3 ... 16 bar	3 ... 10 bar	0 ... 20 bar
Actuation type	Electrical	Electrical	Electrical	Manual
Description	<ul style="list-style-type: none"> • With safety functions • For reducing pressure quickly and reliably and for building up pressure gradually • Adjustable pressure build-up time • Available with muffler • Supply voltage 24 V DC • Width dimensions 62 mm (size 6) 	<ul style="list-style-type: none"> • With safety functions • For reducing pressure quickly and reliably and for building up pressure gradually • Adjustable pressure build-up time • Adjustable switch-through pressure • Supply voltage 24 V DC • Width dimensions 62, 90 mm (size 6, 9) 	<ul style="list-style-type: none"> • With NPT connecting thread • With safety functions • For reducing pressure quickly and reliably and for building up pressure gradually • Adjustable pressure build-up time • Adjustable switch-through pressure • Supply voltage 24 V DC 	<ul style="list-style-type: none"> • Manual 3/2-way valve for pressurizing and exhausting pneumatic installations • A muffler can be attached or the exhaust air can be ducted at port 3 • Switching position is immediately recognizable • With optional pressure gauge and pressure sensor • Variants in accordance with EU Explosion Protection Directive (ATEX) • Variants recommended for production facilities for the manufacture of lithium-ion batteries • Width dimensions 40, 62, 90, 124 mm (size 4, 6, 9, 12)
online: →	ms6-sv-e	ms6-sv-c	ms6n-sv	ms4-em1

On-off and soft start valves >



MS series

	 On/off valves MS4N-EM1	 On/off valves MS4-EE, MS6-EE, MS9-EE, MS12-EE	 On/off valves MS4N-EE, MS6N-EE, MS12N-EE	 Soft-start valves MS4-DL, MS6-DL, MS12-DL
Pneumatic connection 1	1/8 NPT, 1/4 NPT, 3/8 NPT, 1/2 NPT	Battery module, G1/8, G1/4, G3/8, G1/2, G3/4, G1, G1/2, G1/4, G1/8, G3/8	1/8 NPT, 1/4 NPT, 3/8 NPT, 1/2 NPT	Battery module, G1/2, G1/4, G1/8, G3/8
Standard nominal flow rate	1200 ... 32000 l/min	1000 ... 32000 l/min	1000 ... 32000 l/min	1000 ... 42000 l/min
Operating pressure	0 ... 20 bar	3 ... 18 bar	3 ... 18 bar	2 ... 20 bar
Actuation type	Manual	Electrical	Electrical	Pneumatic
Description	<ul style="list-style-type: none"> • Manual 3/2-way valve for pressurizing and exhausting pneumatic installations • A muffler can be attached or the exhaust air can be ducted at port 3 • Switching position is immediately recognizable • With optional pressure gauge and pressure sensor • Width dimensions 40, 62, 124 mm (size 4, 6, 12) 	<ul style="list-style-type: none"> • Electric 3/2-way valve for pressurizing and venting pneumatic installations • A muffler can be attached or the exhaust air can be ducted at port 3 • Supply voltage 24 V DC, 110, 230 V AC • With optional pressure gauge and pressure sensor • With solenoid coil, without plug socket • Variants in accordance with EU Explosion Protection Directive (ATEX) • Width dimensions 40, 62, 90, 124 mm (size 4, 6, 9, 12) 	<ul style="list-style-type: none"> • Electric 3/2-way valve for pressurizing and venting pneumatic installations • A muffler can be attached or the exhaust air can be ducted at port 3 • Supply voltage 24 V DC, 110, 230 V AC • With optional pressure gauge and pressure sensor • With solenoid coil, without plug socket • Width dimensions 40, 62, 124 mm (size 4, 6, 12) 	<ul style="list-style-type: none"> • 2/2-way valve for slowly pressurizing pneumatic installations (for use with shut off valve EM(1) and EE) • For building up pressure gradually • Adjustable pressure build-up time • Variants in accordance with EU Explosion Protection Directive (ATEX) • Width dimensions 40, 62, 124 mm (size 4, 6, 12)
online: →	ms4n-em	ms4-ee	ms4n-ee	ms4-dl

Product overview



On-off and soft start valves >

MS series

	 Soft-start valves MS4N-DL, MS6N-DL, MS12N-DL	 Soft-start valves MS4-DE, MS6-DE, MS12-DE	 Soft-start valves MS4N-DE, MS6N-DE, MS12N-DE
Pneumatic connection 1	1/4 NPT, 3/8 NPT, 1/2 NPT	Battery module, G1/2, G1/4, G3/8	1/8 NPT, 1/4 NPT, 3/8 NPT, 1/2 NPT
Standard nominal flow rate	1000 ... 42000 l/min	1000 ... 42000 l/min	1000 ... 42000 l/min
Operating pressure	2 ... 20 bar	3 ... 18 bar	3 ... 18 bar
Actuation type	Pneumatic	Electrical	Electrical
Description	<ul style="list-style-type: none"> • 2/2-way valve for slowly pressurizing pneumatic installations (for use with shut off valve EM(1) and EE) • For building up pressure gradually • Adjustable pressure build-up time • Width dimensions 40, 62, 124 mm (size 4, 6, 12) 	<ul style="list-style-type: none"> • 2/2-way valve for slowly pressurizing pneumatic systems with electrically switchable pressure switchover point • Supply voltage 24 V DC, 110, 230 V AC • Switchable pressure switching point • For advancing the actuators slowly and reliably into the initial position • For avoiding sudden and unexpected movements • Adjustable pressure build-up time • Variants in accordance with EU Explosion Protection Directive (ATEX) • Width dimensions 40, 62, 124 mm (size 4, 6, 12) 	<ul style="list-style-type: none"> • 2/2-way valve for slowly pressurizing pneumatic systems with electrically switchable pressure switchover point • Supply voltage 24 V DC, 110, 230 V AC • Switchable pressure switching point • For advancing the actuators slowly and reliably into the initial position • For avoiding sudden and unexpected movements • Adjustable pressure build-up time • Width dimensions 40, 62, 124 mm (size 4, 6, 12)
online: →	ms4n-dl	ms4-de	ms4n-de



On-off and soft start valves >

Individual devices

	 On-off valves HE-LO	 On/off valves PVEL
Pneumatic connection 1	3/8 NPT, 1/2 NPT, 3/4 NPT, 1 NPT, G1, G1/2, G3/4, G3/8	
Standard nominal flow rate	5200 ... 10000 l/min	
Nominal width DN		54
Operating pressure [MPa]		0 ... 5 MPa
Operating pressure	1 ... 10 bar	0 ... 50 bar
Actuation type	Manual	Manual, Pneumatic
Description	<ul style="list-style-type: none"> • For shutting off the compressed air supply whilst simultaneously exhausting systems powered by compressed air • Can be locked in the closed position • Screwed into piping, through-holes for wall mounting • To OSHA 29 CFR 147 	<ul style="list-style-type: none"> • Food grade see www.festo.com/certificates/PVEL • For high-pressure applications
online: →	he-lo	pvel

Air dryers >

MS series

		
	Membrane air dryers MS4-LDM1, MS6-LDM1	Membrane air dryer MS4N-LDM1, MS6N-LDM1
Pneumatic connection 1	G1/2, G1/4	1/8 NPT, 1/4 NPT, 3/8 NPT, 1/2 NPT
Standard nominal flow rate	50 ... 400 l/min	50 ... 400 l/min
Operating pressure	3 ... 12.5 bar	3 ... 12.5 bar
Pressure dew point reduction	see documentation on the Internet	20 K
Description	<ul style="list-style-type: none"> • End-position air dryer with excellent operational reliability • Suitable for use as an individual device or for integration into existing air preparation unit combinations • Flow rate-dependent dew point reduction • Wear-free function requiring no external energy • Width dimensions 40, 62 mm (size 4, 6) 	<ul style="list-style-type: none"> • End-position air dryer with excellent operational reliability • Suitable for use as an individual device or for integration into existing air preparation unit combinations • Flow rate-dependent dew point reduction • Wear-free function requiring no external energy • Width dimensions 40, 62 mm (size 4, 6)
online: →	ms4-ldm1	ms4n-ldm1

Air dryers >





Air dryers: individual devices

	
	Adsorption dryers PDAD
Pneumatic connection 1	G1/2, G3/8
Inlet pressure 1	4 ... 16 bar
Pressure dew point	-40°C
Description	<ul style="list-style-type: none"> • Ideal for decentralized compressed air drying • Integrated filtering of oil and particulates • Defined pressure dew point • Low purge air consumption
online: →	pdad

Product overview

Compressed air distributors >

MS series

				
	Distribution blocks MS4-FRM, MS6-FRM, MS9-FRM, MS12-FRM	Branching modules MS4N-FRM, MS6N-FRM, MS12N-FRM	Distributor blocks MS4-FRM-FRZ, MS6-FRM-FRZ	Distributor blocks MS4N-FRM-FRZ, MS6N-FRM-FRZ
Pneumatic connection 1	G1/4, G1/2, G1, G2, Battery module, 1/2 NPT, 3/4 NPT, 1 NPT, 1 1/4 NPT, 1 1/2 NPT, G1, G1 1/2, G1 1/4, G1/2, G1/4, G1/8, G3/4, G3/8	1/4 NPT, 1/2 NPT, 2 NPT, Battery module, 1/8 NPT, 3/8 NPT	G1/4, G1/2	1/4 NPT, NPT1/2-14
Standard nominal flow rate in main flow direction 1 -> 2	1200 ... 50000 l/min	1200 ... 42000 l/min	4050 ... 14600 l/min	4050 ... 14600 l/min
Operating pressure	0 ... 20 bar	0 ... 20 bar	0 ... 20 bar	0 ... 20 bar
Description	<ul style="list-style-type: none"> • With optional integrated non-return function and pressure switch • Outlet at top and bottom • Can be used as an intermediate distributor for varying air qualities • Available with pressure sensor • Variants recommended for production facilities for the manufacture of lithium-ion batteries • Width dimensions 40, 62, 90, 124 mm (size 4, 6, 9, 12) 	<ul style="list-style-type: none"> • With optional integrated non-return function and pressure switch • Outlet at top and bottom • Can be used as an intermediate distributor for varying air qualities • Available with pressure sensor • Width dimensions 40, 62, 124 mm (size 4, 6, 12) 	<ul style="list-style-type: none"> • Slim compressed air distributor • Outlet at top and bottom • Can be used as an intermediate distributor for varying air qualities • Can be used as an adapter between two pressure regulators with large rotary knob with pressure gauge of size 4 • Width dimensions 40, 62 mm (size 4, 6) 	<ul style="list-style-type: none"> • Slim compressed air distributor • Outlet at top and bottom • Can be used as an intermediate distributor for varying air qualities • Can be used as an adapter between two pressure regulators with large rotary knob with pressure gauge of size 4 • Width dimensions 40, 62 mm (size 4, 6)
online: →	ms*-frm	ms4n-frm	ms*-frm-frz	ms4n-frm-frz

Compressed air distributors >

Individual devices

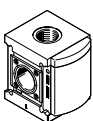

	
	Branching modules PMBL
Pneumatic connection 3	G1
Pneumatic connection 4	G1
Operating pressure [MPa]	0 ... 5 MPa
Operating pressure	0 ... 50 bar
Description	<ul style="list-style-type: none"> • For high-pressure applications • Food grade see www.festo.com/certificates/PMBL • Sizes: 90 mm, 186 mm
online: →	pmbL

Generators

	
	Pressure vacuum generators PGVA
Output pressure 1 [Mpa]	-0.062 MPa, -0.045 MPa
Output pressure 2 [Mpa]	0.045 MPa, 0.08 MPa
Pneumatic connection 1	QS-4
Display	LED
Configuration support	CODESYS V3, Python scripts, Integrated web server
Electrical power consumption	11 W, 19 W
Nominal operating voltage DC	24 V
Electrical actuation	COM port, Ethernet, Integrated controller
Description	<ul style="list-style-type: none"> • Complete solution with integrated compressor • Proportional pressure/vacuum regulation or preset fixed values • Power supply 24 V DC • Flexible to use and easy to integrate • Easy to operate and configure with the GUI configuration tool, see www.festo.com/software/PGVA • Dynamic and precise • Sustainable operation thanks to consumer-optimized, decentralized pressure generation
online: →	pgva

Condensate drain >



MS series

		
	Water traps MS6-LWS, MS9-LWS, MS12-LWS	Water trap MS6N-LWS
Pneumatic connection 1	G1/2, G1/4, G3/8	1/4 NPT, 3/8 NPT, 1/2 NPT
Operating pressure	0.8 ... 16 bar	0.8 ... 16 bar
Description	<ul style="list-style-type: none"> • No replacement of filter cartridges necessary • Constantly high condensate separation (99%) up to the maximum flow rate • Available with fully automatic or fully automatic, electrically actuated condensate drain 	<ul style="list-style-type: none"> • With NPT connecting thread • No replacement of filter cartridges necessary • Constantly high condensate separation (99%) up to the maximum flow rate • Available with fully automatic or fully automatic, electrically actuated condensate drain
online: →	ms6-lws	ms6n-lws

Product overview

Condensate drain >

Individual devices





		
	Condensate drains, electric PWEA	Condensate drains, automatic WA
Pneumatic connection	G1/2	M9
Operating pressure	0.8 ... 16 bar	1.5 ... 16 bar
Description	<ul style="list-style-type: none"> Fully automatic condensate drain with independent electrical controller Interface for communicating with master control device Reliable thanks to non-contacting capacitive sensor Can be used with air preparation units or simply in piping systems Ready status and switching status indicated via LEDs and electrical interface 	<ul style="list-style-type: none"> For attachment to air preparation units and compressed air networks/systems Automatic emptying after the max. fill level has been reached Automatic emptying after the operating pressure $p < 0.5$ bar is switched off Manual actuation during operation is possible
online: →	pwea	wa

Air booster



Pressure boosters

	
	Pressure boosters DPA
Pneumatic connection 1	G1/2, G1/4, G3/8, QS-10, QS-12, QS-16
Outlet pressure 2	4 ... 16 bar
Inlet pressure 1	2 ... 10 bar
Description	<ul style="list-style-type: none"> Pneumatic pressure increase up to the double inlet pressure Optionally as pressure booster/air pressure reservoir combinations Any mounting position Short filling times Long service life Compact design Available with sensing option
online: →	dpa

Pressure gauge

	 Pressure gauges PAGN	 Pressure gauges MA	 Flanged pressure gauge FMA	 Flanged precision pressure gauges, precision pressure gauges FMAP, MAP
Type of mounting	Front panel mounting, Line installation	Line installation	Front panel mounting	Front panel mounting, Line installation
Indicating range [MPa]	0 ... 1.6 MPa	0 ... 1.6 MPa		
Display range	0 ... 16 bar	0 ... 25 bar	0 ... 16 bar	0 ... 16 bar
Display range [psi]	0 ... 232 psi	0 ... 362.5 psi	0 ... 232 psi	0 ... 232 psi
Pneumatic connection	G1/8 with sealing ring, G1/4, Cartridge 10, G1/4, R1/8	G1/4, G1/8, M5, QS-4, QS-6, QS-8, R1/4, R1/8	G1/4	G1/4, R1/8
Operating pressure [MPa]	0 ... 1.6 MPa	0 ... 2.5 MPa	0 ... 1.6 MPa	0 ... 1.6 MPa
Operating pressure	0 ... 16 bar	0 ... 25 bar	0 ... 16 bar	0 ... 16 bar
Operating pressure [psi]	0 ... 232 psi	0 ... 362.5 psi	0 ... 232 psi	0 ... 232 psi
Measurement accuracy class	1, 1.6, 2.5, 4, 5	1.6, 2.5, 4, 5	1.6, 2.5	1, 1.6
Description	<ul style="list-style-type: none"> • Designs based on EN 837-1 • Display units bar, psi, MPa 	<ul style="list-style-type: none"> • Designs based on DIN EN 837-1, with optional red-green range • Pneumatic connection via R, metric, or G thread, push-in connector • Display units bar, psi, MPa 	<ul style="list-style-type: none"> • Designs based on EN 837-1 • Pneumatic connection via G thread • Display units bar, psi 	<ul style="list-style-type: none"> • Designs based on EN 837-1 • Pneumatic connection via R or G thread • Display units bar, psi
online: →	pagn	ma	fma	fmap

Pressure gauge

	 Pressure gauge kits DPA	 Vacuum gauges VAM, FVAM	 Pressure gauge PAGL
Type of mounting	With external thread	Front panel mounting, Screw-in	Line installation
Indicating range [MPa]			0 ... 6 MPa
Display range		-1 ... 9 bar	0 ... 60 bar
Display range [psi]		0 ... 130 psi	0 ... 870 psi
Pneumatic connection	G1/4, G1/8, R1/8	G1/4, G1/8, R1/4, R1/8	G1/4
Operating pressure [MPa]			0 ... 6 MPa
Operating pressure	10 ... 16 bar	-1 ... 9 bar	0 ... 60 bar
Operating pressure [psi]			0 ... 870 psi
Measurement accuracy class	2.5, 4	2.5	1.6
Description	<ul style="list-style-type: none"> • For pressure booster DPA • For monitoring the inlet and outlet pressure • Pneumatic connection via R or G thread 	<ul style="list-style-type: none"> • Designs based on DIN EN 837-1, with optional red-green range • Pneumatic connection via R or G thread • Double or single scale • Display units bar, in Hg, psi 	<ul style="list-style-type: none"> • For high-pressure applications • Display units bar, psi, MPa
online: →	dpa	vam	pagl

Product overview

Customized components – for your specific requirements

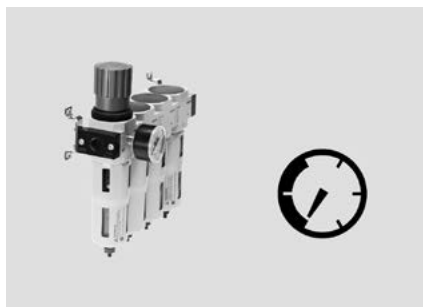

Components for compressed air preparation with customized designs

Can't find the compressed air preparation components you need in our catalog?

We can offer you customized components that are tailored to your specific requirements.

Common product modifications:

- Modified pressure range
- Rotary knob: in a special color, with protection against rotation
- Fitting: integrated throttling port, special thread
- Tubing with special printing
- Pressure gauge with red/green range

Many additional variants are possible.

Ask your Festo sales engineer, who will be happy to help:

→ www.festo.com/contact



Product overview

Software tools

Configurator for connecting cable NEBA



Design a product with a number of features quickly and reliably with the help of the configurator.

Select all the required product features step-by-step.

The use of logic checks ensures that only correct configurations are available for selection.





A dynamic graphic generated based on the configuration provides visual assistance in selecting the correct product features.

You will find the configurator

- at www.festo.com/catalogue/neba
- Click the product
- Click the blue „Configure product“ button

Connecting cables >



Connecting cables, universal

				
	Connecting cables NEBA	Connecting cables NEBU-G78W5-K	Connecting cable M12x1 A-coded, 8-pin NEBU-M12W8-K, SIM-M12	Connecting cable M12x1 A-coded, 1 mm² NEBU-M12G5-E
Electrical connection, connection type	Socket, Cable, Plug	Socket, Cable	Socket, Cable, Plug	Socket, Cable, Plug
Electrical connection, cable outlet	Straight, straight, angled, Angled	Angled	Straight, Angled	Straight
Electrical connection, design	Round	Round	Round	Round
Electrical connection, connection technology	M12x1 A-coded as per EN 61076-2-101, M8x1 A-coded as per EN 61076-2-104, Open end, Diameter 8 mm, A-coded according to EN 61076-2-104	G7/8 coded as per NFPA/ T3.5.29 R1-2007, Open end	M12x1 A-coded as per EN 61076-2-101, Open end	M12x1 A-coded as per EN 61076-2-101, Open end
Electrical connection, number of pins/wires	3, 4, 5	5	8	5
Cable length	0.3 ... 30 m	2 m	2 ... 25 m	5 ... 10 m
Description	<ul style="list-style-type: none"> • Powerful universally applicable connecting cables • Suitable for harsh environments and applications in constant motion or vibration • Meets IEC 61010-1 and IEC 61010-2-202 safety requirements for electrical equipment for measurement, control and laboratory use • High IP65, IP68, IP69k degree of protection • Resistant to abrasion and low adhesion • Suitable for use with energy chain and robot lines • Flame-retardant and self-extinguishing • Recommended for production systems for the manufacture of Li-ion batteries (F1A) 	<ul style="list-style-type: none"> • Connecting cables with 5-pin plug/socket M12x1 A-coded according to EN 61076-2-101 and conductor nominal cross-section 1 mm² (NEBU-M12G5-E-...-Q8N-...) • Shielded connecting cables with 8-pin angled socket M12x1 A-coded according to EN 61076-2-101 (NEBU-M12W8-K-...) • Connecting cable with power supply socket G7/8 coded according to NFPA/T3.5.29 R1-2007 (NEBU-G78W5-...) 	<ul style="list-style-type: none"> • Shielded connecting cables with 8-pin sockets M12x1 A-coded in accordance with EN 61076-2-101 • Cable length 2 ... 25 m 	<ul style="list-style-type: none"> • Connecting cables with 5-pin plug/socket M12x1 A-coded according to EN 61076-2-101 • Nominal conductor cross-section 1mm² • Cable length 5 ... 10 m
online: →	neba	nebu	m12_m8	m12_1

Product overview

Connecting cables >

Connecting cables for control systems

	 Connecting cables NEBC	 Connecting cables NEBP	 Connecting cables NEBL
Cable diameter	4.6 ... 10.8 mm	5.5 mm	4.8 ... 6.75 mm
Electrical connection	25-pin, 5-pin, Plug, straight, Straight plug/open end, Sub-D / -, Sub-D/Sub-D, Square design/angled, M12x1		
Electrical connection, connection type	Socket, Hybrid plug, Cable, Plug, Plug and socket strip	Socket, Plug	Socket, Cable, Plug
Electrical connection, cable outlet	Straight, Angled	Angled	Straight, Angled
Electrical connection, design	Rectangular, Round	Round	Round
Electrical connection, connection technology	Plug pattern P1, M12x1 A-coded as per EN 61076-2-101, M12x1, with Festo-specific coding, Connection diagram form A as per EN 175301-803, M8x1, D-coded as per EN 61076-2-114, M12x1, D-coded as per EN 61076-2-101, M9x0.5, RJ45 as per IEC 60603-7-3, USB 2.0, type A, Open end, M8x1 A-coded as per EN 61076-2-104, RJ45, RJ45 and socket strip, 12 pins, 2 rows, Sub-D, USB 2.0 type B	M9x0.5, M16x0.75	M8x1 A-coded as per EN 61076-2-104, M12x1, T-coded as per EN 61076-2-111, Open end
Electrical connection, number of pins/wires	3, 4, 5, 8, 9, 17, 20, 25, 26	5, 6	4
Cable length	0.2 ... 50 m	2 m	0.3 ... 15 m
Description	<ul style="list-style-type: none"> • Variants in easy-to-clean design • Variants that are default, with shielding or as a hybrid cable • Variants suitable for energy chains • Variants with EtherNet, CANopen, I-Port or RS232 	<ul style="list-style-type: none"> • Connection between linear potentiometer MME and measuring module CPX-CMIX 	<ul style="list-style-type: none"> • For power supply • Suitable for energy-chains
online: →	nebc	nebp	nebl

Connecting cables >

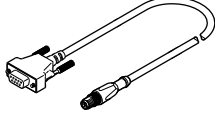

Connecting cables for motors

	 Motor, encoder, resolver cables NEBM	 Fieldbus adapters FBA
Electrical connection, connection type	4x socket, 4x cables, Socket, Hybrid socket, Hybrid plug, Cable, Plug, Plugs and cables	Socket, Plug
Electrical connection, cable outlet	Straight, Angled	Straight
Electrical connection, design	Rectangular, Round	Rectangular, Round
Electrical connection, connection technology	Connection diagram F1, Connection diagram H6, coded for motor, Connection diagram H7, coded for motor brake, Plug pattern L5, Plug pattern L10, Connection diagram L15, Connection diagram L5, Connection diagram RE, ITT M3, M12x1 A-coded as per EN 61076-2-101, RJ45 and open end, Sub-D, Sub-D and open end, M12x1, T-coded as per EN 61076-2-111, M17x0.75, Open end, M23x1, M40x1, M40x1.5	M12x1 A-coded as per EN 61076-2-101, Sub-D
Electrical connection, number of pins/wires	2, 4, 6, 8, 9, 12, 14, 15, 21, 24, 28, 31	5, 9
Cable length	0.2 ... 100 m	0.1 m
Description	<ul style="list-style-type: none"> • Fits perfectly into our holistic product portfolio of electromechanical actuators, motors, drive controllers and control systems • For servo and stepper motors • For motor controllers CMMS-ST, CMMP-AS • For servo drive • Can be used in a wide temperature range • Suitable for energy chains 	<ul style="list-style-type: none"> • 9-pin Sub-D plug to 5-pin round plug/M12 socket • For CANopen and DeviceNet
online: →	nebm	fba

Product overview



Connecting cables >

Connecting cables for valves

	 Connecting cables/plug sockets with cable NEBV	 Plug sockets with cable KMEB-1, KMEB-2, KMEB-3	 Connection/socket cables KMPYE-AIF, KMPYE-5
Electrical connection	4-pin/2-wire, 4-pin/3-pin, 44-pin, Socket, Angled socket/cable, Angled socket/straight plug, M8x1/M8x1, Sub-D, M8x1	4-pin, 5-pin, Socket, angled, Form C, as per DIN EN 175301-803	
Electrical connection, connection type	2x single wires, Socket, Socket, narrow, Cable with socket, Cable, Plug, Twin wire	Socket	Socket, Cable, Plug
Electrical connection, cable outlet	Straight, Angled	Angled	Straight
Electrical connection, design	Rectangular, Round	Rectangular	Round
Electrical connection, connection technology	Connection diagram ZB, self-tapping screw, Connection diagram ZC, self-tapping screw, Connection diagram ZC, metric screw, Connection diagram H, Port pattern HP, Connection diagram Q7, M12x1 A-coded as per EN 61076-2-101, Connection diagram S, Connection diagram form A based on EN 175301-803, Connection diagram form B as per industrial standard, 11 mm, Connection diagram type C as per EN 175301-803, M8x1 A-coded as per EN 61076-2-104, Open end, Sub-D	Open end	M12x1 A-coded as per EN 61076-2-101, M9x0.5, Open end
Electrical connection, number of pins/wires	2, 3, 4, 5, 8, 10, 25, 26, 27, 36, 37, 44	2, 3	4, 7
Cable length	0.1 ... 30 m	0.5 ... 10 m	0.3 ... 5 m
Description	<ul style="list-style-type: none"> • For solenoid coils form A, form B or form C • For solenoid coils with thread M8x1 or M12x1 A-coded • For solenoid coils ZC or various special port patterns • Pre-assembled at one or both ends • Cable length 0.1 ... 30 m • With PUR cable • Ambient temperature -25 ... +80 °C 	<ul style="list-style-type: none"> • For solenoid coils with plug pattern form C according to EN 175301-803 • For EB solenoid coils • With PVC or PUR cable • Ambient temperature -20 ... +80 °C 	<ul style="list-style-type: none"> • For solenoid coils with thread M12x1 A-coded according to EN 61076-2-101 • For connection of Proportional directional control valves MPYE with end-position controller SPC11 • Cable length 0.3 ... 5 m • With PVC or PUR cable • Ambient temperature -25 ... +80 °C
online: →	nebv	kmeb-1	kmpye



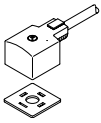

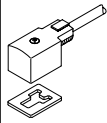
Connecting cables >

Connecting cables for valves

	 Plug sockets with cable KME	 Connecting cables KMC	 Plug sockets with cable KMF	 Plug sockets with cable KMV
Type of mounting	On air solenoid valve with M3 central screw	On air solenoid valve with M3 central screw	On air solenoid valve with M3 central screw	On air solenoid valve with M3 central screw
Signal status display	LED yellow			
Electrical connection 1	Angled socket, rectangular design, 3-pin, form C			
Electrical connection 2	Open end, 2-wire			
Nominal operating voltage DC	24 V	24 V	24 V	24 V
DC operating voltage range				
Description	<ul style="list-style-type: none"> For solenoid coils with plug pattern form C as per industrial standard, 9.4 mm For E solenoid coils With PVC cable Ambient temperature -20 ... +80 °C 	<ul style="list-style-type: none"> For solenoid coils with plug pattern form A according to EN 175301-803 For D solenoid coils For N1 solenoid coils With PVC cable Ambient temperature -20 ... +80 °C 	<ul style="list-style-type: none"> For solenoid coils with plug pattern form B as per industrial standard, 11 mm For F solenoid coils With PVC cable Ambient temperature -20 ... +80 °C 	<ul style="list-style-type: none"> For solenoid coils with plug pattern form B according to EN 175301-803 For V solenoid coils With PVC cable Ambient temperature -20 ... +80 °C
online: →	kme	kmc	kmf	kmv

Connecting cables >

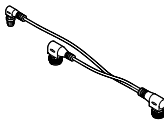



Connecting cables for valves

	 Connecting cables/plug sockets with cable KMYZ-2, KMYZ-4	 Electrical plug-in bases MHAP-PI	 Connecting cables NEDV	 Connecting cables MHJ9-KMH
Type of mounting	On air solenoid valve with M2 central screw, On air solenoid valve with self-tapping screw	Clip		Optionally:, With through-hole, With H-rail
Signal status display				
Electrical connection 1			2x angled socket, M12, 3-pin	
Electrical connection 2			Angled plug, M8, 4-pin	
Nominal operating voltage DC	24 V			
DC operating voltage range	3 ... 36 V	≤60 V	0 ... 30 V	12 ... 53 V
Description	<ul style="list-style-type: none"> For solenoid coils with plug pattern ZB For solenoid coils with plug pattern ZC With PVC or PUR cable Ambient temperature -10 ... +50 °C 	<ul style="list-style-type: none"> Electrical plug-in base with plug pattern H For sub base valves and semi in-line valves MHA1-...-PI and MHP1-...-PI Pre-assembled Ambient temperature -20 ... +80 °C 	<ul style="list-style-type: none"> For proportional valves VPWP For connecting to sub-base VABP-S3 Pre-assembled With PUR cable Ambient temperature -25 ... +80 °C 	<ul style="list-style-type: none"> With control electronics for solenoid valves MHJ9 With plug sockets KMH With PVC cable Ambient temperature -5 ... +50 °C
online: →	kmyz-2	mhap	nedv	mhj9-kmh

Product overview





Connecting cables >

Connecting cables for valve terminals

	 Connecting cables NEBV-S1, NEBV-C	 Connecting cables KMP3, KMP4, KMP6	 Flat cables KASI	 Addressing cables KASI-ADR
Electrical connection	44-pin, Socket, Sub-D			
Electrical connection, connection type	Socket, Cable	Socket, Cable		Socket
Electrical connection, cable outlet	Straight, Angled	Straight, Angled		Straight, Angled
Electrical connection, design	Rectangular	Rectangular		Rectangular, Round
Electrical connection, connection technology	Open end, Sub-D	Open end, Sub-D		AS-Interface, M12x1 A-coded as per EN 61076-2-101
Electrical connection, number of pins/wires	10, 25, 26, 27, 36, 37, 44	9, 10, 15, 18, 20, 25, 26		2, 4
Cable length	2.5 ... 10 m	1 ... 99 m	100 m	
Description	<ul style="list-style-type: none"> • For multi-pin plug connection Sub-D • Connecting line between valve terminal and controller • Variants in easy-to-clean design • With PVC or PUR cable • Pre-assembled at one end • Ambient temperature -5 ... +50 °C 	<ul style="list-style-type: none"> • For multi-pin plug connection Sub-D • Connecting line between valve terminal and controller • Pre-assembled • With PVC or PUR cable • Ambient temperature -40 ... +70 °C 	<ul style="list-style-type: none"> • For AS-Interface® • Reverse polarity protected • Contact using insulation displacement technology • No need to strip cable and wire insulation • Two different colors: yellow (preferred for the AS-Interface® network) and black (for auxiliary power supply) 	<ul style="list-style-type: none"> • For AS-Interface® • For any slaves such as individual valve interface, valve manifold with AS-Interface® connection • Reverse polarity protected
online: →	nebv	kmp	kasi	kasi-adr

Connecting cables >



Connecting cables for valve terminals

	 Connecting cables KV-M12	 Connecting cables KMPV-SUB	 Connecting cables VMPA-KMS1, VMPA-KMS2, VMPAL-KM, VMPAL-KMSK	 Connecting cables NEBU-G78W5-K
Electrical connection			Cable with plug	
Electrical connection, connection type	Socket, Plug	Socket, Cable	Socket, Cable	Socket, Cable
Electrical connection, cable outlet	Straight	Straight	Angled	Angled
Electrical connection, design	Round	Rectangular	Rectangular	Round
Electrical connection, connection technology	M12x1 A-coded as per EN 61076-2-101	Open end, Sub-D	Open end, Sub-D	G7/8 coded as per NFPA/T3.5.29 R1-2007, Open end
Electrical connection, number of pins/wires	5	15	10, 25	5
Cable length	1.5 ... 3.5 m	5 ... 10 m	2.5 ... 10 m	2 m
Description	<ul style="list-style-type: none"> • Plug socket with cable for diagnostic interface (to CPX terminal) • Pre-assembled at both ends • With PUR cable • Ambient temperature -25 ... +70 °C 	<ul style="list-style-type: none"> • For multi-pin plug connection Sub-D • Pre-assembled at one end • With PUR cable • Ambient temperature -20 ... +80 °C 	<ul style="list-style-type: none"> • For multi-pin plug connection Sub-D • Connecting cable between valve terminal MPA and controller • Variants suitable for energy chains • Pre-assembled at one end • With PVC or PUR cable • Ambient temperature -40 ... +80 °C 	<ul style="list-style-type: none"> • Connecting cables with 5-pin plug/socket M12x1 A-coded according to EN 61076-2-101 and conductor nominal cross-section 1 mm² (NEBU-M12G5-E-...-Q8N-...) • Shielded connecting cables with 8-pin angled socket M12x1 A-coded according to EN 61076-2-101 (NEBU-M12W8-K-...) • Connecting cable with power supply socket G7/8 coded according to NFPA/T3.5.29 R1-2007 (NEBU-G78W5-...)
online: →	kv-m12	kmpv	vmpa-kms	nebu

Product overview



Connecting cables >

Connecting cables for sensors

	 Connecting cables NEBA	 Connecting cables NEBS	 Connecting cables NEBU-G78W5-K
Electrical connection, connection type	Socket, Cable, Plug	Socket, Cable, Plug	Socket, Cable
Electrical connection, cable outlet	Straight, straight, angled, Angled	Straight	Angled
Electrical connection, design	Round	Rectangular, Round	Round
Electrical connection, connection technology	M12x1 A-coded as per EN 61076-2-101, M8x1 A-coded as per EN 61076-2-104, Open end, Diameter 8 mm, A-coded according to EN 61076-2-104	Connection diagram L1J, M12x1 A-coded as per EN 61076-2-101, Open end	G7/8 coded as per NFPA/T3.5.29 R1-2007, Open end
Electrical connection, number of pins/wires	3, 4, 5	4, 5	5
Cable length	0.3 ... 30 m	0.5 ... 15 m	2 m
Description	<ul style="list-style-type: none"> • Powerful universally applicable connecting cables • Suitable for harsh environments and applications in constant motion or vibration • Meets IEC 61010-1 and IEC 61010-2-202 safety requirements for electrical equipment for measurement, control and laboratory use • High IP65, IP68, IP69k degree of protection • Resistant to abrasion and low adhesion • Suitable for use with energy chain and robot lines • Flame-retardant and self-extinguishing • Recommended for production systems for the manufacture of Li-ion batteries (F1A) 	<ul style="list-style-type: none"> • For connection with rectangular design L1, pitch 5.8 mm • For thread M12x1 A-coded according to EN 61076-2-101 • For thread M16x0.75 • Connecting cable for pressure sensor SPAN • Degree of protection to IP40, IP65, IP67, IP69K, in assembled state • With PVC or PUR cable • Ambient temperature -40 ... +70 °C 	<ul style="list-style-type: none"> • Connecting cables with 5-pin plug/socket M12x1 A-coded according to EN 61076-2-101 and conductor nominal cross-section 1 mm² (NEBU-M12G5-E-...-Q8N-...) • Shielded connecting cables with 8-pin angled socket M12x1 A-coded according to EN 61076-2-101 (NEBU-M12W8-K-...) • Connecting cable with power supply socket G7/8 coded according to NFPA/T3.5.29 R1-2007 (NEBU-G78W5-...)
online: →	neba	nebs	nebu

Plugs >



Universal plug connectors

	 Distributors NEDY	 Connecting cables NEBC
Electrical connection 1, design	Round	Rectangular, Round
Electrical connection 1, connection type	Cable, Plug	Socket, Hybrid plug, Cable, Plug, Plug and socket strip
Electrical connection 1, number of pins/wires	3, 4	3, 4, 5, 8, 9, 20, 25
Electrical connection 1, connection technology	M12x1 A-coded as per EN 61076-2-101, M8x1 A-coded as per EN 61076-2-104, Open end	Plug pattern P1, Connection diagram form A as per EN 175301-803, M12x1 A-coded as per EN 61076-2-101, M12x1, with Festo-specific coding, M12x1, D-coded as per EN 61076-2-101, M8x1 A-coded as per EN 61076-2-104, M8x1, D-coded as per EN 61076-2-114, RJ45, RJ45 as per IEC 60603-7-3, RJ45 and socket strip, 12 pins, 2 rows, Sub-D, USB 2.0 type B, Open end
Electrical connection 2, design	Rectangular, Round	Rectangular, Round
Electrical connection 2, connection type	2x socket, 2x cables	Socket, Hybrid plug, Cable, Plug
Electrical connection 2, number of pins/wires	2, 3, 4, 5	4, 5, 8, 9, 17, 25, 26
Electrical connection 2, connection technology	Connection diagram ZB, self-tapping screw, Connection diagram ZC, self-tapping screw, Connection diagram ZC, metric screw, Connection diagram H, Connection diagram form A as per EN 175301-803, Connection diagram form B as per EN 175301-803, Connection diagram form B as per industrial standard, 11 mm, Connection diagram type C as per EN 175301-803, Connection diagram form C as per industrial standard, 9.4 mm, M12x1 A-coded as per EN 61076-2-101, M8x1 A-coded as per EN 61076-2-104, Open end	M12x1 A-coded as per EN 61076-2-101, M12x1, with Festo-specific coding, M12x1, D-coded as per EN 61076-2-101, M8x1, D-coded as per EN 61076-2-114, M9x0.5, RJ45, RJ45 as per IEC 60603-7-3, Sub-D, USB 2.0, type A, Open end
Degree of protection	IP65, IP67, IP68, IP69K	IP20, IP40, IP65, IP66, IP67, IP69K, In mounted state
Connection cross section		0.25 mm ²
Description	<ul style="list-style-type: none"> • Collection of signals between field devices (sensors) and double-assigned controller inputs • Distribution of signals between double-assigned controller outputs and field devices (actuators, e.g. pneumatic valves) 	<ul style="list-style-type: none"> • Variants in easy-to-clean design • Variants that are default, with shielding or as a hybrid cable • Variants suitable for energy chains • Variants with EtherNet, CANopen, I-Port or RS232
online: →	nedy	nebc

Product overview

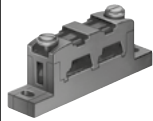

Plugs >

Universal plug connectors

	 Plugs NECU, NECU-HX	 Plug sockets with cable NEFU	 Cable distributors ASI-KVT
Electrical connection	3-pin, 4-pin, 7-pin, 8-pin, A-coded, Spring-loaded terminal, Screw terminal, Straight plug/insulation displacement connector, Plug, straight, Rectangular design, M8x1, M12x1		
Electrical connection 1	Socket, Sub-D, 9-pin, Straight socket, 7/8", 4-pin, Straight socket, 7/8", 5-pin, Straight socket, M12x1, 5-pin, B-coded, shieldable, Straight plug, M12x1, 4-pin, D-coded, shieldable, Straight plug, M12x1, 5-pin, B-coded, shieldable, Sub-D plug, 9-pin	Straight socket, M12x1, 4-pin, D-coded	
Electrical connection 2	IDC terminal, Screw terminal, Screw terminal, can be shielded	Straight socket, M12x1, 4-pin, D-coded, Angled socket, RJ45, 4-pin	
Electrical connection 3			
DC operating voltage range	0 ... 250 V	0 ... 30 V	≤75 V
Operating voltage range AC	0 ... 250 V		≤60 V
Degree of protection	IP20, IP40, IP65, IP67	IP20, IP65, IP67	IP65
Connection cross section	0.1 ... 2.5 mm ²		1.5 mm ²
Description	<ul style="list-style-type: none"> • Power supply socket for fieldbus connection • NECU-HX: reconnectable M8 and M12 round plug connectors with Harax® quick connection technology for low-voltage applications • Plug and socket for power supply • Can be assembled with any cable lengths 	<ul style="list-style-type: none"> • Cable socket for branching the AS-Interface® network at any required point • Reconnecting AS-Interface® flat cable to 5-pin M12 socket • Reverse polarity protected 	<ul style="list-style-type: none"> • Flat cable distributor for branching or for reconnecting AS-Interface® flat cables • Reverse polarity protected
online: →	necu	nefu	asi-kvt

Plugs >



Universal plug connectors

	 Plug sockets with cable ASI-SD	 Multi-pin plug distributors NEDU	 Push-in T-connectors NEDU
Electrical connection	2-pin, 4-pin, Socket, straight, Screw terminal		4-pin/4-pin/4-pin, A-coded/A-coded/A-coded, Socket/socket/plug, M12x1/M12x1/M12x1
Electrical connection 1		Straight socket, M8, 3-pin	Straight socket, M12x1, 5-pin, A-coded
Electrical connection 2		Straight plug, M12x1, 8-pin	Straight socket, M12, 5-pin, A-coded, Straight plug, M12x1, 2-pin, A-coded
Electrical connection 3			Straight plug, M12, 5-pin, A-coded, Straight plug, M12, 3-pin, A-coded
DC operating voltage range	≤75 V	10 ... 30 V	0 ... 30 V
Operating voltage range AC	≤125 V		
Degree of protection	IP65, IP67	IP68	IP65, IP67
Connection cross section	0.75 ... 1.5 mm ²		
Description	<ul style="list-style-type: none"> • For AS-Interface® • Flat-cable socket for connecting AS-Interface® stations to the AS-Interface® bus system • M12 connection • Reverse polarity protected • Detachable connection 	<ul style="list-style-type: none"> • Particularly compact • LED switching status indication 	<ul style="list-style-type: none"> • For fieldbus connection • Branch line for connecting and disconnecting fieldbus components
online: →	asi-sd	nedu	nedu

Product overview





Plugs >

Plug connectors for control systems

	 Plug NOCC	 Plugs NECC	 Plug, adapter, manifold block NEFC
Optical port 1, connection technology	SC-RJ as per IEC 61754-24		
Optical port 1, number of pins/wires	2		
Optical port 2, connection technology	Lock nut		
Electrical connection		9-pin/9-pin, Plug, Sub-D/screw terminal	5-pin, Plug, M12x1
Electrical connection, connection type		Socket, Plug	Socket, Plug
Electrical connection, design		Rectangular	Round
Electrical connection, connection technology		Spring-loaded terminal, Connection diagram L8, Insulation displacement connector, RJ45	M12x1 A-coded as per EN 61076-2-101
Electrical connection, number of pins/wires		5, 8	5, 8
Degree of protection	IP65, IP67	IP20, IP40, IP65, IP67	IP20, IP65, IP67
Description	<ul style="list-style-type: none"> • Push-pull plug for fiber optic applications • For Ethernet interface with PROFINET protocol • Protection against unintentional removal 	<ul style="list-style-type: none"> • Encoder plug connector for motor controller • For controllers • 2-pin, 4-pin, 6-pin, 8-pin, 11-pin, 18-pin 	<ul style="list-style-type: none"> • Adapter M12, 5-pin to mini USB socket with controller software for CPX terminal • Adapter for ERMS rotary drive unit which forms a connection between the motor and IO-Link Master • Plug and manifold block for motor controller CMMO-ST to form a connection from the I/O interface to the controller
online: →	nocc	necc	nefc

Plugs >

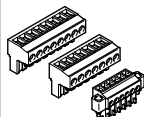
Plug connectors for control systems

	 Plugs FBS-SUB-9-WS	 Plugs PS1-SAC	 Assortments of plugs NEKM	 Plug socket NEFF
Electrical connection		10-pin/30-pin, Socket/terminal strip		
Degree of protection	IP20			IP40
Connection cross section	1 mm ²	0.08 ... 0.75 mm ²		
Description	<ul style="list-style-type: none"> • Plug connector for bus connection CAN bus and PROFIBUS • Cable connection 2x horizontal or 2x vertical • Printed circuit terminal block with screw connector 	<ul style="list-style-type: none"> • For power supply • Cable connection using clamping technology • Individually or as a set 	<ul style="list-style-type: none"> • For motor controllers CMMS-ST, CMM-AS • For servo drive 	<ul style="list-style-type: none"> • For operation of an interlock-capable valve manifold interface in pure I-Port mode
online: →	fbs-sub-9-ws	ps1	nekm	neff

Plugs >





Plug connectors for motors

	 <p>Adapters NEFM</p>
Electrical connection 1, connection type	Socket, Plug
Electrical connection, design	Rectangular
Electrical connection, connection technology	Connection diagram RE, RJ45, Sub-D
Electrical connection, number of pins/wires	6, 8, 9
Degree of protection	IP20
Description	<ul style="list-style-type: none"> • Pre-assembled • Adapter for encoder cable • With PVC cable • Ambient temperature -40 ... +80 °C
online: →	nefm

Product overview





Plugs >

Plug connectors for valves

	 Plug sockets MSSD	 Electrical plug-in base, adapter NEFV	 Illuminating seals MC-LD, ME-LD, MEB-LD, MF-LD, MV-LD	 Indicator inserts MCL, MFL, MFLZ
Electrical connection	3-pin, Socket, Socket, angled, Form A, Form B, Form C, as per DIN EN 175301-803, as per DIN EN 61984, Rectangular design, Rectangular design MSC, Rectangular design MSEB, Rectangular design MSF, Rectangular design MSN1, Rectangular design MSN2, Rectangular design MSV		Form A, Form B, Form C, as per DIN EN 175301-803, Rectangular design MSC, Rectangular design MSE, Rectangular design MSEB, Rectangular design MSF, Rectangular design MSV	Form A, Form B, Plug, as per DIN EN 175301-803, As per industrial standard (11 mm)
Electrical connection, connection type	Socket, Cable	Socket, 4x plugs		
Electrical connection, design	Rectangular	Round		
Electrical connection, connection technology	Connection diagram form A as per EN 175301-803, Connection diagram form B as per industrial standard, 11 mm, Connection diagram type C as per EN 175301-803, Screw terminal	M12x1 A-coded as per EN 61076-2-101		
Electrical connection, number of pins/wires	3	8		
Connection cross section	0.25 ... 1.5 mm ²			
Degree of protection	IP50, IP65, IP67, as per IEC 60529	IP65, IP67	IP65	IP65, as per IEC 60529
Description	<ul style="list-style-type: none"> • For pneumatic valves with F, D, N1, V, E, EB, N2, Y, Z, ZB, ZC, MD-2 and MH-2 solenoid coils • For connecting individual valves • With optional LED display 	<ul style="list-style-type: none"> • Adapter for connecting the piezo valves to the electronics module VAVE-P12 	<ul style="list-style-type: none"> • The seal is illuminated yellow when the power is switched on • For mounting between the solenoid coil and connector socket or plug • For F, D, N1, V, E, and EB solenoid coils 	<ul style="list-style-type: none"> • Variant with integrated protective circuit • For mounting between the solenoid coil and connector socket or plug • With yellow LED indicator
online: →	mssd	nefv	mc-ld	mcl





Plugs >

Plug connectors for valves

	 Time delay inserts MFZ	 Soldering bases PCBC	 Multi-pin plug sockets NECA	 Multi-pin plug distributor MPV-E/A
Electrical connection		2-pin		
Connection cross section			0.34 ... 1 mm ²	
Degree of protection	IP64	IP40	IP65, as per IEC 60529	IP65, In mounted state, as per IEC 60529
Description	<ul style="list-style-type: none"> Electronic timer with adjustable time delay of between 0 ... 10 s For mounting between the solenoid coil and connector socket or plug 	<ul style="list-style-type: none"> For mounting miniature valves MHA1 and MHP1 on a PCB with plug connection underneath (-PI) 	<ul style="list-style-type: none"> For soft-start/quick exhaust valves MS6-SV, MS series Electrical connection via 9-pin Sub-D, 9-pin screw terminal 	<ul style="list-style-type: none"> Mounting: H-rail mounting or via through-holes LED switching status indication
online: →	mfz	pcbc	neca	mpv

Plugs >



Plug connectors for valve terminals

	 Cable plug connectors NECL	 Plug sockets FBSD-GD, FBSD-WD	 Plug sockets NTSD-GD, NTSD-WD	 T adapter FB-TA
Electrical connection		4-pin, 5-pin/5-pin, Straight socket/screw terminal, Angled socket/screw terminal, Form A, M12x1	4-pin, 5-pin, Socket, straight, Socket, angled, Screw terminal, Straight plug/screw terminal	5-pin, M12x1/M12x1, Plugs/sockets
Fieldbus interface				
Degree of protection	IP65, IP67	IP20, IP67	IP67	IP67
Connection cross section		0.2 ... 2.5 mm ²	0.75 ... 2.5 mm ²	
Description	<ul style="list-style-type: none"> Power supply connection socket, power supply plug Straight or angled design For thread M12x1 L-coded according to EN 61076-2-111 For cable diameter 8 ... 13 mm 	<ul style="list-style-type: none"> For fieldbus connection Straight or angled design 	<ul style="list-style-type: none"> Straight or angled design For power supply 	<ul style="list-style-type: none"> Branch line for connecting and disconnecting fieldbus components For fieldbus connection with thread M12x1 A-coded according to EN 61076-2-101 Cable length 150 mm
online: →	necl	fbs	ntsd	fb-ta

Product overview



Plugs >

Plug connectors for valve terminals

	 Bus connections FBA-1, FBA-2	 Plugs FBS-SUB, FBS-SCRJ, FBS-M12	 Plugs FBS-RJ45
Electrical connection	9-pin/5-pin, Straight socket/straight plug, Straight socket/plug and socket, Sub-D / -, Sub-D / M12x1		
Fieldbus interface	Socket and plug, M12x1, 5-pin, B-coded	1x 5 spring-loaded terminals, 1x 9 spring-loaded terminals, 2x 2 spring-loaded terminals, 2x 4 spring-loaded terminals, 2x 5 spring-loaded terminals	
Degree of protection	IP40, IP65, as per IEC 60529	IP65, IP67, In mounted state, as per IEC 60529	IP65, IP67, as per IEC 60529
Connection cross section			
Description	<ul style="list-style-type: none"> • 9-pin Sub-D plug on M12 or screw terminal for CANopen and DeviceNet® • 9-pin Sub-D socket on M12 for PROFIBUS and CC-Link 	<ul style="list-style-type: none"> • Field connector with 9-pin Sub-D connection • Variants for different fieldbus systems • Position of DIL switches can be read externally • Easy assembly 	<ul style="list-style-type: none"> • Push-pull plug for RJ45 applications • For Ethernet interface with PROFINET protocol • Detachable connection
online: →	fba	fbs-sub	fbs-rj



Plugs >

Plug connectors for valve terminals

	 Bus connections FBSD-KL	 Cover caps ISK	 Plug sockets, plug connectors SD-SUB
Electrical connection	5-pin/5-pin, Angled socket/screw terminal		25-pin, Plug, Sub-D
Fieldbus interface			
Degree of protection	IP20	IP65, IP67	IP65
Connection cross section	0.2 ... 2.5 mm ²		
Description	<ul style="list-style-type: none"> • 5-pin angled socket, 5-pin screw terminal 	<ul style="list-style-type: none"> • For sealing unused connections/openings • Thread M8, M12 	<ul style="list-style-type: none"> • Plug socket for multi-pin plug connection • Plug for inputs/outputs • Can be assembled with any cable lengths
online: →	fbsd-kl	isk	sd-sub

Plugs >

Plug connectors for sensors

	 Angled plug sockets PEV...-WD	 Plug sockets SD-4-WD
Electrical connection	4-pin, Socket, angled	
Degree of protection	IP65	IP65, as per IEC 60529
Description	<ul style="list-style-type: none"> • For pressure switch PEV • 15 ... 30, 180 V DC, 230 V AC • With optional LED display • Angled design 	<ul style="list-style-type: none"> • For swivel module DSMI • Angled design
online: →	pev*wd	sd-4-wd

Product overview



Product overview

Software tools

Media resistance calculation



Which Festo tubing is resistant to benzene? Can elastomers withstand contact with glycol? Which stainless steel can be used in acetic acid?

These and many other questions about media resistance are answered here. You can search for chemical reactions from A to Z.

You can filter the media either by name or chemical formula and/or select the material in question.

This tool can be found at www.festo.com/x/media-resistance

Configurator for tubing



Design a product with numerous characteristics reliably and quickly with the help of the configurator.

Select all the required product characteristics step-by-step.

The use of logic checks ensures that only correct configurations are available for selection.

You can find the configurator for your desired product

- at www.festo.com/catalogue/schlaeuche
- Choose your desired product
- Click the blue „Configure product“ button

Festo Design Tool 3D



The Festo Design Tool 3D is a 3D product configurator for generating specific CAD product combinations from Festo.

The configurator makes your search for the right accessory quicker, easier, and more reliable





You can then order the module that has been created as a single order item – either completely pre-assembled or as individual parts in a single box.

This considerably reduces your bill of materials, and downstream processes such as product ordering, order picking and assembly are significantly simplified.

This tool can be found at www.festo.com/fdt-3D





Pneumatic tubing >

O.D. pneumatic tubing

	 Plastic tubing PUN-H, PUN-H-DUO	 Plastic tubing PUN-H-SF	 Plastic tubing PUN-H, NPT	 Plastic tubing PUN-H-F
Outside diameter	2 ... 16 mm	4 ... 25 mm		4 ... 16 mm
Inside diameter	1.2 ... 11 mm	2.3 ... 15.3 mm		2.6 ... 11 mm
Temperature-dependent operating pressure [MPa]	-0.095 ... 1 MPa	-0.095 ... 1.3 MPa		-0.095 ... 1 MPa
Temperature-dependent operating pressure	-0.95 ... 10 bar	-0.95 ... 13 bar	-0.993 ... 9.997 bar	-0.95 ... 10 bar
Temperature-dependent operating pressure [psi]	-13.775 ... 145 psi	-13.775 ... 188.5 psi		-13.775 ... 145 psi
Ambient temperature	-35 ... 60°C	-35 ... 80°C	-35 ... 63°C	-35 ... 60°C
Description	<ul style="list-style-type: none"> • Polyurethane • High resistance to microbes and hydrolysis • Suitable for energy-chains • Clean room-compatible combination with NPKA screw connection • Also available as DUO plastic tubing • Operating media compressed air, vacuum, water. Water according to manufacturer's declaration, see www.festo.com/certificates/PUN_H 	<ul style="list-style-type: none"> • Polyurethane • High buckling strength and robustness due to increased wall thickness • Maximum flexibility despite increased wall thickness • High resistance to microbes and hydrolysis • Suitable for energy-chains • Operating media: compressed air, vacuum, water 	<ul style="list-style-type: none"> • Polyurethane • High resistance to microbes and hydrolysis • Suitable for energy-chains • Operating media: compressed air, vacuum, water 	<ul style="list-style-type: none"> • Polyurethane • High resistance to microbes and hydrolysis • For food safety certificates, see www.festo.com/certificates/PUN_H_F • Operating media: compressed air, vacuum, water
online: →	pun-h	pun-h-sf	pun-h	pun-h-f

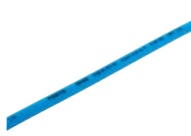
Pneumatic tubing >





O.D. pneumatic tubing

	 Plastic tubings PUN, PUN-DUO	 Plastic tubing PTFEN	 Plastic tubing PTFEN, NPT	 Plastic tubing PUN-CM
Outside diameter	3 ... 16 mm	4 ... 16 mm		4 ... 12 mm
Inside diameter	2.1 ... 11 mm	2.9 ... 11 mm	2.9 ... 8.5 mm	2.5 ... 8 mm
Temperature-dependent operating pressure [MPa]	-0.095 ... 1 MPa	-0.095 ... 1.5 MPa	-0.095 ... 1.2 MPa	-0.095 ... 1 MPa
Temperature-dependent operating pressure	-0.95 ... 10 bar	-0.95 ... 15 bar	-0.95 ... 12 bar	-0.95 ... 10 bar
Temperature-dependent operating pressure [psi]	-13.775 ... 145 psi	-13.775 ... 217.5 psi	-13.775 ... 174 psi	-13.775 ... 145 psi
Ambient temperature	-35 ... 60°C	-20 ... 150°C	-20 ... 150°C	-35 ... 60°C
Description	<ul style="list-style-type: none"> • Polyurethane • High resistance to stress cracks • Suitable for energy-chains • Also available as DUO plastic tubing • Operating medium compressed air, vacuum 	<ul style="list-style-type: none"> • Polytetrafluoroethylene • Food grade see www.festo.com/certificates/PTFEN • High resistance to chemicals • High temperature resistance • Operating medium compressed air, vacuum 	<ul style="list-style-type: none"> • Polytetrafluoroethylene • Food grade see www.festo.com/certificates/PTFEN • High resistance to chemicals • High temperature resistance • Operating medium compressed air, vacuum 	<ul style="list-style-type: none"> • Polyurethane • Plastic tubing, antistatic, electrically conductive • Suitable for energy-chains • Operating medium compressed air, vacuum
online: →	pun	ptfen	ptfen	pun-cm

Product overview





Pneumatic tubing >

O.D. pneumatic tubing

	 Plastic tubing PUN-V0	 Plastic tubings PEN	 Plastic tubing PEN, NPT	 Plastic tubings PAN
Outside diameter	4 ... 16 mm	4 ... 16 mm		4 ... 16 mm
Inside diameter	2 ... 11.8 mm	2.7 ... 10.8 mm		2.9 ... 12 mm
Temperature-dependent operating pressure [MPa]	-0.095 ... 3 MPa	-0.095 ... 1 MPa	-0.095 ... 1 MPa	-0.095 ... 1.9 MPa
Temperature-dependent operating pressure	-0.95 ... 30 bar	-0.95 ... 10 bar	-0.95 ... 10 bar	-0.95 ... 19 bar
Temperature-dependent operating pressure [psi]	-13.775 ... 435 psi	-13.775 ... 145 psi	-13.775 ... 145 psi	-13.775 ... 275.5 psi
Ambient temperature	-35 ... 60°C	-30 ... 60°C	-30 ... 60°C	-30 ... 80°C
Description	<ul style="list-style-type: none"> • Polyurethane • Flame retardant to UL 94 V0 ... V2 • For use in the immediate vicinity of welding applications • High resistance to microbes and hydrolysis • Suitable for energy-chains • Operating media: compressed air, vacuum, water 	<ul style="list-style-type: none"> • Polyethylene • High resistance to chemicals and very high resistance to hydrolysis • Resistant to most cleaning agents and lubricants • Suitable for energy-chains • Operating media compressed air, vacuum, water. Water according to manufacturer's declaration, see www.festo.com/certificates/PEN_S 	<ul style="list-style-type: none"> • Polyethylene • High resistance to chemicals and very high resistance to hydrolysis • Resistant to most cleaning agents and lubricants • Suitable for energy-chains • Operating media compressed air, vacuum, water. Water according to manufacturer's declaration, see www.festo.com/certificates/PEN_S 	<ul style="list-style-type: none"> • Polyamide • High thermal and mechanical load capacities • Highly resistant to microbes • Operating medium compressed air, vacuum
online: →	pun-v0	pen	pen	pan

Pneumatic tubing >





O.D. pneumatic tubing

	 Plastic tubing PAN-MF	 Heavy-duty tubing PAN-R	 Plastic tubing PAN-V0	 Customer-specific tubings PAN, PEN, PLN, PUN
Outside diameter	4 ... 16 mm	4 ... 28 mm	6 ... 14 mm	3 ... 16 mm
Inside diameter	2.5 ... 12 mm	2.5 ... 23 mm	2.5 ... 9 mm	2 ... 12 mm
Temperature-dependent operating pressure [MPa]	-0.095 ... 3.1 MPa	-0.095 ... 3.5 MPa	-0.095 ... 1.2 MPa	
Temperature-dependent operating pressure	-0.95 ... 31 bar	-0.95 ... 35 bar	-0.95 ... 12 bar	-0.95 ... 35 bar
Temperature-dependent operating pressure [psi]	-13.775 ... 449.5 psi	-13.775 ... 507.5 psi	-13.775 ... 174 psi	
Ambient temperature	-60 ... 100°C	-30 ... 80°C	-30 ... 90°C	-60 ... 100°C
Description	<ul style="list-style-type: none"> • Polyamide • High thermal and mechanical load capacities • Meets the requirements to DIN 73378 "Polyamide piping for use in motor vehicles" • Operating media: compressed air, mineral oil 	<ul style="list-style-type: none"> • Polyamide • For applications with high pressure ranges • Highly resistant to microbes • Operating medium: compressed air, vacuum 	<ul style="list-style-type: none"> • PVC, polyamide • Flame retardant to UL 94 V0 • High resistance to microbes and UV radiation • Double-sheath tubing • Operating medium: compressed air, vacuum, water, mineral oil • Resistant to welding spatter 	<ul style="list-style-type: none"> • Individual lengths: delivered in units of 25, 50, 100, 200 ... 500 m • Minimum order quantity: depending on diameter from 1500m/3000m (or less depending on type) • Customized design: specific printing possible • Easy to recognize and handle: individual color selection • Choose from 9 basic colors; further colors available on request • Select, size and order easily, quickly and reliably via the configurator
online: →	pan-mf	pan-r	pan-v0	pan

Product overview

Pneumatic tubing >

O.D. pneumatic tubing

	 Customer-specific tubing PEN-U, PLN-U, PUN-U, NPT	 Plastic tubings PLN	 Plastic tubing PLN, NPT	 Plastic tubing PFAN
Outside diameter		4 ... 16 mm		3 ... 12 mm
Inside diameter		2.9 ... 12 mm		2.3 ... 8.4 mm
Temperature-dependent operating pressure [MPa]	-0.095 ... 1.4 MPa	-0.095 ... 1.4 MPa	-0.095 ... 1.4 MPa	-0.095 ... 1.6 MPa
Temperature-dependent operating pressure	-0.95 ... 14 bar	-0.95 ... 14 bar	-0.95 ... 14 bar	-0.95 ... 16 bar
Temperature-dependent operating pressure [psi]	-13.775 ... 203 psi	-13.775 ... 203 psi	-13.775 ... 203 psi	-13.775 ... 232 psi
Ambient temperature	-35 ... 81°C	-30 ... 80°C	-30 ... 80°C	-20 ... 150°C
Description	<ul style="list-style-type: none"> Individual lengths: delivered in units of 150, 500, 1000, 1500 ft Minimum acceptance: from 4500 ft, depending on outside diameter of tubing Customized design: specific printing possible Easy to recognize and handle: individual color selection Choose from 9 basic colors; further colors available on request Select, size and order easily, quickly and reliably via the configurator 	<ul style="list-style-type: none"> Polyethylene High resistance to chemicals, microbes, and hydrolysis Food grade see www.festo.com/certificates/PLN Resistant to most cleaning agents and lubricants Operating media compressed air, vacuum, water. Water according to manufacturer's declaration, see www.festo.com/certificates/PLN 	<ul style="list-style-type: none"> Polyethylene High resistance to chemicals, microbes, and hydrolysis Food grade see www.festo.com/certificates/PLN Resistant to most cleaning agents and lubricants Operating media: compressed air, vacuum, water 	<ul style="list-style-type: none"> Perfluoroalkoxy alkane Pneumatic tubing with resistance to high temperatures and chemicals Food grade see www.festo.com/certificates/PFAN High resistance to chemicals, microbes, UV radiation, hydrolysis, and stress cracks Operating media compressed air, vacuum, water. Water according to manufacturer's declaration, see www.festo.com/certificates/PFAN
online: →	pen-u	pln	pln	pfan



Pneumatic tubing >

I.D. tubing

	 Plastic tubing PU
Outside diameter	11.6 ... 17.6 mm
Inside diameter	9 ... 13 mm
Operating pressure for entire temperature range	-0.95 ... 10 bar
Ambient temperature	-35 ... 60°C
Description	<ul style="list-style-type: none"> Polyurethane with reinforcing fabric High resistance to abrasion and kinks Operating media: compressed air, vacuum (PU-13)
online: →	pu

Pneumatic tubing >



Spiral tubing

	 Spiral plastic tubing PUN-S, PUN-S-DUO	 Spiral plastic tubing PUN-SG	 Spiral plastic tubing PPS
Outside diameter	4 ... 12 mm	10 ... 12.4 mm	6.3 ... 7.8 mm
Inside diameter	2.6 ... 8 mm	6 ... 8 mm	4.7 ... 6.2 mm
working length	0.5 ... 6 m	2.4 ... 6 m	7.5 ... 15 m
Temperature-dependent operating pressure	-0.95 ... 10 bar	-0.95 ... 15 bar	-0.95 ... 21.2 bar
Ambient temperature	-35 ... 60°C	-40 ... 60°C	-30 ... 80°C
Description	<ul style="list-style-type: none"> • Polyurethane • Also available as DUO plastic tubing • Operating medium compressed air, vacuum • High resistance to UV radiation and stress cracks 	<ul style="list-style-type: none"> • Polyurethane, nickel-plated brass, polyacetal • Pre-assembled with captive rotatable fittings • High resistance to microbes and hydrolysis • Operating medium compressed air, vacuum 	<ul style="list-style-type: none"> • Polyamide, brass, galvanized steel • Pre-assembled with 2 rotatable connectors and captive sealing rings OL • Highly resistant to microbes • Operating medium compressed air, vacuum
online: →	pun-s	pun-sg	pps

Product overview



Pneumatic fittings >

Pneumatic push-in fittings

	 Push-in fittings/joints, mini series QSM, NPT	 Push-in fittings/connectors, standard series QS, QSM	 Push-in fittings, standard series QS, NPT
Pneumatic connection 1	Push-in sleeve Ø 1/8", Push-in sleeve Ø 5/32", Male thread M3, M5, M7	External thread M8x1.25, push-in sleeve Ø 2 mm, Push-in sleeve Ø 3 mm, Push-in sleeve Ø 4 mm, Push-in sleeve Ø 6 mm, Push-in sleeve Ø 8 mm, Push-in sleeve Ø 10 mm, Push-in sleeve Ø 12 mm, Push-in sleeve Ø 16 mm, Female thread G1/2, G1/4, G1/8, G3/8, M3, M5, For tubing O.D. 10 mm, 12 mm, 16 mm, 2 mm, 3 mm, 4 mm, 6 mm, 8 mm, Male thread G1/2, G1/4, G1/8, G3/4, G3/8, M3, M5, M6, M6x0.75, M7, M8x0.75, R1/2, R1/4, R1/8, R3/8	external thread 1/8 NPT, external thread 1/4 NPT, external thread 3/8 NPT, external thread 1/2 NPT, Internal thread 1/8 NPT, Internal thread 1/4 NPT, Internal thread 3/8 NPT, internal thread 1/2 NPT, Push-in sleeve Ø 3/16", Push-in sleeve Ø 5/32", Push-in sleeve Ø 1/4", Push-in sleeve Ø 5/16", Push-in sleeve Ø 3/8", Push-in sleeve Ø 1/2", Push-in sleeve Ø 5/8", For tubing O.D. 1/2 in, 1/4 in, 1/8 in, 3/16 in, 3/8 in, 5/16 in, 5/32 in, 5/8 in, Male thread M5, R1/2, R1/4, R1/8, R3/8
Pneumatic connection 2	For tubing O.D. 1/4 in, 1/8 in, 3/16 in, 5/32 in	Push-in sleeve Ø 4 mm, Push-in sleeve Ø 6 mm, Push-in sleeve Ø 8 mm, Push-in sleeve Ø 10 mm, Push-in sleeve Ø 12 mm, Push-in sleeve Ø 16 mm, Female thread G1/2, G1/4, G1/8, G3/8, For tubing O.D. 10 mm, 12 mm, 16 mm, 2 mm, 22 mm, 3 mm, 4 mm, 6 mm, 8 mm	Female thread 1/8 NPT, Internal thread 1/4 NPT, Female thread 3/8 NPT, Push-in sleeve Ø 5/32", Push-in sleeve Ø 3/16", Push-in sleeve Ø 1/4", Push-in sleeve Ø 5/16", Push-in sleeve Ø 3/8", Push-in sleeve Ø 1/2", For tubing O.D. 1/2 in, 1/4 in, 3/16 in, 3/8 in, 5/16 in, 5/32 in, 5/8 in
Design	L-shape, Straight design	45° angle, 45° angle, long, Blanking plug, L-shape, L-shape, dual, parallel, L-shape, long, L-shape, additional connection internal thread lengthwise, L-shape, additional push-in connector, lengthwise, Bulkhead, T-shape, X-shape, Y-shape, Straight design, straight design, round releasing ring	Blanking plug, L-shape, L-shape, dual, parallel, L-shape, long, L-shape, additional connection internal thread lengthwise, Bulkhead, Straight design
Temperature-dependent operating pressure		-0.95 ... 14 bar	
Operating pressure for entire temperature range	-0.95 ... 10 bar	-0.95 ... 14 bar	-0.95 ... 10 bar
Ambient temperature	-10 ... 60°C	-20 ... 80°C	-10 ... 60°C
Description	<ul style="list-style-type: none"> • Mini series • Compact for maximum component density in confined installation spaces • PBT or nickel-plated brass • Operating medium compressed air, vacuum • Straight design, L-shaped 	<ul style="list-style-type: none"> • Design: Standard and mini series • Wide range of variants: Wide selection for maximum flexibility in standard applications • Dimensions: small design for maximum packing density in the smallest installation space • Material: PBT and nickel-plated brass • Operating medium: Compressed air, vacuum, water (according to manufacturer declaration, see www.festo.com/certificates/QS) • Design/shape: straight shape, L/LL, T, X, Y-shape, push-in bulkhead connector etc. • Assembly/installation: External and internal hex and push-in connector for externally calibrated hoses 	<ul style="list-style-type: none"> • Standard series • Wide range of variants: large selection for maximum flexibility in standard applications • PBT or nickel-plated brass • Operating medium compressed air, vacuum • Straight design, L-shaped, T-shaped, bulkhead push-in fitting
online: →	qsm	qs	qs

Pneumatic fittings >



Pneumatic push-in fittings

	 Push-in fittings/connectors NPQH	 Push-in fittings/connectors NPQE-F1A	 Push-in fitting NPQO
Pneumatic connection 1	Push-in sleeve Ø 4 mm, Push-in sleeve Ø 6 mm, Push-in sleeve Ø 8 mm, Push-in sleeve Ø 10 mm, Push-in sleeve Ø 12 mm, Push-in sleeve Ø 14 mm, Female thread G1/4, G1/8, For tubing O.D. 10 mm, 12 mm, 14 mm, 4 mm, 6 mm, 8 mm, Male thread G1/2, G1/4, G1/8, G3/8, M5, M7	For tubing O.D. 10 mm, 12 mm, 4 mm, 6 mm, 8 mm, Male thread G1/4, G1/8, M3, M5, M7, R1/4, R1/8	External thread M5, External thread G1/8, External thread G1/4, External thread G3/8, for pneumatic tubing outside diameter 4 mm, For pneumatic tubing outside diameter 6 mm, for pneumatic tubing outside diameter 8 mm, for pneumatic tubing outside diameter 10 mm, for pneumatic tubing outside diameter 12 mm
Pneumatic connection 2	Push-in sleeve Ø 4 mm, Push-in sleeve Ø 6 mm, Push-in sleeve Ø 8 mm, Push-in sleeve Ø 10 mm, Push-in sleeve Ø 12 mm, Push-in sleeve Ø 14 mm, For tubing O.D. 10 mm, 12 mm, 14 mm, 4 mm, 6 mm, 8 mm	For tubing O.D. 10 mm, 12 mm, 4 mm, 6 mm, 8 mm	for pneumatic tubing outside diameter 4 mm, for pneumatic tubing outside diameter 6 mm, for pneumatic tubing outside diameter 8 mm, for pneumatic tubing outside diameter 10 mm, for pneumatic tubing outside diameter 12 mm
Design	Blanking plug, L-shape, L-shape, long, Bulkhead, T-shape, Plug screw, Y-shape, Straight design	L-shape, T-shape, Y-shape, Straight design	L-shape, T-shape, Straight design
Temperature-dependent operating pressure			-0.9 ... 16 bar
Operating pressure for entire temperature range	-0.95 ... 20 bar	-0.95 ... 8 bar	-0.9 ... 20 bar
Ambient temperature	0 ... 150°C	-5 ... 60°C	0 ... 120°C
Description	<ul style="list-style-type: none"> • Solid-metal brass, chemically nickel-plated • High corrosion and chemical resistance • Highly resistant to temperatures and pressure • Food grade see www.festo.com/certificates/NPQH • Operating media compressed air, vacuum, water. Water according to manufacturer's declaration, see www.festo.com/certificates/NPQH • Straight design, L-shaped, T-shaped, Y-shaped, push-in bulkhead connector 	<ul style="list-style-type: none"> • Economical push-in fittings for pneumatic applications • Recommended for production systems for the manufacture of Li-ion batteries (F1A) • Tapered thread in accordance with JIS B0203 and compatible with pressure-tight media as per DIN EN 10226 • Operating medium compressed air, vacuum • Straight shape, T-shape, L-shape, Y-shape 	<ul style="list-style-type: none"> • Oxygen compatibility (according to ISO 15001 and ASTM G93) • Biocompatibility (according to ISO 18562) • FDA-listed materials • Can be used with a variety of gases (O₂, CO₂, N₂O, NO, He, N₂, Xe, Ar) • Wide range from 4 mm to 12 mm in size • Push-in fittings and ports (straight, L-shaped, T-shaped)
online: →	npqh	npqe	npqo

Product overview



Pneumatic fittings >

Pneumatic push-in fittings

	 Push-in fittings/connectors NPQR	 Push-in fittings/connectors, metal, standard series NPQM	 Push-in fittings/connectors, resistant to media NPQP
Pneumatic connection 1	For tubing O.D. 10 mm, 12 mm, 14 mm, 16 mm, 4 mm, 6 mm, 8 mm, Male thread G1/2, G1/4, G1/8, G3/8, M5, M7	Push-in sleeve Ø 4 mm, Push-in sleeve Ø 6 mm, Push-in sleeve Ø 8 mm, Push-in sleeve Ø 10 mm, Push-in sleeve Ø 12 mm, Push-in sleeve Ø 14 mm, Female thread G1/4, G1/8, For tubing O.D. 10 mm, 12 mm, 14 mm, 4 mm, 6 mm, 8 mm, Male thread G1/2, G1/4, G1/8, G3/8, M5, M7, Push-in sleeve QS-10, QS-12, QS-8	Push-in sleeve Ø 4 mm, Push-in sleeve Ø 6 mm, Push-in sleeve Ø 8 mm, Push-in sleeve Ø 10 mm, Push-in sleeve Ø 12 mm, For tubing O.D. 10 mm, 12 mm, 4 mm, 6 mm, 8 mm, Male thread R1/2, R1/4, R1/8, R3/8
Pneumatic connection 2	For tubing O.D. 10 mm, 12 mm, 14 mm, 16 mm, 4 mm, 6 mm, 8 mm	For tubing O.D. 10 mm, 12 mm, 14 mm, 3 mm, 4 mm, 6 mm, 8 mm, Push-in sleeve QS-10, QS-12, QS-14, QS-4, QS-6, QS-8	For tubing O.D. 10 mm, 12 mm, 4 mm, 6 mm, 8 mm
Design	L-shape, Bulkhead, T-shape, Plug screw, Y-shape, Straight design	L-shape, L-shape, dual, F-outlet, Bulkhead, T-shape, Y-shape, Straight design	Blanking plug, L-shape, L-shape, additional push-in connector, lengthwise, Bulkhead, T-shape, Y-shape, Straight design
Temperature-dependent operating pressure			-0.95 ... 10 bar
Operating pressure for entire temperature range	-0.95 ... 16 bar	-0.95 ... 16 bar	-0.95 ... 4.5 bar
Ambient temperature	-20 ... 150°C	-20 ... 70°C	-20 ... 60°C
Description	<ul style="list-style-type: none"> • Very easy-to-clean thanks to chambered O-ring and fewer edges that accumulate dirt • Optimal price/performance ratio, ideal for applications from a single source • Maximum corrosion resistance (corrosion resistance class CRC 4 to Festo standard 940 070) and chemical resistance • High temperature resistance • Stainless steel • Operating media: compressed air, vacuum, (water) • Straight design, L-shaped, T-shaped, Y-shaped, push-in bulkhead connector 	<ul style="list-style-type: none"> • Solid-metal brass, nickel-plated • Attractively priced metal push-in fitting • Robust • Operating medium compressed air, vacuum • Straight design, L-shaped, T-shaped, Y-shaped, push-in bulkhead connector 	<ul style="list-style-type: none"> • Polypropylene • Low-cost alternative to stainless steel: resistant to most cleaning agents in combination with pneumatic tubing PLN • For use with extreme influence of media • Food grade see www.festo.com/certificates/NPQP • Operating medium compressed air, vacuum • Straight design, L-shaped, T-shaped, Y-shaped, push-in bulkhead connector
online: →	npqr	npqm	npqp

Pneumatic fittings >





Pneumatic push-in fittings

	 Push-in fittings/connectors CRQS, NPT	 Push-in fittings/connectors QB, NPT	 Push-in fittings/joints, mini series QBM, NPT
Pneumatic connection 1	Male thread 1/8 NPTF, Male thread 1/4 NPTF, Male thread 3/8 NPTF, Male thread 1/2 NPTF, Push-in sleeve Ø 1/4", Push-in sleeve Ø 5/16", Push-in sleeve Ø 3/8", For tubing O.D. 1/2 in, 1/4 in, 3/8 in, 5/16 in, 5/32 in	External thread 10-32 UNF-2A, external thread 1/8 NPT, external thread 1/4 NPT, external thread 3/8 NPT, external thread 1/2 NPT, Internal thread 10-32 UNF-2B, Internal thread 1/8 NPT, Internal thread 1/4 NPT, Internal thread 3/8 NPT, internal thread 1/2 NPT, Push-in sleeve Ø 1/8", Push-in sleeve Ø 3/16", Push-in sleeve Ø 5/32", Push-in sleeve Ø 1/4", Push-in sleeve Ø 5/16", Push-in sleeve Ø 3/8", Push-in sleeve Ø 1/2", For tubing O.D. 1/2 in, 1/4 in, 3/16 in, 3/8 in, 5/16 in, 5/32 in, Male thread M5, R1/2, R1/4, R1/8, R3/8	External thread 10-32 UNF-2A, external thread 1/8 NPT, external thread 1/4 NPT, Internal thread 10-32 UNF-2B, Push-in sleeve Ø 1/8", Push-in sleeve Ø 5/32", For tubing O.D. 1/4 in, 1/8 in, 3/16 in, 5/32 in, Male thread M5, R1/8
Pneumatic connection 2	For tubing O.D. 1/2 in, 1/4 in, 3/8 in, 5/16 in, 5/32 in	Push-in sleeve Ø 5/32", Push-in sleeve Ø 3/16", Push-in sleeve Ø 1/4", Push-in sleeve Ø 5/16", Push-in sleeve Ø 3/8", For tubing O.D. 1/2 in, 1/4 in, 1/8 in, 3/16 in, 3/8 in, 5/16 in, 5/32 in	For tubing O.D. 1/4 in, 1/8 in, 5/32 in
Design	L-shape, T-shape, Straight design	Blanking plug, L-shape, L-shape, long, L-shape, additional push-in connector, lengthwise, Bulkhead, T-shape, X-shape, Y-shape, Straight design	Blanking plug, L-shape, L-shape, long, L-shape, additional push-in connector, lengthwise, T-shape, Y-shape, Straight design
Temperature-dependent operating pressure			
Operating pressure for entire temperature range	-0.95 ... 14 bar	0.95 ... 10 bar	0.95 ... 10 bar
Ambient temperature	-20 ... 150°C	0 ... 60°C	0 ... 60°C
Description	<ul style="list-style-type: none"> • Maximum corrosion resistance (corrosion resistance class CRC 4 to Festo standard 940 070) and chemical resistance • Operating medium compressed air, vacuum • Stainless steel • Straight design, L-shaped, T-shaped 	<ul style="list-style-type: none"> • Standard series for pneumatic tubing with imperial dimensions • Pneumatic connection via R, NPT, UNF, metric thread or push-in sleeve • PBT and nickel-plated brass • Operating media compressed air (vacuum) • Straight design, L-shaped, T-shaped, X-shaped, Y-shaped, push-in bulkhead connector 	<ul style="list-style-type: none"> • Mini series for pneumatic tubing with imperial dimensions • Compact for maximum component density in confined installation spaces • Pneumatic connection via R, NPT, UNF, metric thread or push-in sleeve • PBT and nickel-plated brass • Operating media compressed air (vacuum) • Straight shape, T-shape, L-shape, Y-shape
online: →	crqs	qb	qbm

Product overview





Pneumatic fittings >

Pneumatics push-in fittings

				
	Push-in fittings, resistant to welding spatter QS-V0	Self-sealing push-in fittings/ joints QSK	Self-sealing push-in fittings/ connectors QSK, NPT	Rotary push-in fittings QSR
Pneumatic connection 1	For tubing O.D. 10 mm, 12 mm, 4 mm, 6 mm, 8 mm, Male thread G1/2, G1/4, G1/8, G3/8, R1/2, R1/4, R1/8, R3/8	For tubing O.D. 10 mm, 12 mm, 4 mm, 6 mm, 8 mm, Male thread G1/2, G1/4, G1/8, G3/8, M5, R1/2, R1/4, R1/8, R3/8	External thread 10-32 UNF-2A, external thread 1/4 NPT, external thread 3/8 NPT, external thread 1/2 NPT, For tubing O.D. 1/4 in, 1/8 in	Male thread G1/2, G1/4, G1/8, G3/8, M5, R1/2, R1/4, R1/8, R3/8
Pneumatic connection 2	For tubing O.D. 10 mm, 12 mm, 4 mm, 6 mm, 8 mm	For tubing O.D. 10 mm, 12 mm, 4 mm, 6 mm, 8 mm	For tubing O.D. 1/2 in, 1/4 in, 1/8 in, 3/8 in, 5/32 in	For tubing O.D. 10 mm, 12 mm, 4 mm, 6 mm, 8 mm
Design	L-shape, T-shape, Straight design	L-shape, Bulkhead, Straight design	L-shape, Straight design	L-shape, Straight design
Temperature-dependent operating pressure		-0.95 ... 14 bar		-0.95 ... 14 bar
Operating pressure for entire temperature range	-0.95 ... 10 bar	-0.95 ... 6 bar	-0.95 ... 10 bar	-0.95 ... 6 bar
Ambient temperature	0 ... 60°C	-10 ... 80°C	-10 ... 60°C	0 ... 60°C
Description	<ul style="list-style-type: none"> • PBT, reinforced • Resistant to welding spatter • For use in all areas where there is a risk of fire • Reliable even for applications in close proximity to welding spatter • Operating media: compressed air, vacuum, water • Straight design, L-shaped, T-shaped 	<ul style="list-style-type: none"> • Standard series • Self-sealing push-in fitting blocks the air flow after the pneumatic tubing is disconnected • PBT and nickel-plated brass • Operating medium compressed air, vacuum • Straight design, L-shaped, push-in bulkhead connector 	<ul style="list-style-type: none"> • Standard series • Self-sealing push-in fitting blocks the air flow after the pneumatic tubing is disconnected • PBT or nickel-plated brass • Operating medium compressed air, vacuum • Straight design, L-shaped 	<ul style="list-style-type: none"> • Push-in fitting, rotatable with swivel connection, rotatable by 360° with max. 500 rpm • Compact installation space • Straight design, L-shaped
online: →	qs-v0	qsk	qsk	qsr



Pneumatic fittings >

Pneumatics push-in fittings

	 Rotary push-in fittings QSR, NPT	 Fluid separator CQA	 Cartridges/blanking plugs NPQX	 Cartridges QSP
Pneumatic connection 1	external thread 1/8 NPT, external thread 1/4 NPT, external thread 3/8 NPT, external thread 1/2 NPT	For pipe and tubing O.D. 22 mm, Push-in sleeve CQ-28	Cartridge 12 mm, Cartridge 15 mm, Cartridge 10 mm	Cartridge 10 mm, 14 mm, 17 mm
Pneumatic connection 2	For tubing O.D. 1/2 in, 1/4 in, 3/8 in, 5/16 in, 5/32 in	For pipe and tubing O.D. 22 mm, Push-in sleeve CQ-28	for pneumatic tubing outside diameter 12 mm, for pneumatic tubing outer diameter 1/4", For tubing O.D. 1/4 in, 1/8 in, 10 mm, 12 mm, 3/8 in, 4 mm, 5/16 in, 5/32 in, 6 mm, 8 mm	External thread G1/8, For tubing O.D. 4 mm, 6 mm
Design	L-shape, Straight design		Straight design	Straight design
Temperature-dependent operating pressure		-0.95 ... 15 bar		
Operating pressure for entire temperature range	-0.95 ... 10 bar	-0.95 ... 7 bar	-0.95 ... 10 bar	-0.95 ... 10 bar
Ambient temperature	-10 ... 60°C	-25 ... 70°C	-10 ... 60°C	-10 ... 60°C
Description	<ul style="list-style-type: none"> • Push-in fitting, rotatable with swivel connection, rotatable by 360° with max. 500 rpm • Compact installation space • Straight design, L-shaped 	<ul style="list-style-type: none"> • Assembling and disassembling without tools • For pipes PQ-PA, PQ-AL and tubing PAN and PUN • Sturdy, air-tight connection • Straight design, T-shaped 	<ul style="list-style-type: none"> • Specially developed for VTUX valve terminal • Versions with aluminum or polyamide housing • Straight 	<ul style="list-style-type: none"> • Cartridge fittings • PBT and nickel-plated brass • Operating medium compressed air, vacuum • Straight
online: →	qsr	cq	npqx	qsp

Pneumatic fittings >

Pneumatics push-in fittings

	 Cartridges, polymer, black QSPK	 Cartridges QSPK, NPT	 Cartridges, polymer, grey QSPKG
Pneumatic connection 1	Cartridge 10 mm, 18 mm	Cartridge 18 mm	Cartridge 10 mm, 14 mm, 18 mm, 20 mm
Pneumatic connection 2	For tubing O.D. 10 mm, 3 mm, 4 mm, 6 mm, 8 mm	For tubing O.D. 1/4 in, 3/8 in	For tubing O.D. 10 mm, 12 mm, 3 mm, 4 mm, 6 mm, 8 mm
Design	L-shape, L-shape, long, Straight design	L-shape, Straight design	L-shape, L-shape, long, Straight design
Temperature-dependent operating pressure			
Operating pressure for entire temperature range	-0.95 ... 10 bar	-0.95 ... 10 bar	-0.95 ... 10 bar
Ambient temperature	-5 ... 60°C	-5 ... 60°C	-5 ... 60°C
Description	<ul style="list-style-type: none"> • Compact installation space • Threadless mounting • Straight design, L-shaped 	<ul style="list-style-type: none"> • Compact installation space • Threadless mounting • Straight design, L-shaped 	<ul style="list-style-type: none"> • Compact installation space • Threadless mounting • Straight design, L-shaped
online: →	qsp	qsp	qsp

Product overview

Pneumatic fittings >

Pneumatics push-in fittings



Cartridges
QSPKG, NPT







Cartridges
QSP, NPT

	Cartridges QSPKG, NPT	Cartridges QSP, NPT
Pneumatic connection 1	Cartridge 10 mm, 14 mm, 18 mm, 20 mm	Cartridge 10 mm, 14 mm
Pneumatic connection 2	For tubing O.D. 1/2 in, 1/4 in, 1/8 in, 3/8 in, 5/16 in, 5/32 in	For tubing O.D. 1/4 in, 5/16 in, 5/32 in
Design	L-shape, L-shape, long, Straight design	Straight design
Temperature-dependent operating pressure		
Operating pressure for entire temperature range	-0.95 ... 10 bar	-0.95 ... 10 bar
Ambient temperature	-5 ... 60°C	-5 ... 60°C
Description	<ul style="list-style-type: none"> • Compact installation space • Threadless mounting • Straight design, L-shaped 	<ul style="list-style-type: none"> • Cartridge fittings • PA reinforced or nickel plated brass • Operating media: compressed air, vacuum, (water) • Straight
online: →	qsp	qsp

Pneumatic fittings >





Barbed fittings

				
	Quick connectors NPCK	Barbed fittings CN, CRCN, FCN, L-PK, LCN, LCNH, N, RTU, SCN, T-PK, TCN, Y-PK	Quick connectors ACK, CK, CV, FCK, GCK, LCK, QCK, SCK, TCK	Barbed hose fittings C-P, N-P, N-MS
Nominal width	2 ... 6.2 mm	1.3 ... 5.3 mm	2 ... 12 mm	4 ... 16.5 mm
Pneumatic connection 1	Male thread G1/4, G1/8, G3/8, M5	For tubing O.D. 3 mm, 4 mm, 6 mm, 8 mm, Male thread G1/4, G1/8, G3/8, M3, M5	Female thread G1/2, G1/4, G1/8, G3/8, M5, For barbed connector I.D. 3 mm Via union nut, 4 mm Via union nut, 6 mm Via union nut, 9 mm Via union nut, For tubing O.D. 4 mm, 6 mm, 8 mm, Male thread G1/2, G1/4, G1/8, G3/8, M5, R1/4, R1/8, R3/8	External thread R1, External thread 3/4 NPT, External thread 1 NPT, Female thread G1/2, G1/4, G1/8, G3/8, Male thread G1/2, G1/4, G1/8, G3/4, G3/8
Pneumatic connection 2	For tubing O.D. 10 mm, 4 mm, 6 mm, 8 mm	For tubing O.D. 3 mm, 4 mm, 6 mm, 8 mm	For barbed connector I.D. 13 mm Via union nut, 3 mm Via union nut, 4 mm Via union nut, 6 mm Via union nut, 9 mm Via union nut, For tubing O.D. 4 mm, 6 mm, 8 mm	For tubing I.D. 6 mm, For tubing I.D. 19 mm, For tubing I.D. 13 mm, 9 mm, For tubing O.D. 8 mm
Design	Straight design	Straight design	L-shape, Bulkhead, T-shape, Straight design	Straight design
Operating pressure for entire temperature range	-0.95 ... 12 bar	-0.95 ... 10 bar	-0.95 ... 16 bar	-0.95 ... 16 bar
Ambient temperature	-20 ... 120°C	-10 ... 60°C	-40 ... 150°C	-10 ... 60°C
Description	<ul style="list-style-type: none"> Stainless steel design Food grade see www.festo.com/certificates/NPCK Fulfills all Clean Design requirements Operating media compressed air, vacuum, water. Water according to manufacturer's declaration, see www.festo.com/certificates/NPCK Straight 	<ul style="list-style-type: none"> Operating medium compressed air, vacuum Brass, POM, aluminum, or stainless steel Straight shape, T-shape, L-shape, Y-shape 	<ul style="list-style-type: none"> Bulkhead quick connector Sealing cap for plastic tube fittings and barbed fittings Multiple distributor Union nut for CK tube fitting Operating media: compressed air, vacuum, (water) Aluminum, steel, POM, or zinc Straight design, L-shaped, T-shaped 	<ul style="list-style-type: none"> Barbed hose fitting with or without sealing ring Tubing clip to DIN 3017 Operating medium compressed air, vacuum Brass or aluminum, steel
online: →	npck	n_070302	ck	n_cnp

Product overview





Pneumatic fittings >

Threaded fittings

	 Threaded fittings NPFC	 Blanking plugs B	 Adapters NPfV	 Reducers, sleeves, double nipples AD
Pneumatic connection 1	G1, G1/2, G1/4, G1/8, G3/4, G3/8, M3, M5, M7, R1, R1/2, R1/4, R1/8, R3/4, R3/8	Male thread G1, G1/2, G1/4, G1/8, G3/4, G3/8, M3, M5, M7, NPT1-11 1/2, NPT1/2-14, NPT1/4-18, NPT1/8-27, NPT3/4-14, NPT3/8-18	1/4 NPT, G1/4	external thread 1/8 NPT, external thread 1/4 NPT, external thread 3/8 NPT, external thread 1/2 NPT, External thread 3/4 NPT, External thread 1 NPT, Male thread G1, G1/2, G1/4, G1/8, G3/4, G3/8
Pneumatic connection 2	G1, G1/2, G1/4, G1/8, G3/4, G3/8, M3, M5, R1, R1/2, R1/4, R1/8, R3/4, R3/8		1/4 NPT, G1/4	Female thread G3/4, Female thread G1, Female thread 1/8 NPT, Internal thread 1/4 NPT, Female thread 3/8 NPT, Female thread 1/2 NPT, Female thread 3/4 NPT, Female thread 1 NPT, Female thread G1/2, G1/4, G1/8, G3/8
Operating pressure	-0.95 ... 50 bar		2 ... 8 bar	
Operating pressure for entire temperature range				-0.95 ... 10 bar
Ambient temperature	-20 ... 150°C			-10 ... 60°C
Description	<ul style="list-style-type: none"> Nickel-plated brass Sleeve Extension Double nipple Reducing nipple Operating medium: compressed air, vacuum Straight design, L-shaped, T-shaped, X-shaped, Y-shaped 	<ul style="list-style-type: none"> Aluminum, stainless steel With sealing ring Variants recommended for production facilities for the manufacture of lithium-ion batteries 	<ul style="list-style-type: none"> Adapter with filter From external thread G1/4 to internal thread G1/4 or NPT1/4 and from external thread NPT1/4 to internal thread NPT1/4 Adapter material: High-alloy stainless steel Operating medium: compressed air 	<ul style="list-style-type: none"> Interface for connecting NPT threaded fittings to components with G female threads Interface for connecting G threaded fittings to components with NPT female threads Galvanized steel
online: →	npfc	b-1	npfv	ad



Pneumatic fittings >

Threaded fittings

				
	Ring pieces, hollow bolts LK, TK, VT	Reducers, sleeves, double nipples LJK, TJK	Reducers, sleeves, double nipples E, ESK	Reducers, sleeves, double nipples QM
Pneumatic connection 1	Male thread G1/4, G1/8, G3/8, M5, G1/4, G1/8, G3/8	Male thread G1/2, G1/4, G1/8, G3/8, M3	G1/2, G1/4, G1/8, G3/4, G3/8, R1/2, R1/4, R1/8, R3/8	Female thread M5, G1, G1/2, G1/4, G1/8, G3/4, G3/8
Pneumatic connection 2	Female thread G1/4, G1/8, G3/8, For barbed connector I.D. 3 mm Via union nut, 4 mm Via union nut, 6 mm Via union nut	Female thread G1/2, G1/4, G1/8, G3/8, Internal thread M3	1/8 NPT, 1/4 NPT, 3/8 NPT, 1/2 NPT, 3/4 NPT, R1/2, R1/4, R1/8, R3/8	Internal thread M5, G1, G1/2, G1/4, G1/8, G3/4, G3/8
Operating pressure				
Operating pressure for entire temperature range	0 ... 10 bar		-0.95 ... 10 bar	
Ambient temperature			-10 ... 60°C	
Description	<ul style="list-style-type: none"> Multiple distributor consisting of hollow bolt VT and ring piece LK or TK With two to six outlets and one common air feed Operating medium compressed air, vacuum Galvanized steel 	<ul style="list-style-type: none"> T-fitting, swiveling, with female thread Elbow fitting with female thread With sealing ring 	<ul style="list-style-type: none"> For connecting pneumatic components with different threaded connections 	<ul style="list-style-type: none"> Available in different threaded connection variants RoHS compliant LABS compliant according to VDMA24364-B1/B2-L
online: →	lk	jk	esk	qm

Pneumatic fittings >

Threaded fittings

			
	Reducers, sleeves, double nipples D	Reducers, sleeves, double nipples FR	Reducers, sleeves, double nipples G
Pneumatic connection 1	M5	Male thread G1/4, G1/8, G3/8, M5	G1/4, G1/8, G3/8, M5
Pneumatic connection 2	M7	Female thread G1/4, G1/8, G3/8, Internal thread M5	G1/4, G1/8, G3/8, M5
Operating pressure			
Operating pressure for entire temperature range			
Ambient temperature			
Description	<ul style="list-style-type: none"> Reducing nipple For reducing threaded connections With sealing ring Brass 	<ul style="list-style-type: none"> With sealing ring Aluminum 	<ul style="list-style-type: none"> Elbow With sealing ring Aluminum
online: →	d	fr	g

Product overview

Pneumatic fittings >

Click fitting



Click fittings
NPKA

Pneumatic connection 1	For tubing O.D. 6 mm, Male thread G1/8
Pneumatic connection 2	For tubing O.D. 6 mm
Operating pressure [MPa]	-0.095 ... 1 MPa
Operating pressure	-0.95 ... 10 bar
Nominal width	4 mm
Ambient temperature	-10 ... 60°C
Description	<ul style="list-style-type: none"> • POM, polyamide 66 • Quick and simple tube installation using one hand • Completely plastic • Food grade see www.festo.com/certificates/NPKA • Operating media compressed air, vacuum, water. Water according to manufacturer's declaration, see www.festo.com/certificates/NPKA • No copper, fluorine or silicone • Cleanroom compatible • Easy-to-clean design – minimal corners and edges • Straight design, L-shaped, T-shaped
online: →	npka

Connection technology for fluid media

Fittings for liquid media





Fitting
NLFA

Design	Tubing mount via clamp connection, Tubing mount via barbed connector
Design	Straight design
Fluid connection	UNF1/4-28
Fluid connection 2	for tubing O.D. 3 mm, for tubing I.D. 1.2 mm, for tubing I.D. 2.1 mm, For tubing O.D. 1.6 mm (1/16"), For tubing O.D. 3.2 mm (1/8")
Operating pressure for entire temperature range	-0.75 ... 6 bar
Operating pressure [MPa] for entire temperature range	-0.075 ... 0.6 MPa
Operating pressure [psi] for entire temperature range	-10.875 ... 87 psi
Medium	Liquid media, Gaseous media
Ambient temperature	0 ... 50°C
Description	<ul style="list-style-type: none"> • For mounting in laboratory devices • Very effectively flushable due to joint without dead space • For liquid and gaseous media • Also for aggressive liquid media • Materials in contact with media: PP • For securing tubing and dosing needles • Straight design
online: →	nlfa

Piping system

Pipes

	 Plastic piping PQ-PA	 Piping PQ-AL	 Plastic-coated metal tubes PM
Outside diameter	12 ... 28 mm	12 ... 28 mm	6 ... 8 mm
Information on tubing materials	PA	Wrought aluminum alloy	Wrought aluminum alloy, PE
Temperature-dependent operating pressure	-0.95 ... 15 bar	-0.95 ... 15 bar	-0.95 ... 30 bar
Ambient temperature	-25 ... 75°C	-30 ... 75°C	-29 ... 65°C
Description	<ul style="list-style-type: none"> • Rigid pipe made from high-quality polyamide • Smooth inside wall ensures optimum flow conditions • Operating media: compressed air, vacuum, liquid media 	<ul style="list-style-type: none"> • Rigid aluminum pipe • Smooth inside wall ensures optimum flow conditions • Operating media: compressed air, vacuum, liquid media 	<ul style="list-style-type: none"> • Polyethylene, aluminum • Can be bent straight and reshaped several times without a pipe-bending device and without being damaged • Resistant to deformation • Operating medium compressed air, vacuum
online: →	pq-pa	pq-al	pm





Push-in fittings for PQ tubes

Push-in fittings for piping PQ





	 Push in fittings CQ, CQC, CQH, CQL, CQT
Pneumatic connection 1	For pipe and tubing O.D. 12 mm, 15 mm, 18 mm, 22 mm, 28 mm, Male thread G1, G1/2, G3/4, G3/8, Push-in sleeve CQ-12, CQ-15, CQ-18, CQ-22, CQ-28
Pneumatic connection 2	For pipe and tubing O.D. 12 mm, 15 mm, 18 mm, 22 mm, 28 mm, Push-in sleeve CQ-12, CQ-15, CQ-18, CQ-22, CQ-28, QS-12, QS-16
Nominal width	8 ... 24.9 mm
Temperature-dependent operating pressure	-0.95 ... 15 bar
Ambient temperature	-25 ... 70°C
Description	<ul style="list-style-type: none"> • For pipes PQ-PA, PQ-AL and tubing PAN and PUN • Operating media: compressed air, vacuum, liquid media • POM • Straight design, L-shaped, T-shaped
online: →	cq

Product overview



Couplings

				
	Coupling sockets, quick coupling plugs NPHS-D6, NPHS-S6	Quick coupling sockets, quick coupling plugs KD2, KD3, KD4, KS2, KS3, KS4	Multiple connectors KSV, KDV, KDVF	Multi-tube connectors KM
Pneumatic connection			For tubing O.D. 3, 4, 6, 8, PK-2, PK-3, PK-4, PK-6	For tubing O.D. 3, 4, 6
Pneumatic connection 1	Barbed hose fitting 9 mm, Female thread G1/2, G1/4, G3/8, Male thread G1/2, G1/4, G1/8, G3/8	For barbed fitting, inside diameter 3 mm, with union nut, For barbed fitting, inside diameter 4 mm, with union nut, For barbed fitting, inside diameter 6 mm, with union nut, Barbed hose fitting 6 mm, Barbed hose fitting 9 mm, Female thread G1/2, G1/4, G1/8, G3/8, M5, Male thread G1/2, G1/4, G1/8, G3/8, M3, M5, CK-3, CK-4, CK-6, CK-9, CN-2		
Standard nominal flow rate	875 ... 2100 l/min	44 ... 1350 l/min		
Operating pressure	-0.95 ... 12 bar	-0.95 ... 12 bar	-0.95 ... 16 bar	-0.95 ... 8 bar
Ambient temperature	-20 ... 80°C	-10 ... 60°C	-10 ... 60°C	-10 ... 60°C
Description	<ul style="list-style-type: none"> • Safety coupling • Shut-off at one end • Exhaust the air on the connector side without releasing the quick coupling • Combination of quick coupling and hand slide valve • Can be used as a shut off valve • Nickel-plated brass or galvanized hardened steel 	<ul style="list-style-type: none"> • Quick coupling for standard applications without safety function • Shut off at one or both ends • With external or internal thread or with barbed fitting or quick connector • Nickel-plated brass, PP • Operating medium compressed air, vacuum 	<ul style="list-style-type: none"> • POM, aluminum, brass • Multi-plug, multi-socket • Terminal plug and terminal socket • Operating medium compressed air, vacuum 	<ul style="list-style-type: none"> • Polymer, brass • For max. 22 lines • Used as control cabinet outlets • Operating medium compressed air, vacuum
online: →	nphs	kd1	ksv	km

Distributors

	 Multiple distributors QSLV, QSQ, QST3	 Multiple distributors QSYTF	 Distributors FR	 Distributors CQD
Pneumatic connection 1	For tubing O.D. 10 mm, 6 mm, 8 mm, Male thread G1/2, G1/4, G1/8, G3/8, R1/2, R1/4, R1/8, R3/8	Male thread G1/2, G1/4, G1/8, G3/8, R1/2, R1/4, R1/8, R3/8	Female thread G1/2, G1/4, G1/8, G3/8, Internal thread G3/4	Female thread G1/2
Pneumatic connection 2	For tubing O.D. 10 mm, 12 mm, 4 mm, 6 mm, 8 mm	Female thread G1/2, G1/4, G1/8, G3/8, For tubing O.D. 10 mm, 12 mm, 6 mm, 8 mm	Female thread G1/2, G1/4, G1/8, G3/8, Internal thread M3, M5	Female thread G1/2
No. of supply lines	1	1	1	1
No. of outlets	2, 3, 4, 6	3	3, 8, 9, 12	4
Max. rotational speed				
Description	<ul style="list-style-type: none"> • PBT and nickel-plated brass • Rotatable 360° • Reducing design • Operating media: compressed air, vacuum, (water) • Straight design, L-shaped, T-shaped 	<ul style="list-style-type: none"> • PBT and nickel-plated brass • Rotatable 360° • Operating media: compressed air, vacuum, (water) • Y-shape 	<ul style="list-style-type: none"> • Aluminum • 4, 8, 9, or 12 connections • Operating medium compressed air, vacuum 	<ul style="list-style-type: none"> • POM • Operating medium compressed air, vacuum
online: →	qslv	qsytf	fr	cq



Distributors

	 Rotary distributors GF	 Multiple distributor QBT3	 Multiple distributors QSLV, QSQ, QST3
Pneumatic connection 1	Male thread G1/4, G3/8, G1/2, G1/4, G1/8	For tubing O.D. 1/4 in, 3/16 in, 3/8 in, 5/16 in	external thread 1/8 NPT, external thread 1/4 NPT, external thread 3/8 NPT, external thread 1/2 NPT, For tubing O.D. 1/4 in, 5/16 in
Pneumatic connection 2	Female thread G1/4, G3/8, G1/2, G1/4, G1/8, M5	For tubing O.D. 1/4 in, 3/16 in, 5/16 in, 5/32 in	For tubing O.D. 1/2 in, 1/4 in, 3/8 in, 5/32 in
No. of supply lines			1
No. of outlets			2, 3, 4, 6
Max. rotational speed	300 ... 3000 rpm		
Description	<ul style="list-style-type: none"> • 2 or 4 axial and radial outlets • Single or multiple rotary distributor • Operating medium compressed air, vacuum • Brass, hardened steel 	<ul style="list-style-type: none"> • Standard series for pneumatic tubing with imperial dimensions • PBT • 3 outlets • Reducing design • Operating medium compressed air, vacuum 	<ul style="list-style-type: none"> • PBT and nickel-plated brass • Rotatable 360° • Reducing design • Operating media: compressed air, vacuum, (water) • Straight design, L-shaped, T-shaped
online: →	gf	qb	qslv

Product overview

Pneumatic hose sleeves & guards

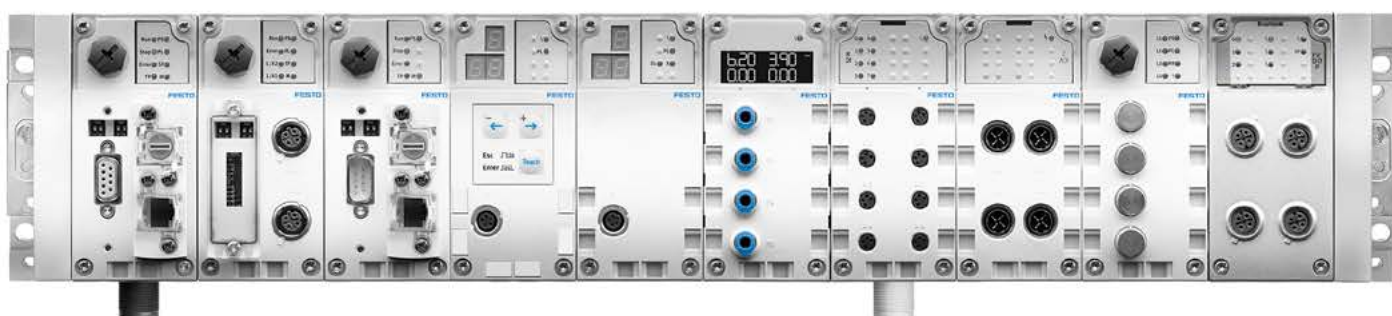

Protective conduit systems

	 <p>Protective conduits MK, MKG, MKR, MKV</p>	 <p>Fittings HMZAS, HMZV, MKA, MKGV, MKM, MKRL, MKRS, MKRT, MKRV, MKVM, MKVV, MKY</p>
Mounting position	Any	Any
Description	<ul style="list-style-type: none"> • For protecting pneumatic tubing and electrical connector cables • Galvanized steel, PA, PP, PVC spring steel • Metal or plastic design • High alternating bending strength 	<ul style="list-style-type: none"> • Installation kit • Junction box • Adapter connector • Pneumatic fitting • Lock nut • Protective conduit connector • Y-distributor • Polymer, polyamide, nickel-plated brass
online: →	mkg	mka





Product overview

Pneumatic and electropneumatic controllers

	 Steppers TAA, TAB	 Pulse oscillators VLG
Operating pressure		3.5 ... 10 bar
Operating pressure [MPa]		0.35 ... 1 MPa
Explosion prevention and protection	Zone 1 (ATEX), Zone 2 (ATEX), Zone 21 (ATEX), Zone 22 (ATEX)	
Description	<ul style="list-style-type: none"> For ensuring a logical program sequence Poppet valve with integrated AND as well as OR element 	<ul style="list-style-type: none"> For generating infinitely adjustable signals in controllers For high-speed cylinder movements of diaphragm cylinders, single-, and double-acting cylinders
online: →	taa	vlg

Electronic controllers

	 Control unit CEPE	 Controllers CECC-D, CECC-LK, CECC-S
CPU data	8 GB RAM, Dual core 2.2 GHz	Dual core 500 MHz
Operating voltage		19.2 - 30 V DC, 20.4 - 30 V DC
Fieldbus interface, protocol	EtherCAT	
Fieldbus interface, connection technology		Plug, Sub-D, 9-pin
Ethernet interface, protocol	TCP/IP	OPC-UA
Ethernet interface, function	Cloud connection, Network	
Ethernet interface, connection technology	RJ45	
NEW	<ul style="list-style-type: none"> New 	
Description	<ul style="list-style-type: none"> High-performance industrial PC with Festo AX OS real-time operating system Based on PLCnext Technology – the open ecosystem for modular automation Extension of IEC standards with IT languages such as Python and C++ to open up new automation potentials Easy programming with CODESYS or Visual Studio Code Extended functionality available via apps from the Festo and PLCnext App Store Seamless connectivity from OT servo technologies to IT cloud services Available in two different software versions (C1/IOT & M1/Motion) 	<ul style="list-style-type: none"> Compact programmable logic controller Programming with CODESYS to IEC 61131-3 12 digital inputs, 8 digital outputs, and also two high-speed counters up to 200 kHz Ethernet 10/100 Mbit/s USB interface for data transfer
online: →	cepe	cecc

Software tools



Connectivity Finder



This tool can be used to find the optimum way to connect a Festo solution to your preferred (non-Festo) controller. You will also be provided with expert knowledge for your selected connection option, making it really easy to integrate the Festo solution into your machine.

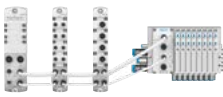
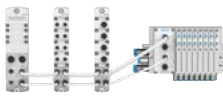

This tool can be found at
[→ www.festo.com/x/connectivity-finder](http://www.festo.com/x/connectivity-finder)

Remote I/O and network interface components



	 Remote I/O systems CPX-AP-A	 Automation systems CPX-AP-I	 For automation systems CPX-AP-I	 Remote I/O system CPX-AP-L
Address capacity, inputs	1024 ... 4096 byte		244 ... 2048 byte	2 byte
Max. no. of inputs				
Address volume, outputs	1024 ... 4096 byte		244 ... 2048 byte	1 byte
Electrical actuation	AP interface, Ethernet			
Protocol	AP		IO-Link®	AP
Description	<ul style="list-style-type: none"> • Modular and lightweight IO system in IP65/IP67 • Highly flexible remote IO system with maximum performance • Can be expanded and easily combined with CPX-AP-A and CPX-AP-I to form an integrated system • End-to-end connectivity with extended diagnostics option increases machine availability and productivity • Simple integration into the controller of your choice: PROFINET, PROFIBUS, EtherCAT®, EtherNet/IP, ModbusTCP, Profibus • Module for IO-Link® available • Fits perfectly into our holistic product portfolio of electromechanical actuators, motors, drive controllers and control systems • High-performance remote I/O system that flexibly networks 80 modules in real time with a 200 Mbaud data rate • Sustainable in operation due to energy shutdown 	<ul style="list-style-type: none"> • Fits perfectly into our holistic product portfolio of electromechanical actuators, motors, drive controllers and control systems • High-performance remote I/O system that flexibly networks 80 modules in real time with a 200 Mbaud data rate • End-to-end connectivity with extended diagnostics option increases machine availability and productivity • Easy to integrate into the controller of your choice: PROFINET, EtherCAT, EtherNet/IP, ModbusTCP • Real-time capability and deterministic system behavior enable a cycle time of up to 250 µs • Cable lengths of up to 50 m between each module enable giant system dimensions • IO-Link master and configuration software enable any IO-Link devices to be integrated simply • Ethernet performance up to valve manifold and digital or analog I/O modules • Sustainable in operation due to energy shutdown 	<ul style="list-style-type: none"> • Fits perfectly into our holistic product portfolio of electromechanical actuators, motors, drive controllers and control systems • Decentralized and lightweight I/O system in IP65/IP67 • Highly flexible remote IO system with maximum performance • Can be expanded and easily combined with CPX-AP-I and CPX-AP-A to form an integrated system • End-to-end connectivity with extended diagnostics option increases machine availability and productivity • Easy to integrate into the controller of your choice: PROFINET, EtherCAT, EtherNet/IP, ModbusTCP • Module for IO-Link® available • High-performance remote I/O system that flexibly networks 80 modules in real time with a 200 Mbaud data rate • Cable lengths of up to 50 m between each module enable giant system dimensions 	<ul style="list-style-type: none"> • Decentralized and lightweight I/O system in IP20 • Highly flexible remote IO system with maximum performance • Can be expanded and easily combined with CPX-AP-I and CPX-AP-A to form an integrated system • End-to-end connectivity with extended diagnostics option increases machine availability and productivity • Simple integration into the controller of your choice: PROFINET, PROFIBUS, EtherCAT®, EtherNet/IP, ModbusTCP, Profibus • High-performance remote I/O system that flexibly networks 80 modules in real time with a 200 Mbaud data rate • Cable lengths of up to 50 m between each module enable giant system dimensions • Fits perfectly into our holistic product portfolio of electromechanical actuators, motors, drive controllers and control systems
online: →	cpx-apa	cpx-api	cpx-api	cpx-apl

Product overview

Remote I/O and network interface components

	 Input modules for installation system CTEL CTSL	 Fieldbus modules CTEU	 Terminals CPX
Address capacity, inputs		2 ... 64 byte	64 byte
Max. no. of inputs	16		
Address volume, outputs		2 ... 64 byte	64 byte
Electrical actuation			Fieldbus, Integrated controller
Protocol	I-Port, IO-Link®	AS-Interface, CANopen, CC-LINK®, DeviceNet, EtherCAT, EtherNet/IP, PROFINET, Modbus® TCP, PROFIBUS DP	
Description	<ul style="list-style-type: none"> • For installation system CTEL • For recording sensor input signals • Display of the input statuses for each input signal via an assigned LED • Diagnostic LED for short circuit/overload in sensor supply 	<ul style="list-style-type: none"> • For pneumatic valve manifolds VTUG, MPA-L, VTOC • Can be expanded into the installation system CTEL • Fieldbus-typical LEDs, interfaces, and switching elements • Isolated power supply for electronics and pneumatic valves 	<ul style="list-style-type: none"> • Automation platform • Open to all common fieldbus protocols and Ethernet • Integrated diagnostic and maintenance functions • Can be used as stand-alone remote I/O or with valve manifolds MPA-S, MPA-L, VTSA/VTSA-F • Interlinking block in either polymer or metal with individual linking • Analog inputs and outputs, 2-way/4-way, with optional HART protocol
online: →	ctsl	cteu	cpx

Remote I/O and network interface components

	 Electrical interface CPX-CTEL	 AS-Interface® module ASI
Address capacity, inputs	32 byte	
Max. no. of inputs		
Address volume, outputs	32 byte	
Electrical actuation		
Protocol	I-Port, IO-Link®	
Description	<ul style="list-style-type: none"> • CPX-CTEL master module with 4 I-Port connections • Decentralized pneumatic components and sensors for fast processes • Standardized M12 connections 	<ul style="list-style-type: none"> • Accessories for the AS-Interface® installation system • Compact I/O modules (IP65, IP67)
online: →	cpx-ctel	as-interface

Software tools

**Commissioning software
Festo Automation Suite**



Quickly and safely to an operational drive system – the Festo Automation Suite combines parameterization, programming and maintenance of complete drive systems from the mechanics to the control system – and all with just one software. Perfect for making industrial automation simple, efficient and seamless.

Plug-in automation system CPX-E

- Controller programming in CODESYS as a system expansion for applications ranging from SoftMotion to robotics
- Just two mouse clicks instead of 100: greatly simplified integration of the servo drive CMMT-AS into the control program with CPX-E-CEC
- Conveniently install the plug-in using the software
This tool can be found
- on our website at www.festo.com/AutomationSuite

Controllers and motion control



**Automation systems
CPX-E**

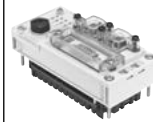



**Motor controllers
CPX-CEC-M1**



Max. address capacity inputs	64	
CPU data		800 MHz processor, 256 MB RAM, 32 MB Flash
Processing time		Approx. 200 µs/1 k instruction
Degree of protection	IP20	IP65, IP67
Configuration support		CODESYS V3
Fieldbus interface, type		CAN bus
Fieldbus interface, connection technology		Plug, Sub-D, 9-pin
Description	<ul style="list-style-type: none"> • Fits perfectly into our holistic product portfolio of electromechanical actuators, motors, drive controllers and control systems • Modern control system with high performance • Fieldbus master interfaces, EtherCAT® master, fieldbus slave interfaces, PROFINET, EtherNet/IP, PROFIBUS, EtherCAT digital input modules (16DI), digital output modules (8DO/0.5A) • Analog input modules (current, voltage), analog output modules (current, voltage) • Modern programming with CoDeSys V3 to IEC 61131-3 • Integration of SoftMotion functions (SoftMotion) • Compact I/O assembly • Easy mounting of the control system 	<ul style="list-style-type: none"> • Easy actuation of valve manifold configurations • Programming with CODESYS to IEC 61131-3 • Connection to all fieldbuses as a remote controller and for pre-processing • Actuation of electric actuators via CANopen • SoftMotion functions for coordinated multi-axis movements
online: →	cpx-e	cpx-cec-m1

Product overview

Operator units



	 Operator unit CDSV	 Operator units CDSA	 IO-Link Master USB CDSU-1
Conforms to standard			EN 61131-9
DC operating voltage range	15 ... 30 V	19.2 ... 30 V	
Electrical IO-Link® connection, connection type			Socket
Electrical connection, IO-Link®, connection technology			M12x1, A-coded as per EN 61076-2-101
Electrical IO-Link® connection, number of pins/wires			5
Protocol			IO-Link®
Display type	Illuminated LCD		
Display		LCD display, With backlighting	
Display size		7 in	
Display resolution		WSVGA, 600 x 1024 pixels	
NEW	<ul style="list-style-type: none"> • New 		
Description	<ul style="list-style-type: none"> • Display and operating panel for the VEFC mass flow controller • Compact design 30 x 30 mm • Diagnostic function • Parameterization function of the basic device • High-contrast display with blue backlight 	<ul style="list-style-type: none"> • For mobile commissioning and optimization • Integrated reporting system and user administration in combination with the Festo robotics library • Junction box for installation in a control cabinet and various cable lengths available • Interfaces for Ethernet, RS-422-A/RS-232-C, USB host/USB client • With color touchscreen 	<ul style="list-style-type: none"> • Allows Festo IO-Link® products to be commissioned quickly and intuitively • Compact, cost-effective, powerful • Universal connections • Galvanic isolation • Connecting cables for almost all IO-Link® devices from Festo • For IO-Link® devices with protocol version 1.1 or 1.0 • Supports data storage
online: →	cdsv	cdsa	cdsu

Operator units

	 Operator units CDSB	 Operator units CDPX
Conforms to standard		
DC operating voltage range	4.5 ... 5.5 V	10 ... 32 V
Electrical IO-Link® connection, connection type		
Electrical connection, IO-Link®, connection technology		
Electrical IO-Link® connection, number of pins/wires		
Protocol		
Display type		Color TFT
Display	Color TFT	With backlighting
Display size	1.77"	5", 10.1", 15.6", 21.5", 7 in, 4.3 in
Display resolution	128x160 pixels	1024x600 pixels, 1025x600 pixels, 1280x800 pixels, 1366x768 pixels, 1920x1080 pixels, 800x480 pixels, 480x272
Description	<ul style="list-style-type: none"> • Pluggable display and control unit for the servo drive CMMT and automation system CPX-E • Color touchscreen • Diagnostic function • Very compact size • Mini USB interface • Update function for basic unit 	<ul style="list-style-type: none"> • Cost-optimized for simple visualization tasks, e.g. of process data • Powerful processors combined with wide-screen technology • Ideally matched to CODESYS controllers from Festo or ModbusTCP networks • Integrated EtherNet interfaces • With touchscreen • Variants according to EU explosion protection directive (ATEX) and in IP67 suitable for process automation requirements
online: →	cdsb	cdpx

Product overview

Positioners

	 Positioners CMSH	 Positioners CMSX
Mode of operation	Double-acting, Single-acting	Double-acting, Single-acting
Standard nominal flow rate		50 ... 130 l/min
Ambient temperature	-40 ... 80°C	-5 ... 60°C
Reference value		
DC operating voltage range		21.6 ... 26.4 V
Operating pressure [MPa]	0.14 ... 0.8 MPa	0.3 ... 0.8 MPa
Operating pressure	1.4 ... 8 bar	3 ... 8 bar
Operating pressure [psi]	20.3 ... 116 psi	43.5 ... 116 psi
Design features	Safety position - pneumatic outlets closed, Safety pneumatic output 2 exhausted, Safety pneumatic output 4 pressurized	Safety position – pneumatic outlet 4 exhausted, Safety position – pneumatic output 2 pressurized, Safety position - pneumatic outlets closed
Degree of protection	IP66, IP67	IP65
Type of mounting	With accessories, as per VDI/VDE 3845, to VDI/VDE 3847-2	With accessories
Information about housing material	Aluminum, powder-coated	PC-reinforced
Description	<ul style="list-style-type: none"> • Intelligent, digital electropneumatic positioner with HART communication • Fast and precise position control of single-acting and double-acting pneumatic rotary and linear actuators • With integrated or external path/angular detection • Commissioning, operation, servicing and diagnostics on the local display via the user-friendly software menu or via remote access via EDD-based (Electronic Device Description) or FDT-based (Field Device Tool) transmission • 2-conductor technology • Perfect interaction with the VTOP pneumatic extension modules • Variants with safety functions • Sustainable operation due to efficient control 	<ul style="list-style-type: none"> • Digital, electropneumatic positioner • Simple and efficient position control of single-acting and double-acting pneumatic rotary and linear actuators • Sustainable thanks to extended life cycle due to simplified reparability • With integrated or external path/angular detection • Simple commissioning through automatic initialization function • Intuitive menu navigation • 4-conductor technology • Variants with safety functions
online: →	cmsh	cmsx

Documentation

	 Descriptions
Description	<ul style="list-style-type: none"> • Manuals, operating instructions
online: →	p.be

Training systems

Learning systems





EduTrainer Universal
D:ET-SPS



Description	<ul style="list-style-type: none"> • PLC EduTrainer® support system for use in teaching and training • Equipped with PLCs from different manufacturers • Two series: universal and compact • Equipped with 19" simulation modules • Individually configurable or pre-assembled
online: →	edutrainner



Product overview





Product overview

	 Festo AX Controls CODESYS PLC GSBE-PLC	 Festo AX Controls Motion Robotic GSBE-MR	 Festo AX Controls WebIQ GSBE-IQ
NEW	<ul style="list-style-type: none"> • New 	<ul style="list-style-type: none"> • New 	<ul style="list-style-type: none"> • New
Description	<ul style="list-style-type: none"> • CODESYS app for Festo AX Controls controllers • From 256 to unlimited number of I/Os • For controlling four to an unlimited number of axes • Modular licensing concept for user-centered expansion of functions • Easy expansion of CNC and robotics functionality via the advanced license 	<ul style="list-style-type: none"> • Motion Robotic Package for Festo AX Controls controllers • Enables programming with FTL (Festo Teach Language) for precise control • Extended functions for more complex machine control for CNC or robotics applications • Modular licensing concept for user-centered expansion of functions • API for easy programming in other languages such as Python 	<ul style="list-style-type: none"> • WebIQ app for Festo AX Controls controllers • Web-based HMI system for individual real-time monitoring • Responsive design for use on all devices and screen sizes • User-friendly no-code/low-code environment for short development cycles • Easy to use with no special skills required • Seamless integration and compatibility with proven Festo products • Modular licensing concept for customized solutions
online: →	gsbe-plc	gsbe-mr	gsbe-iq



	 Festo AX Controls Python GSBE-PY	 Festo AX Controls Node-RED GSBE-NR
NEW	<ul style="list-style-type: none"> • New 	<ul style="list-style-type: none"> • New
Description	<ul style="list-style-type: none"> • Python app for Festo AX Controls controllers • Web-based IDE • Easy programming language for different applications • Possible to use existing libraries • Portable programming language • Purchase license for an unlimited period of use 	<ul style="list-style-type: none"> • Node-RED app for Festo AX Controls controllers • Flow-based language for various applications and monitoring functionalities • Visually controlled user interface for easy programming via web browser • Web-based IDE • With pre-installed demo sequence for easy understanding • Free software license for an unlimited period of use
online: →	gsbe-py	gsbe-nr

	 Smartenance GASM	 Festo AX Data Access GASA-DA	 Festo AX Motion Insights Pneumatic GASA-MIP
NEW	• New		• New
Description	<ul style="list-style-type: none"> • Combines maintenance and servicing software (CMMS) with a machine logbook in a single solution • Web application for maintenance or production managers and mobile app for maintenance staff and operators • Seamless integration with SAP Maintenance Management (S4/HANA) • Optimizes processes and reduces unplanned downtime • Integration of AI software enables predictive maintenance (condition-based maintenance) • Development of an internal knowledge database for rapid problem solving 	<ul style="list-style-type: none"> • Access to Festo components (brownfield or greenfield) • IoT gateway with protocol translator from OT to IT (MQTT) • Reduction of IT administration with plug and play solution • Simplifies asset management, creates transparency • Monitors existing and new processes (process data) • Enables data-driven solutions (e.g. status and diagnostic messages) • Can save hundreds of hours of work on many components 	<ul style="list-style-type: none"> • Continuous monitoring of the pneumatic drive chain • Detects wear and anomalies, makes maintenance plannable • Connectivity through PLC, no data science expertise required • Simple visualization and access via browser • Works with drives from all manufacturers: one standard app for all • Reduces unplanned downtime, increases productivity (OEE) • Fixed price per cylinder makes the investment plannable
online: →	gasm	gasa	gasa



	 Festo AX Motion Insights Electric GASA-MIE	 Festo AX Energy Insights GASA-EI
NEW	• New	• New
Description	<ul style="list-style-type: none"> • Continuous monitoring of the electric drive chain for wear and anomalies • Plug and play with CMMT-AS/ST servo drives from Festo • No intervention in the PLC necessary, no data science expertise required • Simple visualization and access via browser • Reduces unplanned downtime, increases productivity (OEE) • Fixed price per servo drive makes the investment schedulable 	<ul style="list-style-type: none"> • Continuous energy monitoring of compressed air and electrical energy • Automatic leakage detection thanks to AI fingerprint and intelligent consumption analysis • Works with sensors from Festo as well as third-party suppliers: Pressure, flow and electrical energy meters • Simple visualization and access via browser • Ensures transparency about consumption and helps to track optimization measures • Fixed price per cylinder makes the investment plannable
online: →	gasa	gasa



Product overview

Software

	 Festo Positioning CNC Robotics GSBE-R	 Motion apps GAMM	 Software Packages GSAY
NEW	<ul style="list-style-type: none"> • New 		
Description	<ul style="list-style-type: none"> • Comprehensive Festo software duo for electric drives and controllers • Versatile for CNC, robotics and pick and place applications • Host interface to third-party controllers such as Beckhoff, Omron, Rockwell, Siemens • Precise control of complex trajectories and space curves • Flexible combination of functions and methods for customized solutions • Easy integration of motion into customized program sequences • Useful tools for implementing, commissioning, testing and analysis • Practical tools: Status monitors, motion cockpits, CNC editor, path view • User-friendly, even for beginners in CNC or robotics technology 	<ul style="list-style-type: none"> • Open and closed loop control programs for pneumatic valves VEVN • A new dimension in flexibility thanks to Motion Apps – a single pneumatic valve with nine different functions • Accelerated engineering processes • Short response times without the need to adapt the hardware • Reduced system complexity • Shorter time to market for your application 	<ul style="list-style-type: none"> • Licenses for the application software for the YJKP servo press kit
online: →	gsbe-r	gamm	gsay

Software

	 Software Packages GSAY	 License PA-Toolkit GSPL	 License GSAR
Description	<ul style="list-style-type: none"> • Licenses for software or software libraries for motion or robotics applications 	<ul style="list-style-type: none"> • For simple and intuitive development of control logics and user interfaces • For implementing your automation solutions without in-depth programming knowledge • Extensive set of predefined function blocks and associated visualization elements for the CODESYS development environment and CODESYS-based controllers • Compatible with CPX-E-CEC controller, CPX-CEC control block 	<ul style="list-style-type: none"> • Software license for controlling a Festo handling system • For point to point interpolation or Cartesian interpolation
online: →	gsay	gspl	gsar

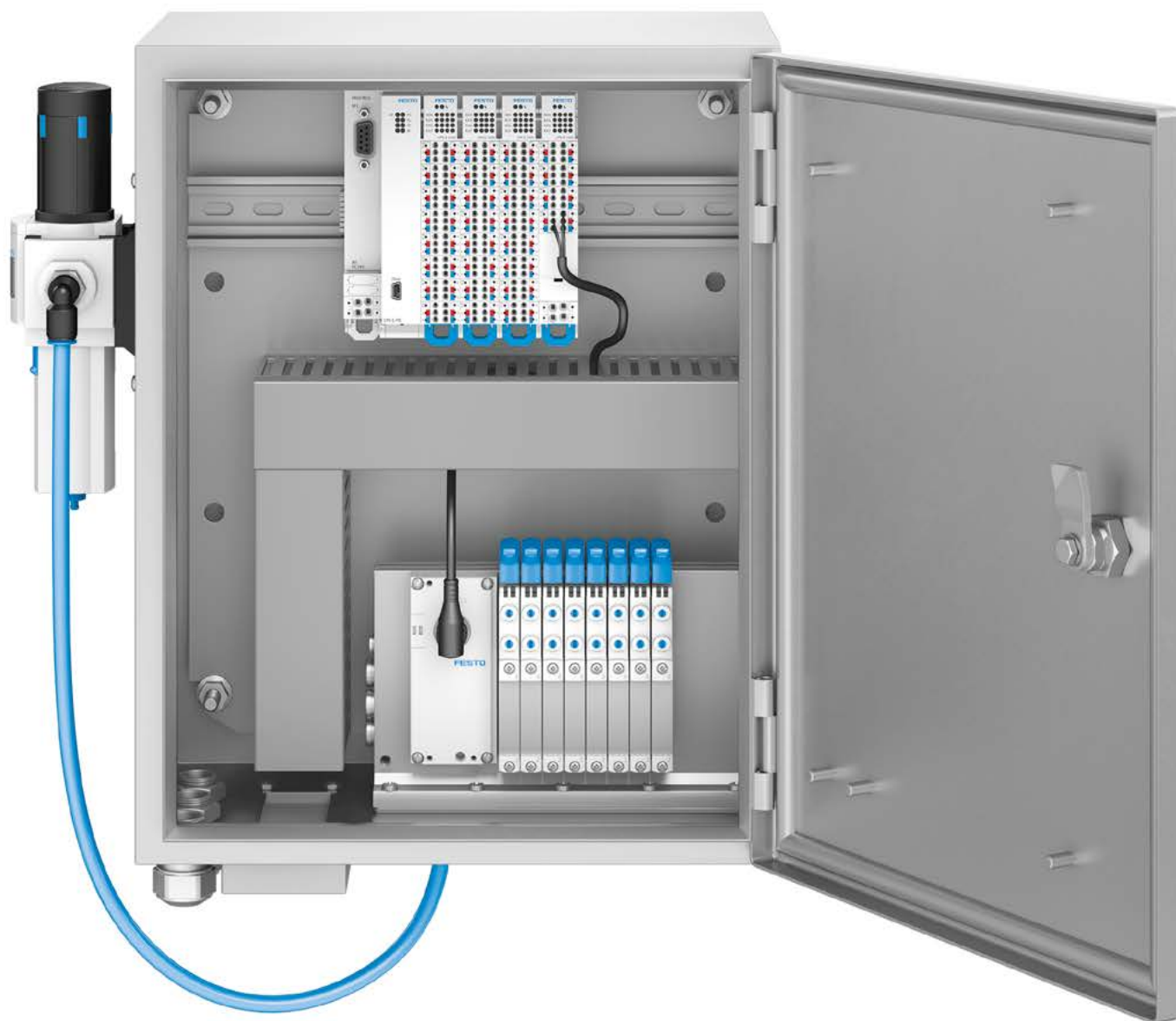

	 Smartenance GASL	 Software (FluidDraw® P6/365) GSWF	 Eplan projects (schematic solution) GDDE
NEW	<ul style="list-style-type: none"> • New 		
Description	<ul style="list-style-type: none"> • Access to the Festo Learning Experience (Festo LX) – the digital all-in-one learning portal for personalized learning experiences • Content: Benefit from more than 700 courses in various learning formats (e-learning courses, learning videos, learning success checks, hardware-related courses,...) from more than 40 ready-made learning paths • Customization: Customize the learning content or learning paths from Festo LX to your needs and create your own content with our AI-powered content creator • Efficiency: access Festo LX from any device, anywhere and at any time • Easy to manage: It has never been easier to assign content, assess progress and achievements, manage access rights and export learning outcomes 	<ul style="list-style-type: none"> • Generate pneumatic and electrical circuit diagrams quickly and easily • Documentation of complete systems • Extensive standard symbol library • Insert products directly via Festo's integrated product catalog • Automatically generated evaluations of article data and circuit information • Automatic equipment labelling with customization options • Create your own symbols, libraries, product databases or drawing frames 	<ul style="list-style-type: none"> • Get complete EPLAN projects of complex products in minutes • Simple integration into existing EPLAN projects • Significant time saving • More security on completeness
online: →	gasl	gswf	gdde

Product overview





Product overview

Control cabinets

	 Factory automation	 Process automation	 Control cabinets for handling systems
Technical data	<ul style="list-style-type: none"> • Simple to complex control cabinet designs • Application-specific combination of components • Fully tested, with test certificate • Ready-to-install • Complete documentation • Design conforms to: <ul style="list-style-type: none"> – EN 60204-1 – ATEX zone 1 and 21 (pneumatic only), ATEX zone 2 and 22 (electric and electropneumatic) – UL-508 A • Implementation of safety functions • Different bus technologies 	<ul style="list-style-type: none"> • Simple to complex control cabinet designs • Application-specific combination of components • Different operating voltages • Fully tested, with test certificate • Ready-to-install • Complete documentation • Design conforms to: <ul style="list-style-type: none"> – EN 60204-1 – ATEX zone 1 and 21 (pneumatic only), ATEX zone 2 and 22 (electric and electropneumatic) – UL-508 A • Implementation of safety functions • Wide range of bus technologies • Compliance with special cleanliness and hygiene requirements • Special materials • Protected against the ingress of liquids and foreign matter • Heating or cooling elements • Intrinsically safe valve terminal technology • Hot swap inspection window 	<ul style="list-style-type: none"> • Simple to complex control cabinet designs • Control of motion sequences with up to 6 axes • Application-specific combination of components • Use of the latest innovations and technologies • Fully tested, with test certificate • Ready-to-install • Complete documentation • Design conforms to: <ul style="list-style-type: none"> – EN 60204-1 – ATEX zone 1 and 21 (pneumatic only), ATEX zone 2 and 22 (electric and electropneumatic) – UL-508 A • Implementation of safety functions • Wide range of bus technologies • Function modules for motion applications • Host modules for easy connection to the customer's control environment
Description	<ul style="list-style-type: none"> • Made-to-measure control cabinets • Pneumatic, electric, combined • Individually configured • Adapted to requirements in industrial automation • Design and sizing included 	<ul style="list-style-type: none"> • Made-to-measure control cabinets • Pneumatic, electric, combined • Individually configured • Adapted to requirements in process automation • Design and sizing included 	<ul style="list-style-type: none"> • Made-to-measure control cabinets for handling systems • Software package for third-party devices included • Individually configurable • Adapted to requirements for handling solutions → chapter 7 „Handling systems and industrial robots“ see page 97
Just ask us: →	www.festo.com/contact	www.festo.com/contact	www.festo.com/contact

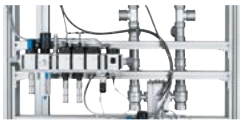
Mounting and installation plates



	 Mounting plates	 Hall installation plates (HIP) for body assembly	 Robot installation plates (RIP) for body assembly
Technical data	<ul style="list-style-type: none"> • Customised support plate shape • Support plate available in different materials • Application-specific combination of components • Fully assembled, connected and wired • Defined interfaces • Ready-to-install • Fully tested, with test certificate • Complete documentation • Design conforms to: <ul style="list-style-type: none"> – EN 60204-1 – ATEX zone 1 and 21 (pneumatic only), ATEX zone 2 and 22 (electric and electropneumatic) – UL-508 A • Implementation of safety functions 	<ul style="list-style-type: none"> • Media supply for compressed air and cooling water for welding cells • Made to measure: profile as support element, design perfectly adapted to the installation space, for installation within safety barriers • Labelling: customised labelling for safe operation • Fast installation: thanks to assembly according to the customer's specification • Medium water: fittings for liquid media 	<ul style="list-style-type: none"> • Media supply for compressed air and cooling water for welding robots • Protection against ambient conditions through the use of special materials, such as hoses and fittings resistant to welding spatter • Protection against environmental influences to prevent damage to the installation • Made to measure: profile as support element, design perfectly adapted to the installation space • Cooling water suction cylinder for drawing in cooling water when changing welding caps • Water flow sensor: measures flow rate, volume and cooling water temperature – to monitor the welding process • Easy to maintain thanks to removable fittings
Description	<ul style="list-style-type: none"> • Machine-specific pre-assembly of pneumatic and electric components on support plate • Tubing and wiring included • Defined interfaces for simple installation directly in the system 	<ul style="list-style-type: none"> • Controls and monitors the compressed air and cooling water supply for whole welding cells 	<ul style="list-style-type: none"> • Controls and monitors the compressed air and cooling water supply for individual welding guns
Just ask us: →	www.festo.com/contact	www.festo.com/contact	www.festo.com/contact

Software tools



<p>Festo Design Tool 3D</p> 	<p>The Festo Design Tool 3D is a 3D product configurator for generating specific CAD product combinations from Festo.</p> <p>The configurator makes your search for the right accessory quicker, easier, and more reliable</p> <p>You can then order the module that has been created as a single order item – either completely pre-assembled or as individual parts in a single box. This considerably reduces your bill of materials, and downstream processes such as product ordering, order picking and assembly are significantly simplified.</p> <p>This tool can be found at → www.festo.com/fdt-3D</p>
--	---

Product overview

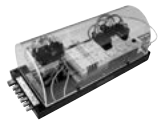
Modules

	 Modules	 Cartridge solutions	 Sheet metal structures and special enclosures
Technical data	<ul style="list-style-type: none"> • Combination of various pneumatic and/or electric components to create a single unit • Application-specific combination of components • Accessories mounted on sub-assembly • Use of the latest innovations and technologies • Ready-to-install • Fully tested, with test certificate • Complete documentation • Design conforms to: <ul style="list-style-type: none"> – EN 60204-1 – ATEX zone 1 and 21 (pneumatic only), ATEX zone 2 and 22 (electric and electropneumatic) – UL-508 A • Implementation of safety functions 	<ul style="list-style-type: none"> • Space-saving thanks to extremely compact design • Pneumatic functions integrated into a compact enclosure • Enclosure available in different materials • No need for tubing work • Minimum cabling work • Pronounced design freedom • Variable integration options on and within the machine • Robust design • 100% tested • Ready-to-install • Complete documentation 	<ul style="list-style-type: none"> • Sheet-metal structures <ul style="list-style-type: none"> – Customised shape and size – Reduced weight and number of assembly parts • Special housing <ul style="list-style-type: none"> – Customised shape – Customised dimensions – Various materials – Compact, space-saving format – Protection against environmental influences and unauthorised access • In combination <ul style="list-style-type: none"> – Alternative to conventional control cabinets – Variable integration options on and within the machine – Short tubing and cable lengths – Attractive design
Description	<ul style="list-style-type: none"> • Pneumatic and electric components pre-assembled to create a function unit • Can be combined from around 30,000 catalogue components • Connections included • For integration in machines 	<ul style="list-style-type: none"> • Different pneumatic functions are integrated in one component • Individual enclosure not used any longer • Ideal where a highly compact design is required 	<ul style="list-style-type: none"> • Reduced weight thanks to optimal use of materials with sheet-metal structures • Protection against environmental influences and unauthorised access in the special housing • Ideally combined as a control cabinet directly in the system
Just ask us: →	www.festo.com/contact	www.festo.com/contact	www.festo.com/contact

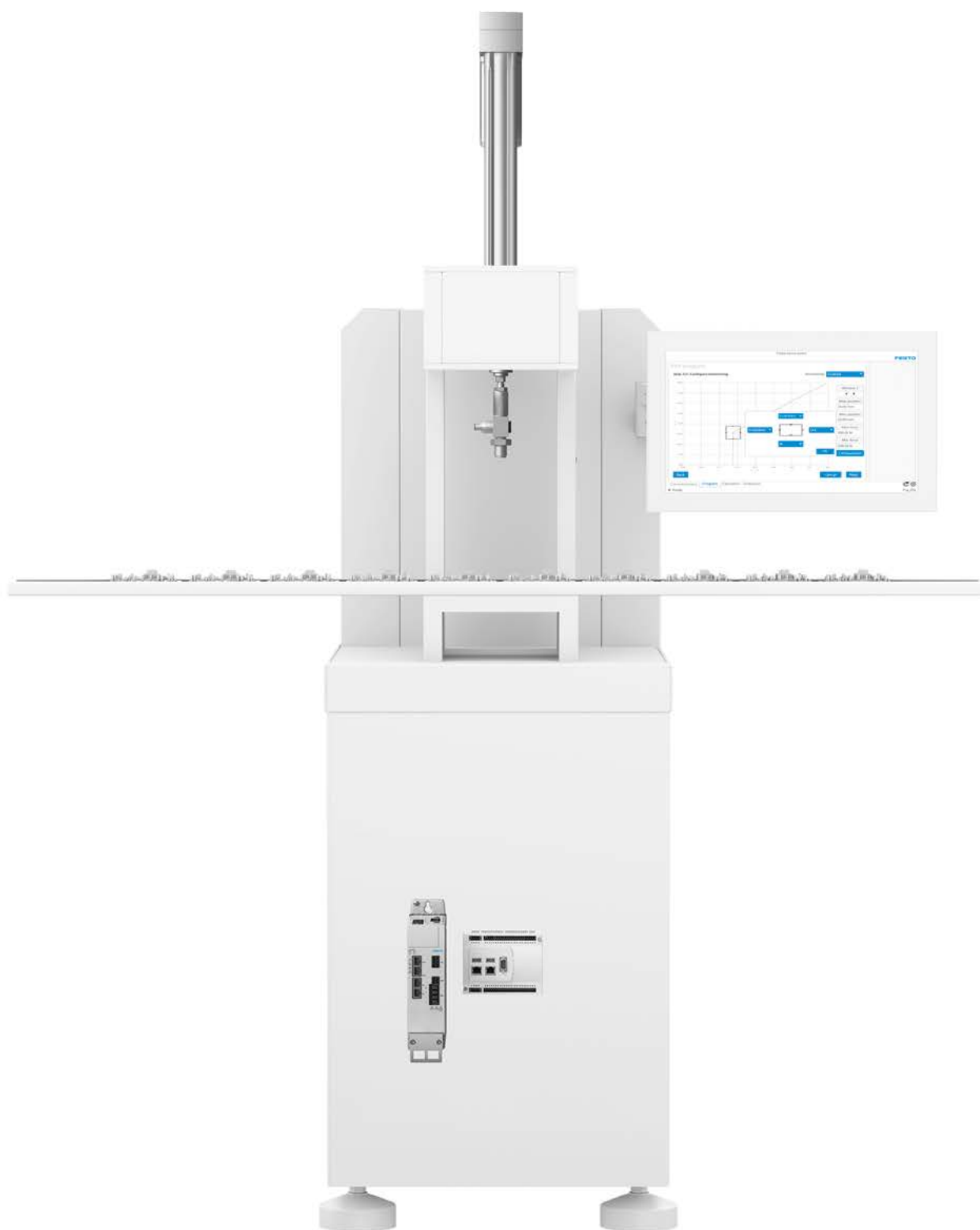

Modules

	 Function blocks	 Profile solutions
Technical data	<ul style="list-style-type: none"> • No need for tubing work because of drilled channels • Housing available in different materials • Customized design of the pneumatic interfaces to the system • Ideal for small numbers of components and variable connection options • Extremely economical, even for small quantities 	<ul style="list-style-type: none"> • Profiles in individual cross sections and lengths • Integrated ducts for straight conduction of compressed air • Common air supply to several valves or valve terminals via one duct • Bundling of working air and exhaust air without tubing, even over longer distances • Tapping off the compressed air at different points • No need for tubing work • Significantly reduced cabling work • Modular structure easy to implement • Optional: profile as mechanical fastening for further components or as supporting part of the machine frame
Description	<ul style="list-style-type: none"> • Compressed air supply for pneumatic components via drilled channels • Ideal for small numbers of pneumatic components and variable connection options • Small size and easy to service 	<ul style="list-style-type: none"> • Extruded profiles in conjunction with valves as a valve terminal • For distributing the compressed air in the machine concept • Profile cross sections for individual customers available
Just ask us: →	www.festo.com/contact	www.festo.com/contact



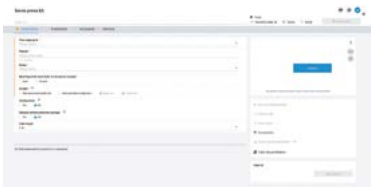

Product overview

Software tools



Configurator		<p>Design a product with numerous characteristics reliably and quickly with the help of the configurator.</p> <p>Select all the required product characteristics step-by-step. The use of logic checks ensures that only correct configurations are available for selection.</p> <p>A dynamic graphic generated on the basis of the configuration provides visual assistance in selecting the correct product characteristics.</p> <p>You will find the configurator</p> <ul style="list-style-type: none"> • at www.festo.com/catalogue/yjpk • Click the product • Click the blue „Configure product“ button
Connectivity Finder		<p>This tool can be used to find the optimum way to connect a Festo solution to your preferred (non-Festo) controller. In addition, you will be provided with expert knowledge for your selected connection option, making the integration of the Festo solution into your machine extremely easy.</p> <p>This tool can be found at → www.festo.com/x/connectivity-finder</p>

Joining technology

Function-specific systems

	 Servo press kits YJKP	 Commissioning service Gfca-Y2
Working stroke	100 ... 400 mm	
Pressing force	0 ... 17 kN	
Feed speed	0 ... 250 mm/s	
Accuracy in ± % FS	0.25 %FS	
Protocol	EtherNet/IP, OPC-UA, PROFINET IO, TCP/IP, Modbus® TCP	
Description	<ul style="list-style-type: none"> • Optimized and qualified interaction: electric cylinder, motor, servo drive, force sensor, controller and application software including the necessary accessories. • Time savings thanks to fast commissioning via the web interface • Simple configuration of even complex process sequences • Precise analysis options for the force-displacement curve to ensure the high quality of your workpiece • Easy to integrate thanks to function blocks for your system controllers 	<ul style="list-style-type: none"> • Commissioning services for the servo press kit YJKP • Available remotely or on site • Support with commissioning • Support of electrical installation • Checking of electrical connections and of travel path • Configuration and parameterization • Testing of the system, data backup and documentation • Introduction to WebVisu software
online: →	yjpk	gfca

Handling solutions

	 Balancer kits YHBP	 Control systems CMCB
Stroke range	100 ... 1990 mm	
Cylinder diameter	50 ... 200 mm	
Max. travel speed	1 m/s	
Load	25 ... 999 kg	
Operating pressure	4 ... 8 bar	
Operating pressure [MPa]	0.4 ... 0.8 MPa	
Design		Mounting plate, Control cabinet, Integrated safety relay unit
Electrical connection		Spring-loaded terminal, Push-in
Nominal operating voltage DC	24 V	24 V
Nominal operating voltage AC		230 V
Max. current consumption		1100 mA
Description	<ul style="list-style-type: none"> • Very low operating forces of just 10 N • For applications involving the movement of heavy loads in defined, repetitive sequences • Extremely fast, automatic weight detection for a wide range of variants in production processes • With safety functions • The individual components are delivered mounted in the control cabinet, on a mounting plate or unassembled 	<ul style="list-style-type: none"> • Ready-to-install control system • Available on a mounting plate with or without control cabinet housing • Variants with safety functions • Tailored to balancer kit YHBP • With connected connecting cables for the balancer kit YHBP
online: →	yhbp	cmcb



Product overview







Product overview

Air receiver tanks





Air reservoirs

		
	Air reservoirs VZS	Air reservoirs CRVZS
Volume	20 l	0.1 l, 0.4 l, 0.75 l, 10 l, 2 l, 20 l, 5 l
Information on air reservoir materials	Steel, powder-coated	High-alloy stainless steel
Conforms to standard	EN 286-1	AD 2000
Condensate drain connection	G3/8	G3/8
Description	<ul style="list-style-type: none"> • Compensation of pressure fluctuations and as accumulators in the event of sudden air consumption • Provision of large volumes of compressed air for supplying fast pulsing actuators • With connection for condensate drain • Conforms to the requirements of Directive 2014/29/EC and EN 286-1 • Operating medium compressed air, vacuum 	<ul style="list-style-type: none"> • Corrosion-resistant • Compensation of pressure fluctuations and as accumulators in the event of sudden air consumption • Provision of large volumes of compressed air for supplying fast pulsing actuators • With port for condensate drain in some cases • Food-safe, see www.festo.com/catalogue/crvzs > "Support / Downloads" tab > "Certificates" • Operating medium compressed air, vacuum
online: →	VZS	CRVZS



Pneumatic silencers

				
	Muffler AMTX	Mufflers AMTE	Mufflers U	Pneumatic mufflers UC
Operating pressure	-1 ... 7 bar	0 ... 10 bar	0 ... 10 bar	0 ... 10 bar
Operating pressure [MPa]	-0.1 ... 0.7 MPa	0 ... 1 MPa	0 ... 1 MPa	0 ... 1 MPa
Information on muffler materials		Bronze	PE, Bronze	PE
Pneumatic connection	Cartridge 12 mm	10-32 UNF-2A, 1/8 NPT, 1/4 NPT, 3/8 NPT, 1/2 NPT, G1, G1/2, G1/4, G1/8, G3/4, G3/8, M3, M5	1/8 NPT, 1/4 NPT, 3/8 NPT, 1/2 NPT, 3/4 NPT, 1 NPT, G1, G1/2, G1/4, G1/8, G3/4, G3/8, PK-3, PK-4	G1/4, G1/8, G3/8, M5, M7, QS-10, QS-3, QS-4, QS-6, QS-8
Noise level		55 ... 95 dB(A)	70 ... 90 dB(A)	58 ... 68 dB(A)
Description	<ul style="list-style-type: none"> • For VTUX valve terminal 	<ul style="list-style-type: none"> • Long or short design • Metal version • Operating medium: compressed air • High temperature resistance up to 80°C • Slim overall width • Many different variants • Universal applications 	<ul style="list-style-type: none"> • Compact design, polymer or die-cast • Barbed fitting or threaded connection • Operating medium: compressed air 	<ul style="list-style-type: none"> • For noise reduction and prevention of contamination at exhaust ports of pneumatic components • Plastic version • Operating medium: compressed air • For air solenoid valves CPE • Threaded connection or push-in sleeve for push-in fitting QS
online: →	amtx	amte	u	uc

Pneumatic silencers



	 Mufflers AMTC	 Mufflers UO	 Mufflers UOS-1, UOS-1-LF	 Mufflers UOM, UOMS
Operating pressure	0 ... 10 bar	0 ... 8 bar	0 ... 10 bar	
Operating pressure [MPa]	0 ... 1 MPa	0 ... 0.8 MPa	0 ... 1 MPa	
Information on muffler materials	PE	PE	PE	PU foam
Pneumatic connection	Cartridge 10	G1/4, G1/8, M5, M7	G1	G1/4, G3/8
Noise level	58 dB(A)		75 dB(A)	
Description	<ul style="list-style-type: none"> Attached via pin (spring clip, included in the scope of delivery of the valve) Plastic version Operating medium: compressed air 	<ul style="list-style-type: none"> Special open minimal resistance muffler For vacuum generators Facilitates trouble-free operation of the vacuum generator Operating medium: compressed air 	<ul style="list-style-type: none"> Muffler for MS6-SV, MS series Operating medium: compressed air 	<ul style="list-style-type: none"> Special open minimal resistance muffler For vacuum generators Facilitates trouble-free operation of the vacuum generator Muffler extension for extending the muffler for further noise reduction Operating medium: compressed air
online: →	amt	uo	uos	uom

Air pistols

	 Air guns LSP	 Air nozzles LPZ
Exhaust air function	Metered blowing	
Pneumatic connection	Female thread G1/4	Male thread M12x1.25
Information on housing materials	Die-cast aluminum, coated, PA6-reinforced	Aluminum, Brass, Die-cast zinc, Chrome-plated, Nickel-plated
Description	<ul style="list-style-type: none"> Precise, infinitely variable, lever-operated flow metering Interchangeable nozzles Operating medium: compressed air 	<ul style="list-style-type: none"> With protective air shield or muffler Targeted, strong air jet or powerful, focused air jet Low noise level Operating medium: compressed air
online: →	lsp	lpz



Product overview

Pressure indicators

	 <p>Visual indicators OH</p>	 <p>Pneumatic terminals, end clamps, distributors LT, LTE, LTV</p>
Operating pressure [MPa]	-0.1 ... 0.8 MPa	
Operating pressure	-1 ... 8 bar	0.1 ... 8 bar
Pneumatic connection	Barbed connector PK-3, G1/8	Barbed connector PK-3, PK-4
Pneumatic connection 2		For tubing O.D. 4, 6
Type of mounting	Control panel installation in diameter 22.5	
Description	<ul style="list-style-type: none"> • Visual indicator • Indicator colors: red, blue, yellow, or green • Aluminum or polymer • Operating medium: compressed air 	<ul style="list-style-type: none"> • Pneumatic terminal for checking incoming and outgoing signals at the controller input and output • Up to 15 distributor pieces with common air supply, for easy connection • Brass, polymer • Operating medium: compressed air
online: →	oh	lt

Manifold labels



Inscription systems

	 <p>Inscription labels ASLR, BZ, HWF, IBS, KM, KMC, MH, SBS</p>	 <p>Inscription label holders ASCF, CPV10-VI-ST, CPV14-VI-ST, CPV18-VI-ST, CPVSC1-ST, CPX-ST, VMPA1-ST, VMPA14-ST, VMPAL-ST</p>
Type of mounting	Plug-in, Can be pressed in manually	
Width		21 mm, 12 mm
Height		7 mm, 2 mm
Description	<ul style="list-style-type: none"> • For labeling items • Can be inserted in holders or carriers on suitably equipped components 	<ul style="list-style-type: none"> • Holder for inscription labels • For components without pre-assembled carriers
online: →	aslr	ascf



Product overview

Commissioning services

	 <p>Commissioning service GFCH</p>	 <p>Commissioning service GFCA-Y2</p>
Description	<ul style="list-style-type: none"> • Commissioning services for handling systems • Available for 1, 2 and 3-axis systems with and without safety module, remote or local • Inspection of the cabling, electrical and pneumatic connections as well as travel distances and energy chains • Configuration and parameterization, incl. optimization of the controller parameters and homing • Activation of components in test mode • Data backup and documentation • Instruction for machine operators 	<ul style="list-style-type: none"> • Commissioning services for the servo press kit YJKP • Available remotely or on site • Support with commissioning • Support of electrical installation • Checking of electrical connections and of travel path • Configuration and parameterization • Testing of the system, data backup and documentation • Introduction to WebVisu software
online: →	gfch	gfca

Energy saving services

	 <p>Compressed Air Energy Efficiency Audit GFAA</p>
Description	<ul style="list-style-type: none"> • TÜV-certified energy efficiency analysis of the entire compressed air system according to DIN EN ISO 11011 • Available in three packages, depending on the number of compressors present • Analysis of the current situation with weighted recommendations for improving energy efficiency • Documentation of CO2 values, costs and savings potentials • Savings of up to 60% of the compressed air costs of pneumatic systems • Improved productivity and Overall Equipment Effectiveness (OEE) • Sustainable in operation by checking the energy efficiency of the compressed air system
online: →	gfaa



Service and Support from Festo

Consistent and comprehensive support

The service and support philosophy of Festo is based on a constant analysis of the value chains of different types of customers.

Festo has built on this knowledge to develop a sophisticated portfolio that supports you along your entire value chain.

It includes numerous services such as the Energy Saving Services, customised developments of ready-to-install solutions and special designs.

Our networked digital information system now consists of a database-driven catalogue with over 30,000 products and accessories as well as tools for configuration, planning and design. Globally standardised application platforms for product lifecycle, production, logistics, sales and finance help to create integrated, global processes that will benefit you.

Engineering



- Consulting
- Design aids
- 2D/3D CAD drawings and models
- Design and sizing tools
- Selection tools
- Engineering of ready-to-install solutions

Procurement/logistics



- Festo Online Shop
- 24-hour delivery service
- Logistics optimisation service
- PrePack

Assembly and commissioning



- Commissioning axis systems
- Compressed air consumption analysis
- Commissioning and training for servo-pneumatic welding guns

Operation



- Worldwide after-sales service
- Energy Saving Services
- Compressed air quality analysis
- Support Portal with documentation for the entire product lifecycle

Are you interested in these services?

Simply ask your local contact person or find out more at [→ www.festo.com/services](http://www.festo.com/services)

You will find further information about our services there.

Festo Didactic is a leading global solution provider for basic and further technical training with a strong industrial DNA. With a state-of-the-art didactic approach, we guarantee the employability and productivity of our customers. Our product and service portfolio offers comprehensive training solutions for key technology fields such as factory and process auto-

mation. We integrate technical teaching content with expertise and training from other specialist areas such as process optimization, guidance and communication to offer you a holistic training experience. Our experienced trainers convey this relevant content, all tailored to the needs of the respective target groups.

Our offer

The goal is maximum value creation. This can be achieved through training courses on different topics and in different formats.



Technology

Development of technical skills: core technologies in factory and process automation



Organisation

Driving continuous improvement: strategic planning and process optimisation along the value chain



People

Development of behaviour and attitude: teamwork, communication skills and leadership qualities



Innovations

Skills development for the future: learning, leading and being ready for future production in the context of Industry 4.0



Overview of topics

- Pneumatics
- Hydraulics
- PLCs (programmable logic controllers)
- Electrical engineering/electronics
- Process automation
- Handling systems
- Water management
- Maintenance
- Supply chain management
- Lean production
- Process optimization
- Service and sales competence
- Industry 4.0
- Machine safety
- Battery cycle management
- Electric actuator technology



Quality offer

- Public courses
- Company-specific training courses
- Consulting
- Coaching
- Competency programs
- Business games
- Training needs analysis, certifications, blended learning concepts

+++ NEW – Electric actuator technology training +++

Basics of electric automation with CMMT (3 days)

Focus points:

- Getting to know the various motor technologies
- Theory and practice for commissioning motor controllers
- Knowledge and application of tools such as Electric Motion Sizing, FESTO Automation Suite
- Design and construction of electric actuator systems (motor, axis and CMMT motor controller, safety functions)
- Integration and control, e.g. on the SIEMENS TIA Portal
- Recognising and rectifying simple errors
- Evaluating the driving behavior of electric actuators
- Configuring and commissioning the CMMT motor controller
- Practical exercises in small groups



What are you waiting for? Contact us:

Festo Didactic SE | Rechbergstraße 3 | D-73770 Denkendorf | did@festo.com

→ www.festo-didactic.com

What must be taken into account when using Festo products?

The limit values specified in the technical data and any specific safety instructions must be adhered to by the user in order to ensure correct functioning.

The pneumatic components must be supplied with properly prepared compressed air, without aggressive media.

Take the ambient conditions at the location of use into consideration. Corrosive, abrasive and dusty environments (e.g. water, ozone, grinding dust) reduce the product's service life.

Check the resistance of the materials of Festo products with regard to the media used or surrounding them.

When using Festo products in safety-related applications, it is always mandatory to observe and comply with national and international laws, regulations, e.g. the Machinery Directive, with the corresponding standard references, the rules of the employers' liability insurance association and the relevant international regulations.

Unauthorised conversions or modifications to products and systems from Festo constitute a safety risk and are thus not permitted.

Festo cannot accept any liability for any damage resulting from this.

You should contact Festo if one of the following applies to your application:

- The ambient conditions and conditions of use or the operating medium differ from the specified technical data.
- The product is to perform a safety function.
- A risk or safety analysis is required.
- In case of uncertainty about the suitability of the product for the intended use.
- In case of uncertainty about the suitability of the product for use in safety applications

All technical information is correct at the time of printing.

All contents, texts, depictions, illustrations and drawings contained in this document are the property of Festo SE & Co. KG, and are therefore protected by copyright.

Any duplication, processing, translation, microfilming or storage and processing in electronic systems without the consent of Festo SE & Co. KG is prohibited.

Subject to change due to continuous technical development.



ABB® is a registered trademark of ABB Asea Brown Boveri Ltd. in certain countries.

Allen-Bradley® is a registered trademark of Rockwell Automation, Inc. in certain countries.

ANSI® is a registered trademark of the American National Standards Institute, Incorporated in certain countries.

AS-Interface® is a registered trademark of the nonprofit trade association AS-International in certain countries.

ASME® is a registered trademark of The American Society of Mechanical Engineers in certain countries.

Beckhoff® is a registered trademark of Hans Beckhoff in certain countries.

Cage Clamp® is a registered trademark of WAGO Kontakttechnik GmbH & Co. KG in certain countries.

CANopen® is a registered trademark of CAN in AUTOMATION - International Users and Manufacturers Group e.V. in certain countries.

CC-LINK® is a registered trademark of Mitsubishi Electric Corporation in certain countries.

CIROS® is a registered trademark of the Dortmunder Initiative zur rechnerintegrierten Fertigung (RIF) e.V. in certain countries.

CODESYS® is a registered trademark of 3S-Smart Software Solutions GmbH in certain countries.

DeviceNet® is a registered trademark of ODVA, INC. in certain countries.

EasyIP® is a registered trademark of Novagraaf Nederland B.V. in certain countries.

ECOLAB® is a registered trademark of Ecolab USA Inc. in certain countries.

EHEDG European Hygienic Engineering & Design Group® is a registered trademark of Stichting Ehedg in certain countries.

EnDat® is a registered trademark of Dr. Johannes Heidenhain GmbH in certain countries.

ePLAN electric P8® and ePLAN fluid® are registered trademarks of EPLAN Software & Service GmbH & Co. KG in certain countries.

EtherCAT® is a registered trademark of Beckhoff Automation GmbH in certain countries.

Ethernet POWERLINK® is a registered trademark of ABB ASEA BROWN BOVERI LTD COMPANY in certain countries.

EtherNet/IP® is a registered trademark of ODVA, INC. in certain countries.

Excel® is a registered trademark of the Microsoft Corporation in certain countries.

Fin Ray® is a registered trademark of EvoLogics GmbH in certain countries.

HACCP - Hazard Analysis Critical Control Points® is a registered trademark of Rizzo Graziana in certain countries.

HARAX® is a registered trademark of HARTING Electric GmbH & Co. KG in certain countries.

HIPERFACE® is a registered trademark of Sick Stegmann GmbH in certain countries.

International Electrotechnical Commission® is a registered trademark of the International Electrotechnical Commission in certain countries.

INTERBUS® is a registered trademark of Phoenix Contact GmbH & Co. KG in certain countries.

IO-Link® is a registered trademark of Profibus Nutzerorganisation e.V. in certain countries.

JohnsonDiversey® is a registered trademark of S.C. Johnson & Son, Inc. in certain countries.

Loctite® is a registered trademark of Henkel IP & Holding GmbH in certain countries.

Makrolon® is a registered trademark of Covestro Deutschland AG in certain countries.

Microsoft® is a registered trademark of the Microsoft Corporation in certain countries.

The aforementioned brands are registered/pending trademarks of the respective trademark owner in certain countries. All other trademarks not listed here are the property of their respective owners in certain countries.

MITSUBISHI® is a registered trademark of Mitsubishi Corporation in certain countries.

Modbus® is a registered trademark of Schneider Electric USA, Inc in certain countries.

NAMUR® is a registered trademark of NAMUR - Interessengemeinschaft Automatisierungstechnik der Prozessindustrie e.V. in certain countries.

ODVA® is a registered trademark of ODVA, Inc in certain countries.

OPC UA® is a registered trademark of the OPC Foundation in certain countries.

PROFIsafe® is a registered trademark of Siemens Aktiengesellschaft in certain countries.

Rockwell Automation® is a registered trademark of Rockwell Automation, Inc. in certain countries.

SERCOS interface® is a registered trademark of SERCOS International e.V. in certain countries.

SIMATIC® is a registered trademark of Siemens Aktiengesellschaft in certain countries.

SucoNet® is a registered trademark of Eaton Electrical IP GmbH & Co. KG in certain countries.

Systainer® is a registered trademark of TTS Tooltechnic Systems AG & Co. KG in certain countries.

Teflon® is a registered trademark of The Chemours Company FC in certain countries.

TORX® is a registered trademark of Acument Intellectual Properties, LLC in certain countries.

TwinCAT® is a registered trademark of Beckhoff Automation GmbH in certain countries.

UL® is a registered trademark of Underwriters Laboratories Inc. in certain countries.

VDMA® is a registered trademark of Verband Deutscher Maschinen- und Anlagenbau (VDMA) e.V. in certain countries.

Viton® is a registered trademark of The Chemours Company FC in certain countries.

Vulkollan® is a registered trademark of Covestro Deutschland AG in certain countries.

Windows® is a registered trademark of the Microsoft Corporation in certain countries.